



---

# R&D-PROGRAMME 89

---

## Handling and final disposal of nuclear waste.

Programme for research development  
and other measures.

September 1989

---

**SVENSK KÄRNBRÄNSLEHANTERING AB**

*SWEDISH NUCLEAR FUEL AND WASTE MANAGEMENT CO*

BOX 5864 S-102 48 STOCKHOLM

TEL. 08-665 28 00 TELEX 13108-SKB TELEFAX 08-661 57 19

# **Handling and Final Disposal of Nuclear Waste.**

**Programme for Research, Development  
and other Measures.**

September 1989

**Part I General**

**Part II Programme 1990-1995**

# CONTENTS PARTS I – II

## Part I GENERAL

### FOREWORD

	<b>INTRODUCTION</b>	<b>9</b>
<b>1</b>	<b>PREMISES</b>	<b>11</b>
<b>2</b>	<b>WASTE FROM THE SWEDISH NUCLEAR POWER PROGRAMME</b>	<b>13</b>
<b>3</b>	<b>MANAGEMENT OF RADIOACTIVE WASTE FROM NUCLEAR POWER PLANTS</b>	<b>17</b>
<b>4</b>	<b>FINAL DISPOSAL OF SPENT NUCLEAR FUEL. OVERVIEW OF GOALS, PLAN FOR ACTIVITIES AND STATE OF KNOWLEDGE</b>	<b>25</b>
<b>5</b>	<b>FINAL DISPOSAL OF SPENT NUCLEAR FUEL. SUMMARY OF PLANNED RESEARCH AND DEVELOPMENT 1990 – 1995</b>	<b>39</b>
<b>6</b>	<b>DECOMMISSIONING OF NUCLEAR POWER PLANTS</b>	<b>49</b>
	<b>References</b>	<b>53</b>
	<b>Appendix</b>	<b>55</b>

## Part II PROGRAMME 1990–1995

<b>1</b>	<b>GENERAL</b>	<b>65</b>
<b>2</b>	<b>SITING OF FINAL REPOSITORY FOR SPENT FUEL AND OTHER LONG-LIVED WASTE</b>	<b>67</b>
<b>3</b>	<b>SAFETY ASSESSMENTS</b>	<b>73</b>
<b>4</b>	<b>REPOSITORY DESIGN</b>	<b>83</b>
<b>5</b>	<b>ENGINEERED BARRIERS</b>	<b>89</b>
<b>6</b>	<b>PROPERTIES OF THE ROCK</b>	<b>103</b>
<b>7</b>	<b>CHEMISTRY</b>	<b>127</b>
<b>8</b>	<b>METHOD AND INSTRUMENT DEVELOPMENT</b>	<b>139</b>
<b>9</b>	<b>HARD ROCK LABORATORY</b>	<b>151</b>
<b>10</b>	<b>THE STRIPA PROJECT</b>	<b>159</b>
<b>11</b>	<b>NATURAL ANALOGUES</b>	<b>165</b>
<b>12</b>	<b>BIOSPHERE STUDIES</b>	<b>169</b>
<b>13</b>	<b>INTERNATIONAL COOPERATION</b>	<b>173</b>
	<b>References</b>	<b>181</b>

### BACKGROUND REPORTS

<b>I</b>	Reviews of R&D-Programme 86 Summaries and SKB's comments (in Swedish)	
<b>II</b>	Hard Rock Laboratory	

## FOREWORD

The Act on Nuclear Activities (SFS 1884:3) prescribes in its Section 12 that a programme shall be prepared for the comprehensive research and development and other measures that are required to safely handle and finally dispose of the radioactive waste from the nuclear power plants. The responsibility lies primarily with the owners of the nuclear power plants. These owners have commissioned SKB to prepare the prescribed programme. According to Section 25 of the Ordinance on Nuclear Activities (SFS 1984:14), this programme shall be submitted to the National Board for Spent Nuclear Fuel during the month of September every third year beginning in 1986.

The purpose of this second programme is to fulfil the above obligations.

Stockholm in September 1989

**SVENSK KÄRNBRÄNSLEHANTERING AB**

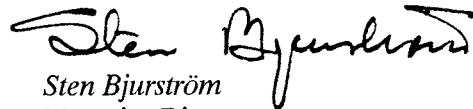

*Sten Bjurström*  
Managing Director



*/Per-Eric Ahlström/*  
Research Director

# CONTENTS PART I

	Page
<b>FOREWORD</b>	
<b>INTRODUCTION</b>	<b>9</b>
<b>1 PREMISES</b>	<b>11</b>
1.1 Guidelines for Swedish Radioactive Waste Management	11
1.2 Applicable Legislation etc	11
1.3 Background	11
1.4 R&D-Programme 86 – Expert Review	12
<b>2 WASTE FROM THE SWEDISH NUCLEAR POWER PROGRAMME</b>	<b>13</b>
2.1 Classification of Radioactive Waste	13
2.2 Waste from the Nuclear Power Plants	13
2.2.1 Spent Nuclear Fuel	13
2.2.2 Operational Waste	13
2.2.3 Core Components and Reactor Internals	14
2.2.4 Decommissioning Waste	14
2.3 Other Radioactive Waste	14
2.3.1 Waste from CLAB and BS	14
2.3.2 Waste from Studsvik	14
2.3.3 Waste from Reprocessing	15
2.4 Estimated Waste Quantities	15
<b>3 MANAGEMENT OF RADIOACTIVE WASTE FROM NUCLEAR POWER PLANTS</b>	<b>17</b>
3.1 General	17
3.2 Possible Final Disposal Principles	17
3.3 Facilities and Systems in Operation	18
3.3.1 Final Repository for Reactor Waste, SFR	18
3.3.2 Central Interim Storage Facility for Spent Nuclear Fuel, CLAB	19
3.3.3 The Transportation System	19
3.4 Future Facilities and Systems	20
3.4.1 Encapsulation Plant for Spent Fuel, BS	20
3.4.2 Final Repository for Long-lived Waste, SFL	20
3.5 Timetable	22
<b>4 FINAL DISPOSAL OF SPENT NUCLEAR FUEL. OVERVIEW OF GOALS, PLAN FOR ACTIVITIES AND STATE OF KNOWLEDGE</b>	<b>25</b>
4.1 Goals of the Research Work – General	25
4.2 Some Points of Departure for the R&D-Work	25
4.3 Overall Plan for the R&D-Work	26
4.3.1 R&D-Programme 86	26
4.3.2 Programme for R&D and Other Measures	26
4.4 State of Knowledge Regarding Safety Assessments	28
4.4.1 Goals of the Work with Safety Assessments	29
4.4.2 State of Development for Safety Assessments	29

	Page	
4.5	State of Knowledge Regarding Engineered Barriers	30
4.5.1	Goals of the Research Regarding Engineered Barriers	30
4.5.2	Design of the Final Repository	30
4.5.3	Waste Forms	31
4.5.4	Canister	31
4.5.5	Buffer and Backfill Material	32
4.6	State of Knowledge within the Geoscientific Field	33
4.6.1	Goals of the Geoscientific Studies	33
4.6.2	Groundwater Movements in the Rock	33
4.6.3	Stability of the Rock	34
4.6.4	Methods and Instrument Development	35
4.6.5	Hard Rock Laboratory	35
4.7	Chemistry	36
4.7.1	Goals of R&D in the Chemistry Field	36
4.7.2	Present-day State of Knowledge	36
4.8	Biosphere Studies	37
4.8.1	Goals of Biosphere Studies	37
4.8.2	Present-day State of Knowledge	37
<b>5</b>	<b>FINAL DISPOSAL OF SPENT NUCLEAR FUEL. SUMMARY OF PLANNED RESEARCH AND DEVELOPMENT 1990 – 1995</b>	<b>39</b>
5.1	General	39
5.2	Research Areas and Projects	39
5.3	Research Programme 1990–1995	39
5.3.1	Siting of the Final Repository	41
5.3.2	Safety Assessment	41
5.3.3	Design of the Final Repository	42
5.3.4	Engineered Barriers	42
5.3.5	Properties of the Rock	43
5.3.6	Method and Instrument Development	44
5.3.7	Hard Rock Laboratory	44
5.3.8	Chemistry	45
5.3.9	Natural Analogues	46
5.3.10	Biosphere Studies	46
5.3.11	International Cooperation	46
5.4	Execution of the Programme	47
<b>6</b>	<b>DECOMMISSIONING OF NUCLEAR POWER PLANTS</b>	<b>49</b>
6.1	Background	49
6.2	Goals and Overall Plan	49
6.3	Ongoing Work	50
6.3.1	Sweden	50
6.3.2	Other Countries	50
6.4	Research Programme 1990–1995	52
	<b>REFERENCES</b>	<b>53</b>
	<b>Appendix</b>	<b>55</b>

# INTRODUCTION

The Act on Nuclear Activities (SFS 1984:3) prescribes the owners of the Swedish nuclear power plants to jointly prepare a comprehensive programme for the research and development work and other measures required for the safe management and disposal of the waste from nuclear power production.

The Swedish Nuclear Fuel and Waste Management Company (SKB) has been commissioned by its owners, the Swedish nuclear utilities, to develop, plan, construct and operate facilities and systems for the management and disposal of spent nuclear fuel and radioactive waste from the Swedish nuclear power plants.

SKB is also responsible for the extensive research activities within the field of nuclear waste which the Swedish nuclear power producers are required to carry out.

SKB is owned by Forsmarks Kraftgrupp AB (FKA), OKG AB, Sydsvenska Värmekraft AB (SVAB, owned by Sydkraft AB) and Vattenfall (the Swedish State Power Board).

The above utilities have commissioned SKB to prepare the programme for research and development prescribed by the Nuclear Activities Act. The programme, presented in this report, provides an overview of all measures up to the implemented final disposal. A more detailed account is given of the research programme for the period 1990–1995.

SKB's research through 1983 was presented in the KBS-3 Report, which was submitted in support of the applications for fuelling permits for Forsmark 3 and Oskarshamn 3.

In 1986, SKB submitted the first research programme pursuant to the Nuclear Activities Act, R&D-Programme 86. This report provided a brief account of research results obtained after the publication of the KBS-3 Report in May 1983.

This research programme, R&D-Programme 89, provides an account of research results obtained after

September 1986 when R&D-Programme 86 was published. A more detailed account of these results is provided in the SKB series of Technical Reports.

The comments made in connection with the expert review of R&D-Programme 86 have been taken into account in the preparation of R&D-Programme 89.

For those parts of the waste system that have already been taken into operation – transportation and handling systems, central interim storage facility for spent nuclear fuel (CLAB) and final repository for reactor waste (SFR) – the research and development stage has already largely been passed. The programme presented here therefore pertains primarily to the treatment and final disposal of spent fuel and the decommissioning of nuclear power plants.

The report is divided into two parts.

Part I – General – presents the premises for waste management in Sweden and the waste types that are produced in the Swedish nuclear power programme. A brief description is then provided of the measures required for the handling and final disposal of various waste forms. The comments made in the reviews of R&D-Programme 86 particularly requested an overview of the present-day state of knowledge within research and development. Such an overview is presented a summary of planned research and development for the period 1990–1995 and an account of measures for the decommissioning of nuclear power plants concludes Part I.

Part II describes the research programme for the years 1990–1995.

The Act on Nuclear Activities requires that the programme “present a survey of all measures that may be necessary” and “specify the measures that are intended to be taken within a period of at least six years”. Part I is intended to fill the first requirement, while Part II fulfils the requirement on a detailed six-year plan.

# 1 PREMISES

## 1.1 GUIDELINES FOR SWEDISH RADIOACTIVE WASTE MANAGEMENT

The goal of radioactive waste management in Sweden is to dispose of all radioactive waste products generated at the Swedish nuclear power plants in a safe manner.

The following general guidelines apply to the waste management system:

- The radioactive waste products shall be disposed of in Sweden.
- The spent nuclear fuel shall be temporarily stored and finally disposed of without reprocessing.
- Technical systems and facilities shall fulfil high standards of safety and radiation protection and satisfy the requirements of the Swedish authorities.
- The systems for waste management shall be designed so that requirements on the control of fissionable material can be fulfilled.
- In all essential respects, the waste problem shall be solved by the generation that utilizes electricity production from the nuclear power stations.
- A decision on the design of the final repository for spent nuclear fuel shall not be taken until around the year 2000 so that it can be based on a thorough understanding.
- The necessary technical solutions for the disposal of Swedish wastes shall be developed within the country, at the same time as available foreign knowledge shall be gathered.
- The efforts shall be guided by the regulatory authorities' continuous review and assessment and the directives issued by them.
- The activities shall be conducted openly and with good public insight.

## 1.2 APPLICABLE LEGISLATION ETC

The obligations of the owners of nuclear power reactors with regard to handling and final storage of radioactive waste are regulated in the Act on Nuclear Activities, in the Ordinance on Nuclear Activities and in certain licences and guidelines issued by the Government. An overview of the most important provisions is provided in the Appendix.

The provisions and guidelines entail in brief that the owners of nuclear power plants shall ensure that:

- the necessary measures are taken in order to safely handle and finally dispose of generated nuclear waste and to decommission and dismantle nuclear power plants and appurtenant facilities in a safe manner,
- the comprehensive research and development activities that are required to carry out these measures are conducted, including studies of alternative methods for handling and disposal,
- a programme for research and development and other measures is prepared every third year starting in 1986, including an account of the results of completed research.

## 1.3 BACKGROUND

Research regarding the handling and final disposal of radioactive waste started on a large scale in Sweden in connection with the establishment of the National Council for Radioactive Waste (PRAV) in 1975. The Council was created on the recommendation of the AKA Committee /1-1/. The research was intensified in connection with the enactment of the "Stipulation Act" in 1976/77, when the KBS (Nuclear Power Safety) Project was started by the nuclear utilities. The project was administratively tied to SKB. The project developed two final disposal methods: KBS-1 for vitrified high-level reprocessing waste (1977) /1-2/ and KBS-2 for the handling and final storage of unprocessed spent nuclear fuel (1978) /1-3/.

The KBS-1 report was submitted in support of applications for fuel-loading permits for the Ringhals 3 and 4 and Forsmark 1 and 2 reactors. The Government issued fuel-loading permits in 1979 and 1980.

When the Financing Act /1-4/ entered into force, the National Council for Radioactive Waste was abolished and the National Board for Spent Nuclear Fuel (NAK, later SKN) was created. The purpose of this Board is to review, assess and supervise the activities of the nuclear utilities (SKB) within the waste management field.

In 1983, SKB presented a new report on the final disposal of spent nuclear fuel. The report was based on the same method as that described in KBS-2, but the new report, KBS-3, was based on a much broader and deeper body of knowledge /1-5/.

The KBS-3 report was presented in support of the applications for fuel-loading permits for the Forsmark 3 and Oskarshamn 3 reactors. The Government granted these licences under the new Act on Nuclear Activities /1-6/ in June 1984. A research programme /1-7/



prepared by SKB in February 1984 was also submitted as a support for the licence application.

In September 1986, SKB presented the first research programme (R&D-Programme 86) under the Act on Nuclear Activities.

The results of SKB's research work are reported continuously in SKB's technical reports. Annual summaries are included in the SKB Annual Report /1-8,9,10,11,12/.

## **1.4 R&D-PROGRAMME 86 – EXPERT REVIEW**

After R&D-Programme 86 had been submitted to SKN in September 1986, the programme was sent out for review and comment to a large number of institutions and individuals both in and outside Sweden. The review

period expired on February 1, 1987. Some 30 or so Swedish and 10 or so foreign review statements were received by SKN. On the basis of these and its own judgements, SKN prepared a special review report, which was submitted to the Government in May 1987. In December, the Government decided that the SKB programme fulfils the requirements of the Act on Nuclear Activities, that the programme should serve as a basis for continued work, and that SKN's viewpoints should be taken into account to as great an extent as possible.

A summary of SKB comments on the review statements received is provided in one of the background reports to this programme. Wherever possible, SKB has taken heed of the comments on R&D-Programme 86 in the present research programme.

## 2 WASTE FROM THE SWEDISH NUCLEAR POWER PROGRAMME

### 2.1 CLASSIFICATION OF RADIOACTIVE WASTE

Radioactive waste from the Swedish nuclear power programme varies widely in terms of form and activity content, all the way from virtually inactive trash to spent fuel, which has a very high activity content. Different waste forms therefore impose different demands on handling and final disposal.

From the handling viewpoint, it is practical to distinguish between low-level, intermediate-level and high-level waste. Low-level waste can be handled and stored in simple packages, without any special protective measures. Intermediate-level waste must be radiation-shielded for safe handling. High-level waste requires not only radiation shielding, but also cooling for a certain period of time in order to permit safe storage.

From the viewpoint of final disposal, the half-life of the radionuclides contained in the waste is of great importance. A distinction is made between short- and long-lived wastes.

Short-lived waste mainly contains radionuclides with a half-life shorter than 30 years, ie it will have decayed to a harmless level within a few hundred years. This waste will be deposited in the Swedish Final Repository for Reactor Waste, SFR, at Forsmark. Some very low-level and short-lived waste can be dumped on a simple landfill (shallow land burial).

Long-lived waste remains radioactive for thousands of years or more and requires a more qualified final disposal.

Table 2-1 shows an example of the classification of wastes from the Swedish nuclear power programme on the basis of activity and life.

### 2.2 WASTE FROM THE NUCLEAR POWER PLANTS

The waste from the nuclear power plants is usually divided into the following groups with regard to its subsequent handling:

- Spent nuclear fuel.
- Operational waste (reactor waste).
- Core components and reactor internals.
- Decommissioning waste.

Table 2-1. Example of classification of radioactive wastes.

Life	Radioactivity		
	High	Intermediate	Low
Long (thousands of years)	Spent fuel	Certain core components	Maintenance waste
Intermediate (a few hundred years)		Ion exchange resins Discarded components Decommissioning waste	

#### 2.2.1 Spent Nuclear Fuel

Most of the radioactive substances (approx 99%) that are formed in a nuclear power plant are present in the spent fuel.

Some of the fuel types used in Swedish power reactors are described in KBS-3 /2-1/. A fuel assembly for a boiling water reactor (BWR) contains approximately 180 kg of uranium, while an assembly for a pressurized water reactor (PWR) contains about 460 kg of uranium. The design differs somewhat between different manufacturers and between fuel produced at different times. From the viewpoint of final disposal, the differences between different fuel types are generally of no consequence. This also applies to odd fuel assembly types with oxide fuel clad in zircaloy, for example MOX fuel and Ågesta fuel.

The spent fuel consists mainly of unfissioned uranium, while most of the radioactivity comes from the fission products and transuranics present in the fuel. Examples of composition, activity level and other data for spent fuel are given in /2-2/.

The high level of activity in spent fuel means that it continues to emit heat for a long time after it has been discharged from the reactor. This is of great importance in determining how the spent fuel will be handled and disposed of. Between one and forty years after discharge, the residual power decreases by a factor of 10. It then takes another 1 000 years or so for the residual power to decrease by yet another factor of 10.

#### 2.2.2 Operational Waste

The category "operational waste" includes a number of different types of waste obtained in connection with the

operation and maintenance of the reactors. The main constituent is ion exchange resins and filters obtained continuously during operation from cleanup of the reactor water. The operational waste also includes replaced components from the reactor systems as well as protective clothing, plastic, paper, insulating materials etc that have been used in areas where activity is present and may therefore be contaminated.

The operational waste is low and intermediate-level and mainly contains radionuclides with half lives shorter than 30 years. The concentration of long-lived radionuclides is very low. The activity in the operational waste will therefore decay to a harmless level within a few hundred years or less.

The operational waste is conditioned at the nuclear power plants to give it a packaging and form that is appropriate for its subsequent handling. Different conditioning methods are applied at different nuclear power plants. This is described in greater detail in /2-3/.

Similar waste also comes from the operation of the central interim storage facility for spent nuclear fuel, CLAB, and from Studsvik.

### **2.2.3 Core Components and Reactor Internals**

Components located in or near the core inside the reactor vessel are exposed to a strong neutron flux and thereby obtain a high induced activity. Some of these components, for example neutron detectors, are successively replaced at intervals of a few years. Others, for example the moderator tank, are used for the entire lifetime of the reactor and only become waste when the reactors are dismantled.

Fuel channels and other structural components in the fuel assemblies are included among the core components here.

The core components and some reactor internals have a very high radiation level when they are discharged from the reactor. This radioactivity is dominated by cobalt-60, which has a half-life of about five years, which means that the radiation level declines by a factor of 1 000 in 50 years. Core components and reactor internals also contain some radionuclides with a long half-life, such as nickel-59 (90 000 years) and niobium-94 (20 000 years). The radiotoxicity of these nuclides is lower than that of the transuranics, and requirements on the final disposal of these components are therefore lower than for spent fuel.

### **2.2.4 Decommissioning Waste**

When a nuclear power plant is finally shut down, parts of the facility are radioactive and must therefore be disposed of in a safe manner. These parts include the reactor vessel and reactor internals, as well as the concrete immediately adjacent to the reactor vessel containing

induced activity. They also include various parts of the reactor systems that have been radioactively contaminated. However, most of the plant has not come into contact with radioactivity and the waste can therefore be handled like normal waste from the dismantling of industrial facilities.

The waste obtained from decommissioning consists primarily of components of steel, eg tanks, pipes and valves from the reactor's process systems. It also includes large quantities of concrete, 90% of which is inactive. The dismantling and demolition work also gives rise to a certain amount of process waste from water and air cleaning systems that are in operation during the decommissioning period.

The radioactive decommissioning waste is all low- and intermediate level. However, the activity level varies considerably between different parts. A large portion of the metal scrap can be released for unrestricted reuse. The concrete and some other materials can be deposited on an ordinary industrial landfill, possibly adjacent to the reactor facility. However, most of the active decommissioning waste has an activity level that warrants deposition in SFR. As mentioned above, certain highly radioactive reactor internals are also obtained from decommissioning and require special treatment.

A large portion of the activity consists of surface contamination, which can be removed by means of various decontamination methods. The quantity of material that can be declassified is therefore dependent on how far the decontamination work is carried.

## **2.3 OTHER RADIOACTIVE WASTE**

Besides the nuclear power plants, the main sources of radioactive waste in Sweden are the central interim storage facility for spent nuclear fuel, CLAB, and the coming treatment plant for spent fuel, BS, as well as the Studsvik Research Facility. Waste from the use of radioactive materials in industry, medical care and research is also collected at Studsvik.

### **2.3.1 Waste from CLAB and BS**

The waste from CLAB is of the same kind as the operational waste from the reactors. It is also treated in the same manner. Similar waste will also be obtained from the treatment plant for spent fuel, BS.

### **2.3.2 Waste from Studsvik**

Waste from the operation of the R2 research reactor as well as from the R&D-activities concerned with radioactive products, such as fuel rods, is generated in Studsvik. The fuel that is used in R2 is sent back to the USA and therefore does not have to be disposed of in

Sweden. Other waste from R2 is similar to the operational waste from the nuclear power plants and is treated in a similar manner.

However, the waste from the R&D-activities is of a different character. Some of this waste contains considerable quantities of long-lived transuranics and therefore requires a similar final disposal as the spent fuel. Fuel from the Ågesta reactor as well as from the R1 research reactor is also stored in Studsvik. A transfer of Ågesta fuel and encapsulated fuel residues to CLAB has been going on since 1987.

### 2.3.3 Waste from Reprocessing

In the reprocessing of spent nuclear fuel, uranium and plutonium are separated from fission products and other transuranics. This process gives rise to both high-level vitrified waste, which contains most of the radioactivity, and low- and intermediate-level waste solidified in cement or bitumin.

Most of the waste from reprocessing contains large quantities of transuranics and is therefore long-lived.

The Swedish power industry has reprocessing contracts with BNFL in Great Britain and with COGEMA in France. Only the contracts with COGEMA call for the waste to be returned to Sweden. SKB does not currently plan to exercise these contracts but is working instead to find someone to take them over. Reprocessing waste is therefore no longer included in the Swedish plans for the back end of the nuclear fuel cycle.

## 2.4 ESTIMATED WASTE QUANTITIES

The estimated quantity of radioactive waste from the Swedish nuclear power programme has been reported in PLAN 89 /2-4/. The results are shown in Table 2-2.

Table 2-2. Main types of radioactive waste products.

Product	Main source	Unit	No. of units	Volume in final repository m <sup>3</sup>
Spent fuel		tonnes U	7 800	
Alpha-contaminated waste	Low- and intermediate-level waste from Studsvik	drums	18 000	6 000
Core components	Reactor internals	concrete moulds	2 400	19 700
Low- and intermediate-level waste	Operational waste from nuclear power plants and treatment plants	drums and moulds	60 000	95 000
Decommissioning waste	From decommissioning of nuclear power plants and treatment plants	10–20 m <sup>3</sup> containers	5 600	114 000

# 3 MANAGEMENT OF RADIOACTIVE WASTE FROM NUCLEAR POWER PLANTS

## 3.1 GENERAL

The safe handling and final disposal of the waste from nuclear power requires planning, construction and operation of a number of facilities and systems. Figure 3-1 illustrates schematically the different parts of the planned Swedish waste management system. These parts are described in detail in the annual report of the costs for management of the radioactive waste products of nuclear power, PLAN 89, which the power utilities have submitted through SKB /3-1/. Only a brief overview is given here.

The facilities are also planned to accommodate the radioactive waste in Sweden that does not come from electricity-generating reactors, see Chapter 2.

The design of the system is based on the following fundamental principles:

- Short-lived waste will be disposed of as soon as possible after it has been generated.
- Spent fuel will be stored for about 40 years before it is placed in a final repository. This will limit heat generation in the final repository.

- Other long-lived waste will be disposed of in connection with the final disposal of spent fuel.

Essential parts of the waste management system are already in operation, namely the central interim storage facility for spent nuclear fuel, CLAB, the final repository for reactor waste, SFR, and the transportation system. CLAB and SFR are planned to be expanded during the latter half of the 1990s so that they can accommodate all spent fuel and waste from the Swedish nuclear power programme.

The parts remaining are a treatment plant for spent fuel, BS, and a final repository for long-lived waste, SFL. These facilities will not be built until after 2010, according to present-day plans. Extensive R&D-work is being conducted for these parts of the system aimed at finding a suitable design and site, see Chapters 4 and 5.

Management of the radioactive waste products of nuclear power also includes decommissioning of the nuclear power plants and other facilities when they have been taken out of operation and final disposal of the waste from decommissioning. See Chapter 6.

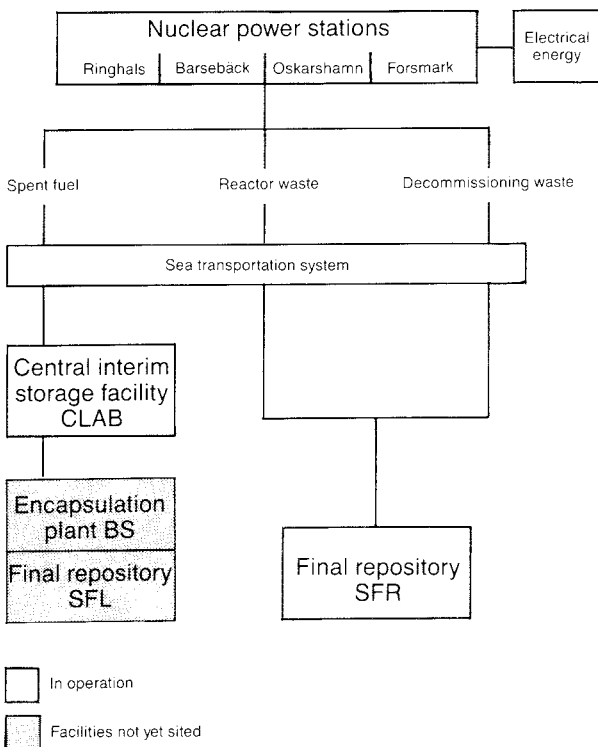

Figure 3-1. The Swedish waste management system.

## 3.2 POSSIBLE FINAL DISPOSAL PRINCIPLES

A number of possible principles for final disposal are described in SKN PLAN 87 and in SKB PLAN 82 Part 1 /3-2, 3-3/. A condensed summary of the discussion in these references is provided below.

The concept “final disposal” entails that the waste is to be isolated without any requirements on surveillance and in such a manner that it is difficult or impossible to get at. However, a monitored storage is included as an unavoidable link in the handling chain. It can extend over a very long period of time without any major technical or safety-related problems. Sooner or later, however, the waste must be transferred to a repository without supervision and the repository must be sealed. We cannot demand or assume that future generations will bear the burden of surveillance and maintenance of the repository. A repository that is dependent for its safety on continuous surveillance and maintenance measures cannot be regarded as a final repository.

In connection with the final disposal of spent fuel, safeguarding of fissionable material must also be provided for. This means that the final repository must be designed and sealed in such a manner that recovery of the fissionable material involves such extensive and

well-planned efforts that a covert retrieval can be ruled out.

The following principles for final disposal of radioactive waste have been proposed in the international discussion:

- Deep disposal in continental geological formations.
- Disposal in shallow soil or rock strata.
- Disposal beneath the seabed in deep-sea sediments.
- Dumping at sea.
- Disposal in or under continental ice sheets (eg Antarctica).
- Launching into space (or to the sun).

Disposal of long-lived waste at great depth (several hundred metres or more) in continental geological formations is the principle that is prioritized by all countries conducting extensive research and development on disposal of radioactive waste. It is also the only principle that is deemed available and feasible as far as Sweden is concerned within the foreseeable future.

Disposal in shallow soil or rock strata (a few tens of metres up to 100 metres deep) entails restrictions on land use following disposal. This principle can only be applied to short lived waste or waste with low radiotoxicity. The principle is applied in SFR.

Disposal beneath the seabed in deep-sea sediments beyond the continental shelf is being studied by a number of countries, included in international collaboration under the auspices of OECD/NEA. This principle, which has certain attractive features, would presumably require international agreements or conventions and cannot be applied as an independent Swedish solution.

Sea dumping or disposal in or under continental ice sheets is not feasible in Sweden.

Launching into space would certainly be a convincing way to isolate the waste, but the reliability of the launching procedure must be guaranteed. It is also far too expensive to be of interest for Sweden.

Another conceivable final treatment principle would involve rendering the long-lived radioactive materials in the waste harmless by means of nuclear "combustion" (transmutation to stable or short-lived nuclides). However, such a system requires advanced reprocessing as well as reactors with a high neutron flux (eg fast breeder reactors). If this method is to be realized at all, it can only be realized within the framework of a far more extensive nuclear energy programme than that which has been adopted in Sweden.

Accordingly, the research programme has been oriented towards the goal that final disposal of the spent nuclear fuel shall be achieved deep down in the Swedish bedrock. The KBS-3 report has described one method based on this principle. The method has been approved from the standpoint of safety and radiation protection.

The purpose of SKB's research and development is to provide a broad information base for the final choice of method. In principle, the work is not bound to any given method. It adopts a generic approach, studying matters that are of importance to many alternatives for

final disposal in rock. This means that a number of other methods are also being studied and evaluated in present and future research.

The following fundamental requirements have been discussed in recent years: a final repository should be designed so that it renders surveillance and maintenance unnecessary for safe function, but does not prevent intervention and corrective measures ("repairs") in the future, for example if future knowledge should show that the design of the final repository was unsuitable. "We should not place responsibility for the final repository on future generations, but nor should we deny future generations an opportunity to assume responsibility" /3-10/. SKB believes that this principle is correct. Both of these requirements are satisfied in a crystalline rock repository of, for example, the KBS-3 type. Repositories based on some other design principles do not always meet such requirements.

### 3.3 FACILITIES AND SYSTEMS IN OPERATION

#### 3.3.1 Final Repository for Reactor Waste, SFR

The final repository for reactor waste, SFR, is situated at the Forsmark Nuclear Power Station /3-4/. Operational waste from the Swedish nuclear power plants is being emplaced in SFR, along with similar waste from CLAB and Studsvik. This Studsvik waste also includes waste from the use of radioisotopes within research, industry and medicine.

The waste being deposited in SFR is low- and intermediate-level and short-lived, which means that it will have decayed to a harmless level within a few hundred years. Table 3-1 shows the quantities of wastes that are planned to be deposited in SFR.

Table 3-1. Waste to be deposited in SFR.

	Storage volume (m <sup>3</sup> )
Operational waste	
Intermediate-level	65 000
Low-level	<u>25 000</u>
	90 000
Decommissioning waste	
Intermediate-level	12 000
Low-level	<u>88 000</u>
	100 000

SFR is situated in rock with a rock cover of about 50 m. It consists of different excavated caverns, designed with reference to the activity content in the different kinds of waste, see Figure 3-2.

SFR is being built in two phases, the first of which was taken into service in 1988, while the second is planned to be commissioned at the end of the 1990s.

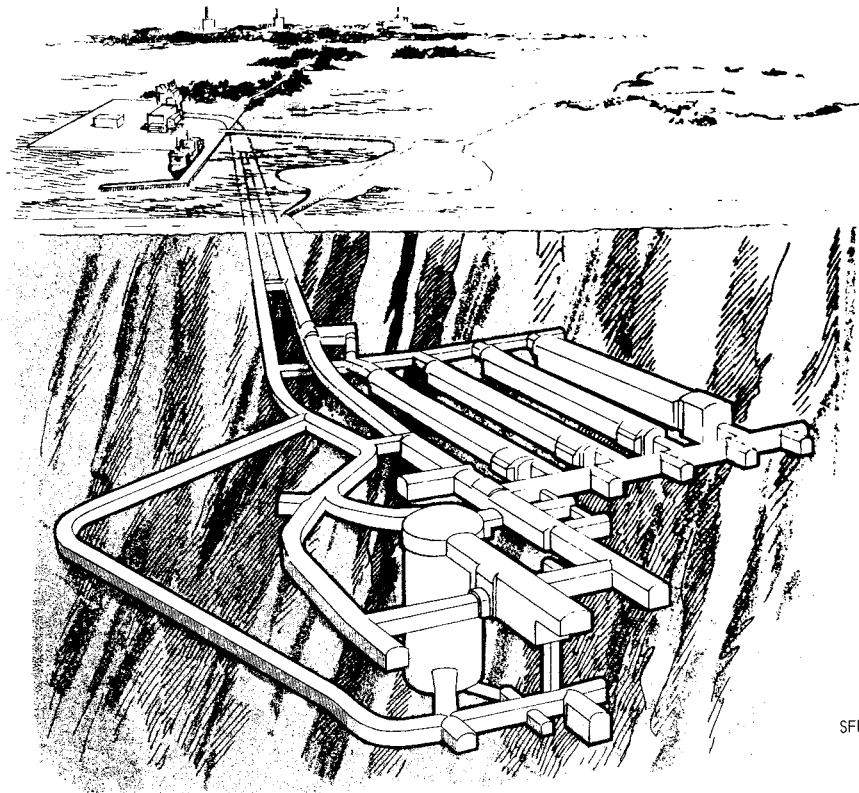

SFR1, FORSMARK

Figure 3-2. Final repository for reactor waste (SFR 1).

Rock vaults for the final disposal of decommissioning waste are also planned within SFR. These vaults will be built when the time comes to decommission the nuclear power plants. A new Government licence is required before that.

The application for a siting permit for SFR stated that the facility may later be expanded so that core components and reactor internals can also be deposited there. In the previously mentioned PLAN 89, it is assumed for practical reasons that this waste will instead be disposed of in the final repository for long-lived waste. However, the possibility of depositing it in SFR should be kept open.

### 3.3.2 Central Interim Storage Facility for Spent Nuclear Fuel, CLAB

The spent fuel will be stored for about 40 years in the central interim storage facility for spent nuclear fuel, CLAB, which is located adjacent to the Oskarshamn station. During this period, the fuel's activity content and residual heat will decline by about 90%. CLAB was taken into operation in 1985, thereby relieving the heavy demand on storage capacity for spent fuel at the nuclear power plants /3-5/.

CLAB consists of an above-ground receiving building and an underground storage complex in rock, see Figure 3-3. The fuel is handled and stored under water. The capacity of the facility is now about 3 000 tonnes of

spent fuel in four pools. By storing the fuel at higher density, the storage capacity of the existing pools can be increased to about 5 800 tonnes U. An application for permission to expand is currently being considered by the Government. An expansion is planned for the beginning of the 21st century so that all fuel from the Swedish nuclear power programme, about 8 000 tonnes, can be stored in CLAB. The facility is prepared for this and the expansion can be carried out at the same time as fuel is being brought in and stored in the pools in the existing rock cavern.

Core components and reactor internals can also be stored in CLAB.

### 3.3.3 The Transportation System

A transportation system based on sea transports is used for shipments of spent fuel and radioactive waste /3-6/. It consists of a ship, M/S Sigyn, transport containers and terminal equipment, see Figure 3-4. The transport containers meet the stringent requirements on radiation shielding and ability to withstand external stresses that have been issued by the International Atomic Energy Agency (IAEA). Different types of transport containers are used for spent fuel and for low- and intermediate-level waste.

M/S Sigyn has been in use since 1982. Since 1988, the ship has been transporting both fuel to CLAB and operational waste to SFR. If needed, the transportation

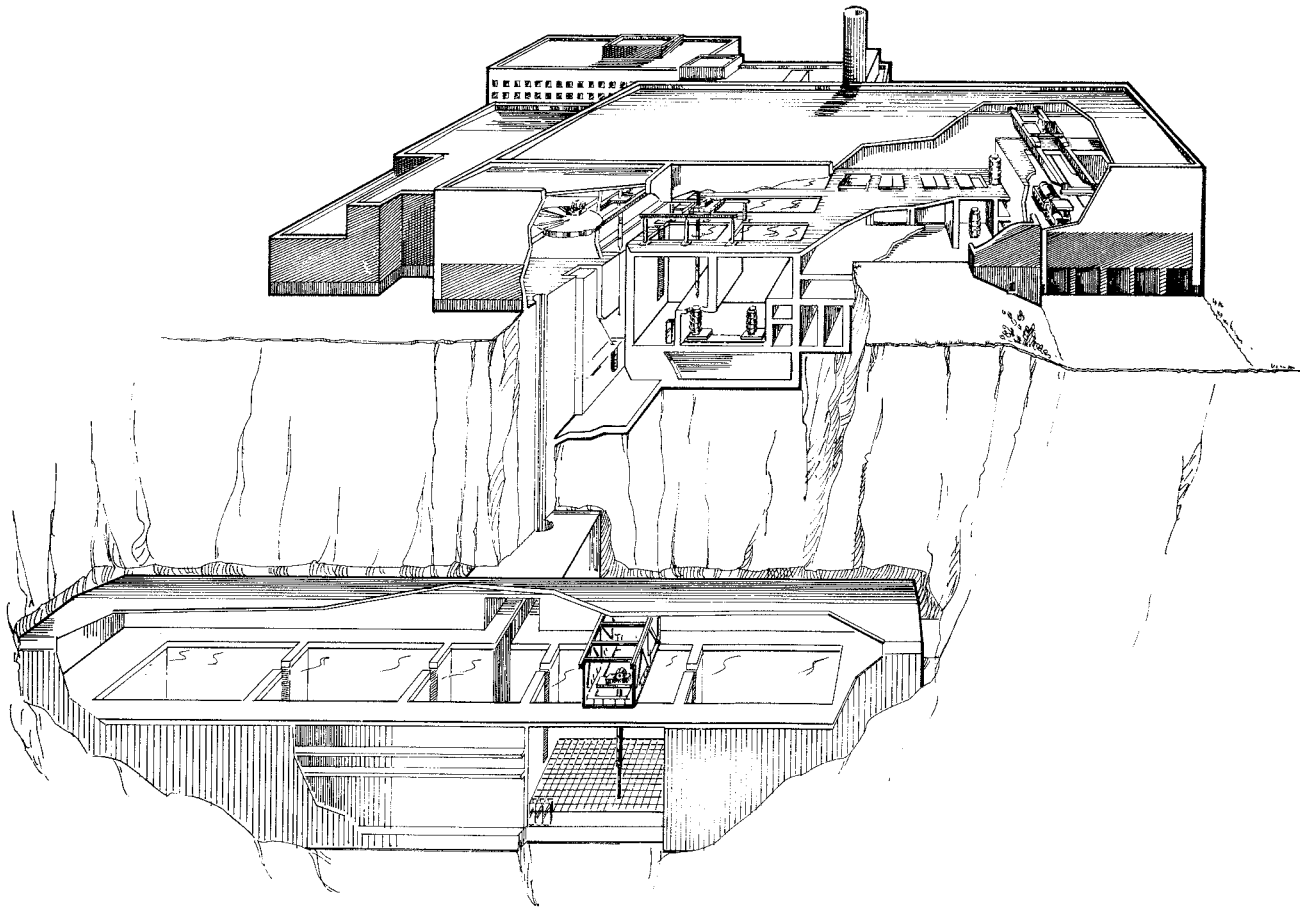

Figure 3-3. Central interim storage facility for spent nuclear fuel (CLAB).

system can later be augmented with equipment for eg rail shipments for the transports to the final repository for long-lived waste. The need will be dependent on where the final repository is sited.

### 3.4 FUTURE FACILITIES AND SYSTEMS

#### 3.4.1 Encapsulation Plant for Spent Fuel, BS

Before spent fuel is placed in the repository, it will be encapsulated in a canister that facilitates handling and provides a tight containment of the fuel for a given period of time. KBS-3 describes encapsulation of the fuel in a copper canister, which provides a total containment over a very long period of time /3-7/. Other materials may also be considered for the canister.

The design of the encapsulation plant is dependent on which encapsulation method will be used and the location of the facility. In PLAN 89, the plant has been assumed to be situated adjacent to the final repository for long-lived waste, in which case the canisters will be

taken down into the final repository immediately after encapsulation. Another alternative is that it will be situated at CLAB, in which case encapsulated fuel must be transported to the final repository.

The final choice of material and method for encapsulation entails a firm commitment to a specific final disposal method and should therefore not be made earlier than necessary. Encapsulation of the fuel is planned to take place immediately before its deposition in the final repository. It is therefore not necessary to begin construction of the encapsulation plant until around the year 2010, according to present planning.

#### 3.4.2 Final Repository for Long-lived Waste, SFL

The final repository for long-lived waste, SFL, is planned to be taken into service around the year 2020. It is intended to be situated deep in crystalline rock. The site has not yet been chosen. SFL will be used primarily for disposal of the spent fuel, but also other long-lived waste, above all from Studsvik. For practical reasons, some low- and intermediate-level waste from the operation and subsequent decommissioning of CLAB and the



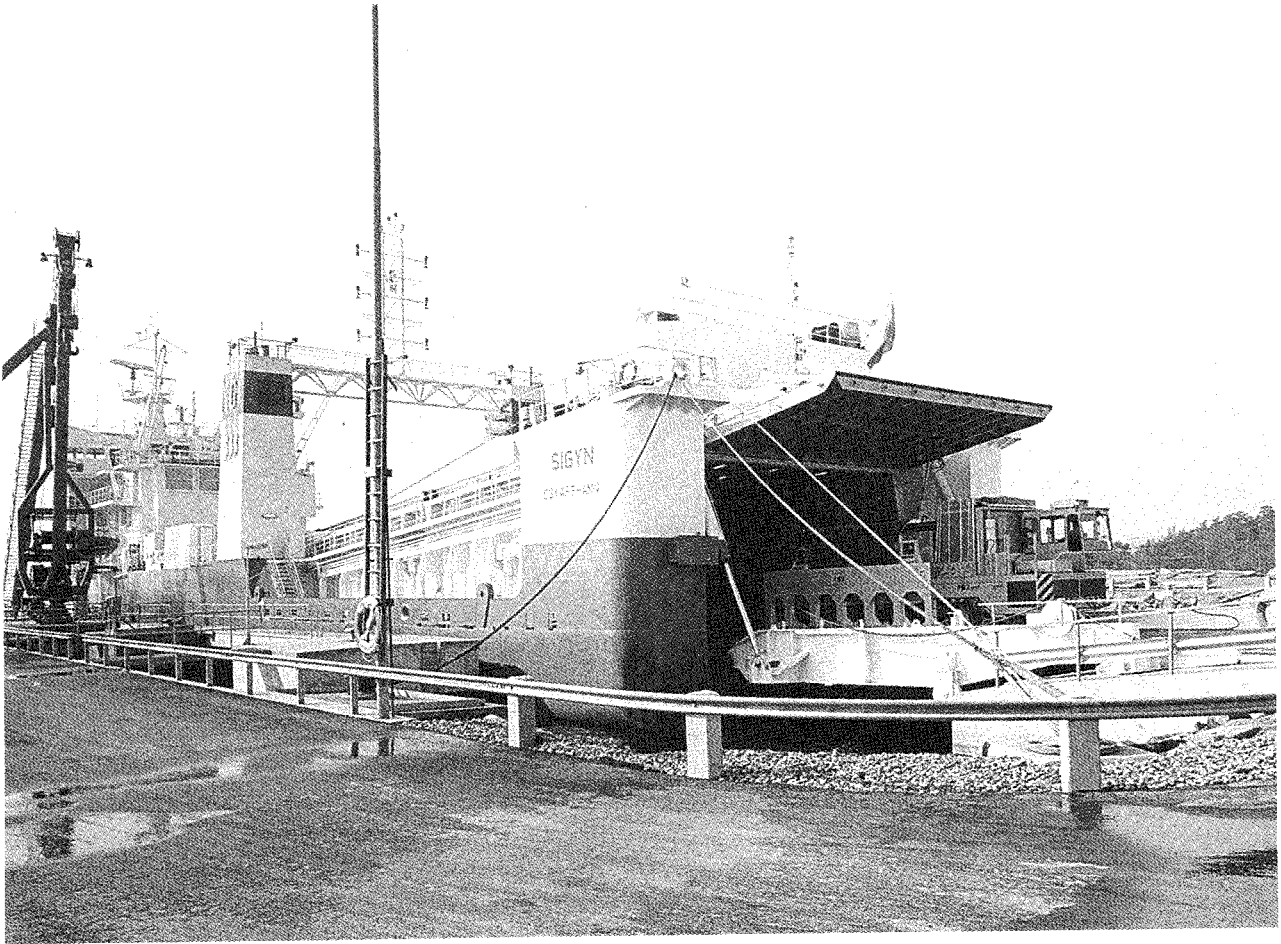

*Figure 3-4. Transport vehicle with transport cask leaving the cargo hold of M/S Sigyn.*

encapsulation plant is also being planned to be disposed of in connection with SFL.

A possible design of the final repository for spent fuel is described in KBS-3, see Figure 3-5. The method involves depositing copper canisters containing spent fuel in holes drilled in the floor of tunnels at a depth of about 500 m. In the boreholes, the canisters are embedded in compacted bentonite. When deposition in a tunnel is concluded, the tunnel is sealed with a sand/bentonite backfill.

Until a decision is taken concerning the location and design of the facility, alternative designs of the final repository will be studied, as described in Chapters 4 and 5 and in Part II.

The repository for other long-lived waste has not yet been studied in the same degree of detail as the repository for the spent fuel. One possible design, where the waste is emplaced in different kinds of rock vaults at a depth of about 500 m, is described in PLAN 89.

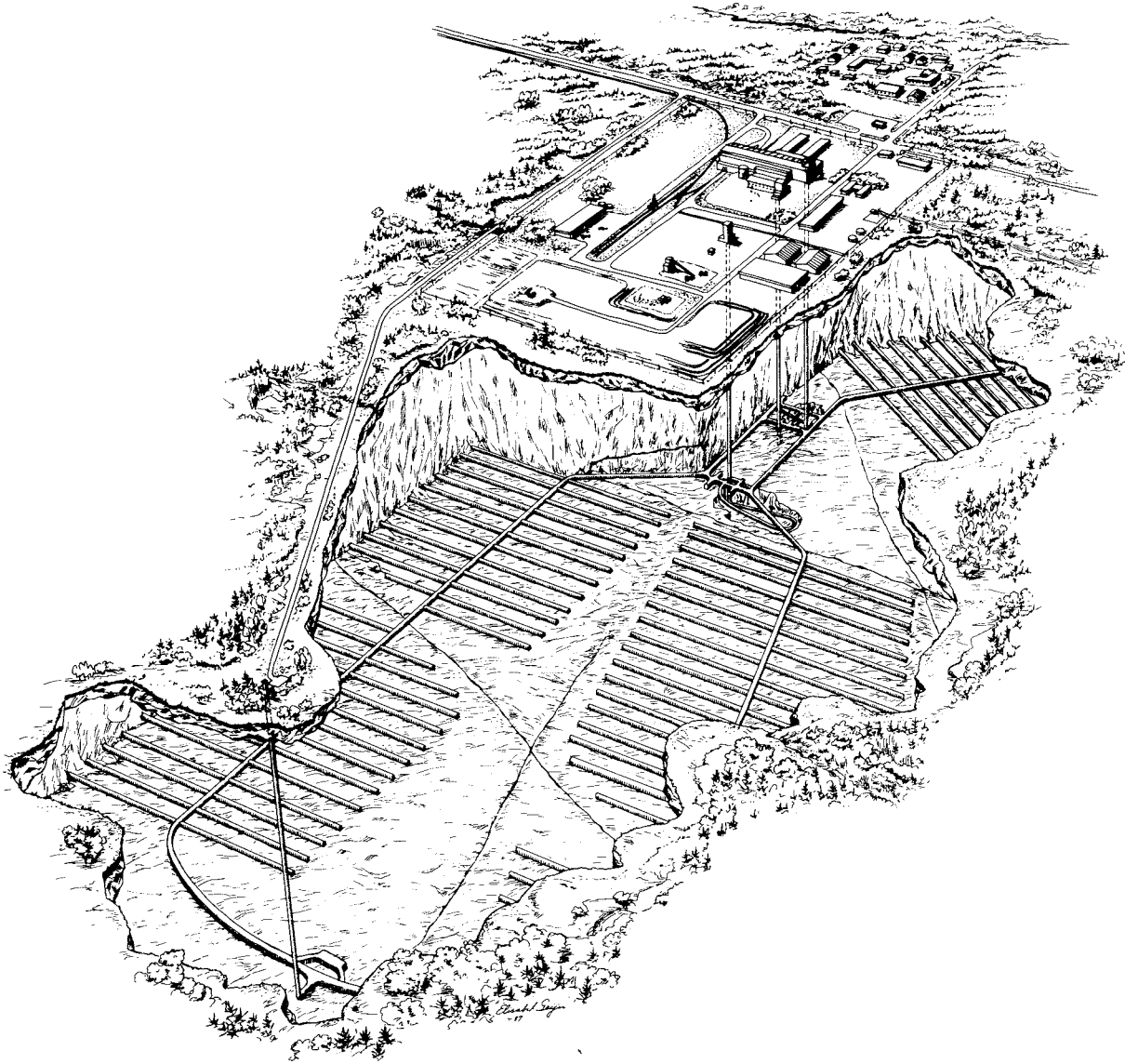

Figure 3-5. Overall layout of final repository for spent fuel – SFL.

### 3.5 TIMETABLE

An overall timetable for the measures that have to be adopted for handling and disposal of the radioactive waste from the Swedish nuclear power programme is shown in Figure 3-6. The timetable is based on practical considerations and serves as a basis for the planning of R&D-work and other measures. It is also used for

calculating the costs of disposal of the waste from nuclear power in Sweden /3-1/.

The timetable is not final and changes in one direction or the other may prove to be warranted. The consequences of changes in the main timetable have been analyzed in /3-8/. It shows that relatively large changes can be accepted without any safety-related consequences.

Thus, if desired, interim storage in CLAB can be continued for a longer period than 40 years. In practice, no commitment is made to the choice of final disposal system until encapsulation of the fuel has begun. It is there-

fore assumed that construction of BS will begin at roughly the same time as construction of SFL. Consequently, the start of construction will be a crucial time of decision.

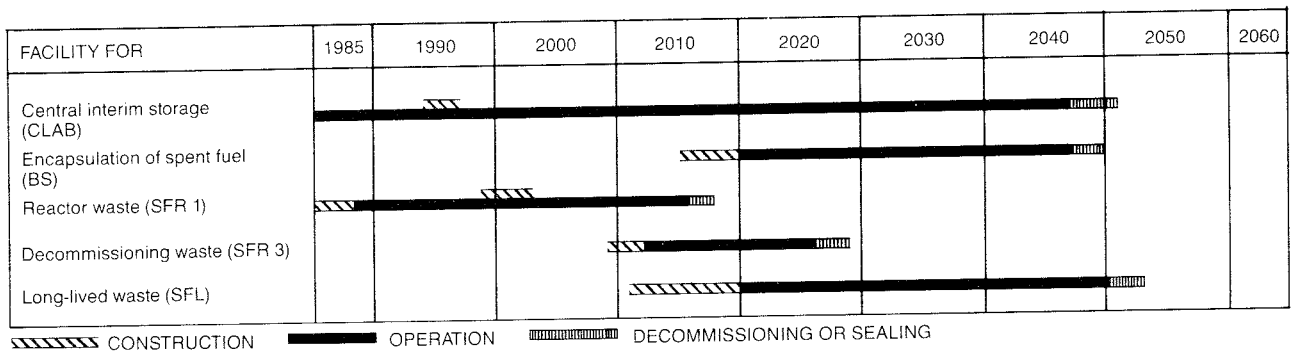

Figure 3-6. Overall timetable for facilities in the Swedish waste management system.

# 4 FINAL DISPOSAL OF SPENT NUCLEAR FUEL. OVERVIEW OF GOALS, PLAN FOR ACTIVITIES AND STATE OF KNOWLEDGE

## 4.1 GOALS OF THE RESEARCH WORK – GENERAL

General goals and guidelines for the management of the waste from the Swedish nuclear power plants are presented in Chapter 1. The research and development work shall be conducted in such a manner that the measures described in Chapter 3 can be carried out according to the stipulated timetable and in such a manner that the goals of waste management are achieved.

During the coming 10-year period, the work will be concentrated on assembling the necessary basis so that a site-specific siting application for a final repository for spent nuclear fuel can be submitted no later than the year 2003. Prior to that a system optimization is needed to adapt the system design to the selected site.

The research and development work will be conducted with due regard to:

- environment and safety,
- economy,
- comprehensiveness,
- flexibility,
- relevance,
- broad acceptance in society.

The requirement on comprehensiveness means that different alternative systems will be studied and evaluated. Flexibility should therefore be retained for as long as possible. Effective R&D requires well-defined goals and distinct frames, however. The most promising and realistic alternatives should therefore be given priority and the research must be related to those phenomena and questions that are of relevance to the safety and economy of the final repository.

Up to 1984, the goal of SKB's research was to demonstrate the feasibility of safe final disposal of spent nuclear fuel in Sweden. The work was concentrated on a specific method. This is described in the KBS-3 Report /4-1/. The safety account in KBS-3 is based on a number of pessimistically chosen premises and credit has not been taken for a number of favourable factors. The assessment has been carried out using methods and data chosen to define an upper limit for the impact of the repository on the biosphere. The account in KBS-3 therefore contains considerable safety margins that were not possible to quantify at the time.

One important goal of the ongoing and continued R&D-work is to gain better knowledge of the actual

safety margins. Improved knowledge in this respect provides a better basis for an optimization and an adaptation to local conditions, while at the same time allowing greater freedom in the siting of the final repository.

The different types of radioactive waste that are generated in the Swedish nuclear power programme are described in Chapter 2. Measures to manage and dispose of these waste types are described in Chapter 3. Most of the waste forms can be handled and disposed of in the same or a similar manner as the waste that is to be disposed in SFR.

Spent nuclear fuel and certain other waste types require a more qualified final disposal, however. The research is primarily aimed at refining this more qualified disposal.

The research is thus focussed mainly on final disposal of spent nuclear fuel in the Swedish bedrock.

## 4.2 SOME POINTS OF DEPARTURE FOR THE R&D-WORK

A final repository for spent nuclear fuel must meet society's demands on safety. These demands aim to protect human beings and nature against harmful effects caused by the waste now and in the future. The goal is that the long-term effects of the repository should not change the natural radiological conditions in the area in any essential way. During the construction and operating phases, the activities must be carried out in such a way that a good working environment is ensured and environmental impact is minimized.

The final repository is designed as a system of engineered and natural barriers intended to isolate the waste for such a long period of time that the radioactive materials decay to a harmless level. The barriers are both natural (geological) and engineered (waste matrix, canister, buffer). The research concerns the properties and performance of these barriers with the aim of arriving at an optimized choice of barrier system and repository site. A general account of the primary factors influencing the choice and design of a final repository system is provided in R&D-Programme 86 Part II Chapter 2 /4-2/.

Final disposal of spent nuclear fuel can be effected in a number of different ways. The method described in the KBS-3 report has been accepted by the Swedish Government and regulatory authorities as being acceptable with regard to safety and radiation protection. This

method is therefore a reference alternative for further studies of other interesting alternatives. Since the KBS-3 report was published, the research work has been study and obtain a deeper knowledge of different parts of the final repository system described in KBS-3 and in general of phenomena of importance for an understanding of final disposal in Swedish bedrock. The other has been to analyze and evaluate alternative designs of the final repository. This chapter presents an overall plan for the R&D-work and summarizes the present-day state of knowledge on the basis of the experience thus gained. Chapter 5 summarizes the planned research and development for the six-year period 1990–1995.

As already mentioned, the continued research work is aimed at assembling the necessary basis for a site-specific siting application by the year 2003. An overall plan to achieve this goal has been prepared and is described in the following section prior to the summary of the present-day state of knowledge. In connection with the account of the state of knowledge, the different stage goals that should be achieved in the different areas in order to fulfil the sub-goals of the main plan are described.

## **4.3 OVERALL PLAN FOR THE R&D-WORK**

### **4.3.1 R&D-Programme 86**

The overall research plan presented in R&D-Programme 86 briefly entailed the following. Up until the mid-1990s, goal-oriented research will be conducted on alternative designs of the barrier system and on the fundamental phenomena of importance for safety, optimization and choice of system and site. At the same time, the necessary development of analysis models will be pursued. In parallel with this, the general characterization of study sites that has been going on since the end of the 1970s will be completed. In the early 1990s, a couple of sites will be selected for detailed investigations. These investigations should not be begun later than 1993 for all the sites that could be candidates for a siting application in the year 2000. In the mid-1990s, the studies of barrier systems will be summarized and one or possibly two main alternatives will be chosen as a basis for a site-specific optimization of the final repository system. The optimization will be completed by 1998, when work will begin on a siting application for a specific site. Accordingly, this planning entails a final choice of system in the mid-1990s and of site in 1998.

In connection with the review of R&D-Programme 86, SKN expressed certain viewpoints on the site selection process in particular. SKN wanted a successive narrowing-down of the number of possible sites to take place through a screening procedure divided into three phases: test phase, selection phase and licensing phase. During the test phase, roughly speaking the 1980s, a

relatively large number of areas judged to be particularly suitable for the siting of a final repository would be screened out. Affected municipalities and county administrations would be notified and asked to set aside the specified identified areas in their general plans on landuse. Such plans are to be drawn up for all municipalities in the country prior to June 30, 1990. During the subsequent selection phase, in the 1990s, the field studies would continue and those sites that are best suited for a safe final repository would be selected. On the basis of proposals received from SKB and after circulation of these proposals for comment, SKN would then judge whether a “national interest” exists under the terms of the Natural Resources Act and would notify the concerned municipalities and county administrations that this is the case. The designation of a “national interest” means that the land areas in question must be set aside for a specific type of facility, in this case a final repository, and may not be utilized for any other purposes.

A Government resolution passed in December 1987 stated that R&D-Programme 86 meets the requirements of the Act on Nuclear Activities and should serve as a basis for the continued work, and that SKN's review viewpoints should be taken into account wherever possible.

The work since 1986 has by and large followed the plan laid down in R&D-Programme 86. However, experience gained since then has occasioned certain refinements of definitions and modifications of the plan.

### **4.3.2 Programme for R&D and Other Measures**

An overall timetable for the measures that have to be adopted for management and disposal of the radioactive waste products from the nuclear power programme is presented in Chapter 3 Figure 3-6. According to this timetable, the planned start of construction for the final repository for long-lived waste and the encapsulation plant for spent fuel is the year 2010. Figure 4-1 shows an overall timetable for the R&D, technology development and other measures that are required prior to the start of construction.

The fundamental research in certain key areas and concerning different alternative designs will continue until the mid-1990s with more or less the current scope.

The inventory of possible sites for the construction of a final repository that has been going on more or less continuously since the beginning of the 1980s will be concluded by 1991. In addition, certain geological survey studies will be carried out on the basis of currently existing geological data. These supplementary studies are of a general nature and do not require any further drilling or borehole measurements.

A new safety assessment called SKB 91 is planned to be finished in 1991. One of the purposes of this assessment is to evaluate further and more systematically than

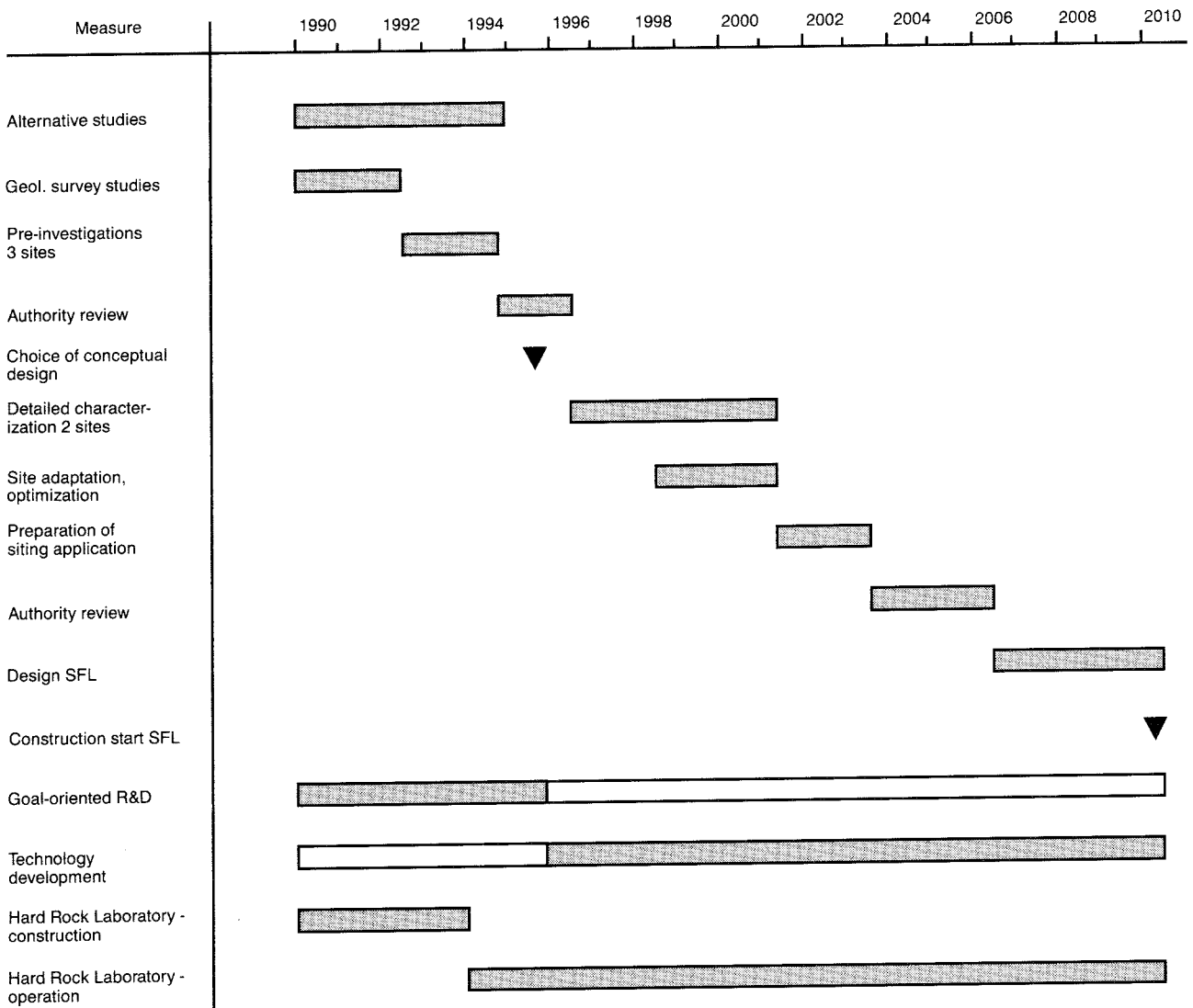

Figure 4-1. Overall timetable for design and siting of final repository for spent fuel (SFL).

before the importance of variations in the geological conditions for the performance and safety of the final repository. The KBS-3 report stated that "The analyses show that even sites such as Finnsjön, with higher groundwater flows than those mentioned (Gideå and Kamlunge, and probably also Fjällveden) could be acceptable from the safety viewpoint." In SKB 91 this will be further backed-up on the basis of the experience gained since 1983 when KBS-3 was written.

As far as the siting of the final repository is concerned, SKB does not believe it would be advisable to follow the procedure described by SKN in all respects. As was reported in R&D-Programme 86, the extensive material gathered in geological field investigations shows that there are many sites in Sweden that are suitable for the siting of a final repository from the geological point of view. This means that other factors can be accorded greater importance in the siting. It is

doubtful whether it is possible with reasonable efforts to identify the site that is best in all respects. Nor is it necessary; it is quite sufficient to find a site where the rock possesses such characteristics and where conditions otherwise are such that a very high standard of safety and radiation protection can be met. In SKB's view, there is no reason to demand a more detailed selection process than demonstrating with general data that there are no obviously more suitable areas available than those finally proposed. The important, technically detailed evaluation of whether a site is suitable and whether it is possible to build a final repository there that meets the very high standards of safety will be made in connection with the review of the siting application. This evaluation cannot be performed until site-specific data and a site-adapted design are available.

During 1992 SKB intends to announce three sites which SKB consider suitable as candidates for siting of

the final repository. The body of data on these three sites might at this time be of a general nature and must then be augmented through preliminary characterization. However, the purpose is to be able to concentrate subsequent geologic surveys, licensing questions and information activities to a few (minimum number) promising areas. As a basis for the selection of candidate sites, the results of the aforementioned studies will be presented simultaneously, along with a summary of existing data on the three sites. In connection with the announcement, SKB's information on matters of special interest for the siting of a final repository will be intensified.

After permission has been obtained from the landowner, pre-investigations will be carried out during the years 1992–1994. At the same time, SKB 91 will be supplemented to provide a basis for an initial preliminary evaluation of the long-term safety of a final repository located at each of the three sites. During 1994, a general programme for subsequent detailed characterization of the candidate sites will be drawn up.

Investigation results, programme for detailed characterization, preliminary safety assessment and environmental impact statements for the detailed characterization will be submitted to the concerned authorities at the end of 1994. The concerned authorities are primarily SKN, the municipality and the county administration. SKI, SSI and other agencies can be expected to serve as reviewing bodies for the aforementioned authorities. After a review period of about 18 months, it is estimated that the necessary approvals and permits for detailed characterization may be available in early 1996. Such investigations will then start on one site, and on a second site in 1997. The detailed characterization will be carried out in appropriate stages.

As a basis for starting detailed characterization, a rough layout of the area needed for a final repository is required. A conceptual design of the final repository system must therefore be selected during 1995. In connection with this, a summary of completed studies of different alternatives and of then-existing knowledge concerning the components in the barrier system will be submitted. It is assumed that this can be done in connection with R&D-Programme 95. During the years 1995–98, the necessary supplementary studies for the components in the selected fundamental design will be carried out, and the models required for an optimization of the final repository to the site that is finally selected will be verified. The optimization will be carried out in parallel with a second stage of the detailed characterization.

These activities are expected to be finished by 2001, when work will begin on preparing a siting application under the Natural Resources Act and under the Act on Nuclear Activities. The application, which should preferably be completed by 2003, contains a preliminary safety report with a detailed assessment of the long-term safety of the final repository. It is assumed that the application will take three years to process, which would

mean that a site approved by the Government will exist by 2006.

After the site has been approved, engineering drawings for the final repository and associated facilities will be prepared and the safety report updated, especially with respect to safety during the operating (deposition, surveillance) phase. This report is expected to be finished in 2008 and will comprise the basis for SKI's and other authorities' approval of start of construction in 2010.

SKB's goal throughout the siting phase is that experience from the R&D-activities shall be exploited in a systematic fashion and that the safety-related importance of the resultant information shall be successively evaluated. On the basis of this evaluation, critical parameters and conditions will also be identified as a basis for R&D-prioritization.

#### **4.4 STATE OF KNOWLEDGE REGARDING SAFETY ASSESSMENTS**

The handling and final disposal of the radioactive waste must be carried out in an acceptable fashion with respect to safety and radiation protection. The safety of the activities is assessed by means of performance and safety evaluations. The performance analysis constitute studies of subsystems and their interaction, or of the special conditions under which performance is to be guaranteed. The performance studies then serve as a basis for the analysis of total safety that make up the safety assessment. Besides safety level, a safety assessment shall also define the uncertainty with which the judgements are associated and attempt to quantify the safety margins as far as is possible.

The purpose of the performance assessment will change during different phases of the development and licensing of a final repository. In the introductory phase, the performance of the subsystems in the repository will be evaluated. The uncertainty existing in current knowledge regarding essential functions will indicate priorities for research and development.

In a later phase, an attempt will be made to find a balance between the safety barriers, ie the system will be optimized with respect to performance and cost at an acceptable safety level. During the licensing phase, it must be formally and finally demonstrated that the system fulfils the demands made by society on safety.

Performance assessments include the following main elements:

- review of the external circumstances (scenarios) that can arise and definition of which of these scenarios the repository shall be able to cope with,
- description of the processes of importance for the safety of the repository that can occur, and of the models and databases with whose help the processes can be quantified,

- estimates of the performance of the repository at different relevant points in time for the design-basis scenarios.

A safety assessment must also include the following elements:

- definition of applied acceptance requirements/criteria for the repository and over the relevant time spans,
- comparisons between estimated consequences/probabilities and the acceptance criteria,
- analysis of uncertainties in the data and models with respect to their importance for safety.

The degree of detail and completeness in the elements will vary with the state of development and the knowledge base, as well as with the specific purpose of each assessment.

#### 4.4.1 Goals of the Work with Safety Assessments

The overall goals of the work of developing methods for safety assessments are:

- to carry out the safety assessments that are required in different phases to obtain licenses and gain acceptance of the final repository for reactor waste from the Swedish nuclear power plants,
- to be able to carry out more realistic assessments so as to better quantify the safety margins.

The stage-specific goals for the safety assessments are closely linked to the overall plan presented in section 4.3 above. Important stage goals are:

- a complete safety assessment “SKB 91” will be carried out by 1991 for a design closely related to KBS-3. The assessment will be carried out in such a manner that variation analyses can easily be performed,
- coupled to the safety assessment, variation analyses will also be performed by 1991 of how different geological conditions influence the results of the safety assessment,
- site-specific assessments, complementary to SKB 91 will be carried out by 1994 for the candidate sites identified in 1992,
- comparative performance evaluations will be carried out by 1995 for those barrier alternatives that can be of importance for the execution of detailed geological characterization,
- performance and safety assessments will be carried out by 2001 as a basis for optimization and site adaptation of the selected final repository system,
- a safety assessment will be carried out by 2003 of the long-term performance of the repository as a basis for a siting application.

Methodological development for uncertainty studies, scenario definition, validation etc, and for presentation of results, is intended to be pursued continuously in close international cooperation and coupled to the specific requirements made by the assessments in various phases of the R&D-programme.

- A systematic review of the scenarios that should be included in a safety assessment, based in large part on the work with SKB 91, will be supplemented and reported in R&D-Programme 92.
- During the coming three-year period, QA guidelines are intended to be specified for, among other things, documentation, handling and storage of data, as well as for programming and documentation of computer programs.

#### 4.4.2 State of Development for Safety Assessments

At an early stage, repository performance assessment was divided into scenario analysis and consequence analysis.

The scenario analysis includes an identification of possible scenarios as well as a description of how different scenarios affect repository performance and the probability that they will occur. The requirement that no relevant scenarios are to be neglected entails high demands on the ability of the methodology to identify possible events and processes in a logical manner. The first part of the work, identification of scenarios relevant to safety, has often been done in a relatively unstructured manner.

Since many aspects of scenarios are global, in other words independent of site and repository design, SKB has deemed it essential that the development work within this area be carried out in close international cooperation. In order to create a consensus on how scenarios are identified, SKB has, together with SKI, worked actively during 1986/87 to initiate cooperation in scenario work within OECD/NEA. Since 1987, a working group within NEA’s committee for radioactive waste management has dealt with these questions. Methods used by different groups in the world have been collected and systematized. The purpose is to create an international overview of available methods and discuss their advantages and disadvantages in a state-of-the-art report. A preliminary document is expected to be ready in 1990.

A consequence analysis in a broad sense includes studies, analyses and calculations of the performance of the repository within the different scenarios.

Quantified forecasts of repository performance require that the processes that are important for safety can be modelled. Calculation models for source strength, temperature effects, groundwater flow, canister penetration, release of radionuclides in the fuel, nuclide transport in the near field, groundwater path-



ways in the rock, groundwater transport of radionuclides, interaction of radionuclides with fracture faces and rock matrix, paths of discharge to the biosphere and radionuclide dispersal in the biosphere, as well as resulting doses to man, must be applied in sequence.

The present-day state of knowledge with regard to most interesting processes concerned with engineered barriers or the rock is described in brief in the following section and in greater detail in Part II.

In view of the uncertainty existing in the forecasts of future waste quantities, present-day calculations of the quantity of radionuclides in the spent fuel should be able to be performed with sufficient accuracy using existing calculation models.

A major problem in the safety assessment is to be able to evaluate how uncertainties in input data translate into uncertainties in calculated consequences. A computer programme package called PROPER has been developed within SKB for this purpose. The core of the PROPER package is the monitor that is used to link a number of submodels, taken from a library during the run, into a total model for the problem at hand, and to propagate the uncertainties in the input data through the sequence of submodels. The monitor is now available in a tested version 1.0, which will be utilized for SKB 91.

Data from SKB's field investigations is now being collected in a database called GEOTAB on an in-house computer. All important data from previous years' investigations are stored in this database. Routines for QA have been established and are regularly revised.

In 1989, SKB acquired its own computer, CONVEX 210, with very high performance. This means that all heavy computations for safety and performance assessment can be run on the same computer. It also enables more comprehensive simulations to be carried out than have previously been possible within a given cost frame. Integration of the computer programs also permits good quality assurance of the data processing and the computations.

## **4.5 STATE OF KNOWLEDGE REGARDING ENGINEERED BARRIERS**

As is evident from Chapter 3, the purpose of the ongoing research work is to establish a method for final disposal of the long-lived waste deep down in the Swedish bedrock. A large number of different designs and combinations of engineered barriers are possible within the framework of this main line. A systematic review of possible alternatives was provided in a background report to R&D-Programme 86. The present-day state of knowledge regarding the choice of barrier system is summarized in the following. A more detailed account is given in Part II.

### **4.5.1 Goals of the Research Regarding Engineered Barriers**

The research and development work regarding the engineered barriers is being conducted with the aim of achieving the following goals, which are linked to the overall programme for the work described in Section 4.3.2:

- A conceptual main design shall be chosen before the detailed characterization of two alternative siting areas are begun.
- Material, temperature level and other relevant parameters for the canister and buffer material shall be determined at the same time as a conceptual main design is chosen. This means that applicable limits for these essential parameters and for the materials that can be of interest must be established by then.
- The properties and characteristics of the spent fuel in a repository environment shall be clarified sufficiently so that they can be taken into account in the choice of material, temperature level etc. This means that a validated model for fuel corrosion in the repository environment should be ready by 1995.
- The studies of how the engineered barrier alternatives in the near field can be designed and of possibilities for chemical conditioning shall be completed by 1998. This means that data, models and general understanding of the performance of the engineered barriers in the chosen conceptual design shall be developed to a level that permits site adaptation and optimization of the final repository.

### **4.5.2 Design of the Final Repository**

The means used to isolate the waste from the biosphere are choice of location in the rock, encapsulation and measures to give the canisters a suitable environment in the rock. A good design shall permit the adaptation of available technology for construction of the engineered barriers to the isolating characteristics of the rock.

In recent years, two fundamentally different final repository alternatives (in comparison with KBS-3) have been studied: WP-Cave and very deep boreholes. The alternatives are described in brief in Part II of this programme. A comparison between WP-Cave and KBS-3 has been completed. The results show that:

- both concepts can provide acceptable safety,
- utilization of the potential of WP-Cave requires considerable development efforts in areas where understanding and data are incomplete today,
- the higher temperatures reached in WP-Cave entail, via uncertainties in data and dominant processes, a higher uncertainty in the calculated consequences,

- both repositories can be constructed with normal adaptation of currently existing technology,
- it cannot be said today whether it is easier to find a suitable site for one or the other design,
- the construction of a WP-Cave repository for Swedish needs would be much more expensive than a KBS-3 repository.

The conclusion is that the studies of WP-Cave as a complete system will not be continued.

The possibilities of disposing of waste in holes several kilometres deep have been studied on the basis of the information obtained from the drilling of very deep holes, such as the Siljan borehole. Preliminary results indicate favourable economics, but sufficient data do not yet exist to permit a clear comparative evaluation of this alternative. The studies continue.

### 4.5.3 Waste Forms

Since Sweden will not reprocess the spent nuclear fuel, the spent fuel is the waste form that will be disposed of. Direct disposal of spent nuclear fuel has been studied since the end of the 1970s in Sweden, Canada, the USA and the Federal Republic of Germany. Compared with high-level waste from reprocessing, the body of experimental data available on fuel as waste is limited. A total of only 30 or so scientific reports on the durability of the fuel in water have been published.

Many variables influence this durability, for example irradiation history, groundwater chemistry, redox conditions and temperature. Despite limited data, however, certain aspects of the dissolution mechanisms are relatively well known. It is possible today to describe the influence of the dominating variables on the kinetics for the dissolution of fuel. This represents a considerable improvement over the simplified and conservative model that was used in the KBS-3 work. The results of the research of recent years indicate that the dissolution time for spent fuel is a couple of orders of magnitude longer than was assumed in the KBS-3 safety assessment. The mechanisms of the dissolution are, however, not fully understood as yet.

### 4.5.4 Canister

In all programmes for final disposal of high-level waste, it is assumed that the waste is encapsulated in an impervious container prior to deposition. In most countries, the aim is an absolutely impervious containment with a canister life of at least 1 000 years. Sweden and a few other countries have in addition striven for impervious containment over a much longer time span, if possible tens of thousands or hundreds of thousands of years. The life of the canister is dependent on such factors as material, manufacturing method, design and repository environment.

The foreign research programmes that aim at a repository environment/geology that is most relevant for Swedish conditions are primarily those in Canada, Finland, Switzerland and the EEC.

Canada has chosen titanium as a reference material and copper as an alternative. In both cases, the aim is a thin-walled canister with a life of about 1 000 years.

Switzerland has chosen a thick-walled steel canister with a life of at least 1 000 years as the main alternative. The secondary alternative is copper.

The Finnish programme is very similar to the Swedish with a thick-walled, long-lived copper canister as the reference alternative.

The research work on copper canisters has, in recent years, concerned pitting corrosion, material creep, studies of welding technology for thick materials and some testing of material from hot isostatic pressing (HIP). Results obtained to date give no reason to revise the conclusions in the KBS-3 report that the most probable value of the pitting factor is five. An evaluation of the corrosion of a bronze cannon (96.3% copper) from the warship Kronan has been carried out. The cannon was buried in the sediment on the bottom of the Baltic Sea for 300 years. The results correspond to a corrosion of less than 10 mm over a period of 100 000 years.

Completed studies reveal considerable differences in creep properties of copper between the weld, the heat-affected zone and the parent metal. In addition, preliminary results show that the creep ductility of copper is relatively low. Further research is therefore required in this area. Development of welding technology has been pursued for a couple of years within a EUREKA project.

A couple of years ago, the highly surprising result was reported that copper could corrode with the evolution of hydrogen. The report was based on an experiment conducted at KTH (the Royal Institute of Technology) in Stockholm. Two independent groups have conducted verification experiments and have not been able to detect any hydrogen evolution, despite a much higher measurement sensitivity than should be required according to the KTH experiment. No scientific explanation of the reported observations has been forthcoming. In view of the results of the verification experiments and the existing, scientifically well-founded body of data on the thermodynamics of copper, SKB finds that the report on copper corrosion with hydrogen evolution can be disregarded.

For steel as a canister material, the work has focussed on studies of pitting. The results show that a canister life of about 1 000 years is possible with a wall thickness of 100 mm. The Swiss programme is primarily studying stress corrosion cracking and hydrogen-generating corrosion.

Titanium and titanium alloys exhibit very low general corrosion, particularly in chloride-containing water, which may be present on certain sites. The Canadian studies, however, have demonstrated some sensitivity for crevice corrosion. The research is therefore being

focussed particularly on this phenomenon. In Sweden, long-term exposures of up to six years of titanium in contact with bentonite have been concluded and the results reported.

Ceramics as canister materials have previously attracted considerable interest. Considerable work was done within the framework of the KBS project. After that work has been financed in Sweden by SKN and its predecessor. The problem with ceramics is first the manufacturing technology for full-sized canisters and second the risk of delayed fracturing. This phenomenon is not merely a material property, but is also linked to the manufacturing technology. Furthermore, it has been statistically demonstrated that the scaling-up of small-scale experiments can in some respects be misleading. Further work on ceramic canisters is therefore currently judged not to be of interest for Swedish conditions.

#### 4.5.5 Buffer and Backfill Material

Buffer material in the deposition chambers and backfill material in rock caverns, tunnels and shafts are examples of engineered barriers included in the final repository system. The primary function of these barriers is to limit groundwater flow. Buffer material shall also constitute a suitable chemical and mechanical protective zone for canisters in the rock. Sealing measures can take the form of plugs in excavated areas and sealing of the rock's fracture systems by means of injection grouting.

The isolating properties that characterize the transport conditions in the buffer material are low hydraulic conductivity and low diffusivity. Hydraulic conductivity is determined primarily by the density of the material and its content of the mineral smectite. A selection of well-defined clays has been compared with the reference clay in KBS-3, Mx 80. The comparison shows that with no reduction in density, hydraulic conductivity is low even if the smectite content decreases. The smectite content of the buffer material can decrease as a result of transformation of smectite to illite at a rate dependent on the temperature. A greater understanding of the relationship between microstructure and temperature, obtained through studies of clays in hydrothermal tests, has led to a more refined model for temperature effects. The model has been tested in the study of natural bentonites. A very important contribution has been the Gotland bentonite located at a depth of about 500 m at Hamra. The conclusion is that temperatures of 105-120°C are possible in deposition holes in compact bentonite without mineral changes being of importance for barrier function.

An inventory of Swedish buffer material candidates has been carried out and has not revealed any major Swedish deposits for buffer material in deposition holes, but it has found material for backfill.

The buffer material is supposed to interact with the rock and the canister to provide a suitable environment

for the canister. Thus, the canister is supposed to be borne up by the material in the deposition hole and protected from unfavourable loads or possible movements deriving from the rock. Several research projects are being conducted for the purpose of verifying the properties of the buffer material in this respect and developing validated models.

Bentonite can be deformed and change its volume through redistribution, absorption or emission of water. The water in highly compacted bentonite comprises approximately one-fourth of the volume, and the physical state of the bentonite varies depending on the clay mineral and the microstructure. The variation in density has been measured over a long period of time and discussed, also measurements using several indirect methods have been used. Examples are NMR (nuclear magnetic resonance), which has been tried for many years in an attempt to reveal the nature of the interaction between the clay mineral and the water.

A model for the physical state of water in different parts of the microstructure is of importance to obtain a theory for the rheology that can be applied in the formulation of the material model and in order to be able to extrapolate conditions over a very long period of time, for example for creep.

Rheological properties of bentonites have been measured. The subsidence of a simulated canister in a deposition hole was observed in the laboratory during the period April 85 – Dec 86, and observations are being conducted in Stripa, in both cases with temperature variations.

Shear tests with models simulating canisters in deposition holes have been carried out.

Mathematical models have been used for comparisons. They show that it is possible to model rate and temperature dependence in more or less dynamic processes such as thermomechanically or tectonically induced shear deformations or subsidences of canisters.

Attempts to reduce the water flow in the near field of the waste outside the buffer include backfilling with impervious materials in rock chambers and sealing of fractures in surrounding rock. The lower part of the disposal tunnels can be backfilled using currently known methods and equipment. Experience from Stripa, where backfill with 10-20% bentonite mixed with ballast material has been used, has shown that a compacting method and equipment for the upper part of the disposal tunnels can be developed. The test showed that water absorption took place with low water pressures in the near field in the surrounding rock despite relatively high pressures further out in the rock. The backfill filled out the tunnel completely, but the degree of compaction can be increased with a refined method for the application of fill in the upper part of the tunnel. Plugging of shafts, boreholes and tunnels was also tested. Experience from these tests has led to experiments with the sealing of rock fractures in a third phase at Stripa. The rock surrounding a drift is planned to be sealed in stages so that its hydraulic conductivity is reduced in a

measurable fashion. Of particular interest is to obtain data on the disturbed zone surrounding the tunnel. Sealing measures in the rock surrounding deposition holes are being tested, as well as sealing in a natural fracture zone.

The measures being tested at Stripa are examples of sealing measures intended to be included in a strategy that redirects the flow of water away from the near field of the waste. It presumes knowledge of the pattern of more conductive zones that communicate with the near field and the size of more impervious rock volumes in between.

The research includes laboratory tests and analysis of the long-term stabilities of the sealing materials based on cement and bentonite.

## **4.6 STATE OF KNOWLEDGE WITHIN THE GEOSCIENTIFIC FIELD**

The investigations during the 1980s have included field studies of a number of study sites, special studies of certain important questions, experiments and investigations at Stripa, development of measuring methods and instruments, planning for an underground research laboratory and development of models for groundwater flow in rock. On the eve of the 1990s, the geoscientific studies are being concentrated on a smaller number of subjects in the field than during the 1980s, but these subjects will be studied in deeper detail. Of central importance to the continued studies will be the planned underground research laboratory – also called the Hard Rock Laboratory – HRL.

### **4.6.1 Goals of the Geoscientific Studies**

The purposes of the geoscientific studies within the research programme are to:

- identify, quantify and/or set limits on the factors that can be of importance for the long-term safety of the repository,
- refine methods for obtaining geodata of importance for the safety and design of the repository.

Important subjects within the geoscientific field as regards safe disposal of nuclear waste are:

- groundwater movements and groundwater flow,
- groundwater chemistry,
- stability of the rock.

The geoscientific research is mainly concerned with these subjects. Groundwater chemistry is discussed under the section on chemistry.

The geoscientific studies shall be conducted during the 1990s with the following stage-specific goals:

- The work to develop a deeper understanding of groundwater flow in fractured rock will continue. The goal is to have calculation models available for optimization and site adaptation of the final repository by no later than 1998.
- The research work within the Stripa project will be completed and concluded in 1991. Within the frame of the project, a limited rock volume will be characterized on a 100 m scale. Models for groundwater flow and transport of tracers will be validated against measurement data from the characterized volume.
- Construction of the underground Hard Rock Laboratory will be commenced in 1990 and will have reached a depth of about 500 m by 1993. In connection with the construction of the Hard Rock Laboratory, methodology for pre-investigations and detailed characterization of candidate sites for repositories will be verified. The pre-investigation methodology to be used on the candidate sites will be described by 1991. The methodology for detailed characterization of candidate sites will be described prior to 1995. Data will be collected continuously to develop and validate models for groundwater flow with a view towards the goal specified above.
- Questions related to the stability of the rock shall be studied, preferably in connection with the site for the underground Hard Rock Laboratory and the candidate sites for the final repository so that zones of movement can be avoided when laying out the repository.

### **4.6.2 Groundwater Movements in the Rock**

The central, and at the same time the most difficult, problem in the assessment of the final repository's long-term safety is the flow of groundwater in the rock's fracture systems and the associated transport of substances dissolved in the groundwater. Great efforts have been made and are being made to shed light on this problem. Important, but by no means exhaustive, examples are:

- Extensive measurements of the hydraulic conductivity of the rock have been carried out in deep boreholes on all study sites.
- Tracer tests with non-sorbing tracers have been carried out at Studsvik, Finnsjön, Stripa and Hylte.
- Mapping of water-bearing fracture zones has been done through radar measurements and other geophysical investigations at Stripa and on several study sites.
- Tracer tests with sorbing tracers have been carried out in laboratories and in situ in Studsvik, Stripa and Finnsjön.
- Natural analogues, which can provide a picture of the behaviour of natural radioactive and chemical-related substances on a geological time scale, are

being studied at Poços de Caldas, Cigar Lake and in other projects.

In parallel with these experimental investigations, extensive efforts are being made to develop descriptive and mathematical models for systematizing and interpreting the data and results yielded by the field and laboratory tests.

It is important to give an account of how descriptive models of the site can be developed and validated with the data available in different investigation stages. Models can be based on different premises and can be applied on different scales. Experiments on different scales are therefore required for validation of the models.

Only a few facilities in rock exist today where the entire chain investigations – calculations – evaluation of groundwater flow has been carried out and documented.

Observations and data on the rock and on groundwater movements in the rock need to be processed and analyzed from different aspects. The most important are evaluation with regard to:

- available rock volumes of a given quality,
- existence of flow paths/zones,
- basis for layout of the repository on different scales,
- assessing the groundwater flow on different scales,
- assessing the flow paths of the water in the repository area and its environs.

Surface investigations provide the basis for an initial geological interpretation of a site. It is advantageous if surface investigations are carried out with different methods in parallel and if the investigations compared to successively evaluated in stages. It is difficult today – owing to limited documentation – to evaluate in general what surface investigations give compared to investigations in boreholes. It is essential that all material – geological, geophysical, geohydrological and geochemical – be interpreted together in stages. Particular attention must be given to the difficulty of clarifying the extent of subhorizontal structures. Surface descriptions provide the basis for the setting-out of boreholes and thereby also for interpretation of the data that are later obtained from borehole measurements.

Measurements in boreholes are based on sophisticated methods and are resource-demanding. In order to permit later evaluation, a number of independent methods must be utilized. It is difficult today to determine the specific usefulness of an individual method. However, borehole measurements and surface investigations together furnish sufficient information to make a preliminary evaluation of the performance of the repository and its geometric layout and to identify suitable rock volumes for detailed characterization.

Data from tunnels are already being utilized for the evaluation of repository performance and safety. The data collection technology needs to be developed so

that the information on, for example, pressure responses obtained during construction can be optimally utilized in the description of the site. Whether the data obtained during tunnel mapping etc are really relevant to the groundwater's distribution under natural conditions requires further elucidation.

The conceptual models available today can describe water flow and flow distribution with sufficient accuracy for designing a final repository or evaluating the life of waste canisters, provided that data on the host rock is obtained. In the safety assessment of a final repository, it is necessary to calculate how radionuclides are transported with the groundwater. It is not possible to do this with the desired accuracy today. It is not possible to specify which model or combination of models best represents reality. One is therefore forced in the assessment to use pessimistic models that greatly exaggerate this transport. More realistic and validated models will provide more certain knowledge of the safety margins and a better basis for the optimization of the repository and adaptation of it to the site.

The conceptual models that are available can be calibrated against experiments, but they are not discriminating in terms of how the physical flow takes place in the rock. Tracer tests with non-sorbing and weakly sorbing tracers are one possible way to distinguish the conceptual models. It has not yet been demonstrated that tracer tests provide a means of discriminating between different conceptual models. In recent years' safety assessments, SKB has used the channelling model for calculation of nuclide transport, since it provides the most conservative description of how the rock functions as a barrier.

### 4.6.3 Stability of the Rock

It is important to understand to what extent tectonic or climatic processes affect the performance of the repository. A low groundwater flow, a favourable chemical environment and the absence of rock movements that can damage the waste are guiding principles for the layout of the repository.

The studies that have been conducted support the notion that plate tectonics, together with ongoing land uplift, is of decisive importance for interpreting present-day and future movements in the bedrock. It is also evident that such movements take place preferably or exclusively along major fracture zones of very great age.

As a basis for design and assessment of the performance of the repository, it is also of importance to describe the extent to which a final repository can be affected by future ice ages. The study of tectonic and climatic factors is wide-ranging and in a state of rapid development. Large national and international projects are underway and are constantly improving our picture of the tectonic processes and their effects on the bedrock.

SKB has conducted studies of postglacial movements at Lansjärv. Among the conclusions are the following:

- the postglacial movements at Lansjärv are assumed for the most part to have been triggered by reactivation of preexisting fractures and faults,
- the orientation of older zones of weakness in northern Fennoscandia favour the occurrence of postglacial faults in the form of thrust faults and reverse faults,
- reactivation of the postglacial fault at Lansjärv has taken place through tectonic movements that may have been set off in connection with the deglaciation,
- the hydraulic conductivity in the cored hole at Lansjärv does not deviate significantly from the conditions measured in a large number of other boreholes in Swedish bedrock,
- zones of movement of the thickness studied can be avoided in the layout of the final repository. Despite the very dramatic course of events when the postglacial fault was formed at Lansjärv, the hydraulic conductivity and geochemistry at typical repository levels are in no way remarkable.

Greater knowledge of the effects of glaciers on the rock is important for an assessment of the long-term safety of the repository.

#### 4.6.4 Methods and Instrument Development

Ever since the geological field surveys started at the end of the 1970s, systematic work has been conducted to develop, improve and to render the methods and instruments more effective for the collection of geological data in the field. The goal is to have suitable methods and instruments available for high-quality collection of such data as are required for characterization of a rock volume for a final repository or for assessment of the safety of such a repository. The requirements on the quality of the data entail requirements on the accuracy and the reliability of the measuring equipment. A great emphasis is placed on the importance of being able to carry out measurements efficiently, since the number of measurements on a given site is very large.

Methods and instruments exist today for measurement of fundamental geological, geohydrological, geophysical, geochemical and rock mechanics parameters from the ground surface and in boreholes down to a depth of 1 000 m. However, technological progress is constantly creating new possibilities for the development of new instruments or data collection systems. Detailed site investigations and investigations from tunnels make new demands on measuring methods and instruments that must be met during the 1990s. If the need should arise for measurements at a much greater depth than 1 000 m, this will require additional instrumentation.

#### 4.6.5 Hard Rock Laboratory

The reasons for building an underground research laboratory were briefly described in R&D-Programme 86 and are given in greater detail in a background report to this R&D-programme. In summary, the most important reasons are:

- verification of methods for surface and borehole investigations,
- testing of methods for detailed site characterization with shaft sinking or tunnelling,
- opportunity, in a realistic environment and on a large scale, to investigate conditions of importance for safety, for example groundwater flow and associated transport of solutes,
- opportunity, in a realistic environment, to carry out demonstrations and long-term tests of the interaction between engineered barriers and rock,
- method development for rock engineering works, waste handling and backfilling.

Investigations of conceivable final repository sites carried out thus far – on so-called study sites – have only involved measurements on the ground surface and in boreholes. Investigations have also been carried out in and from tunnels at Stripa and SFR and in connection with certain construction work for other purposes. There is a need to directly verify the results of surface and borehole investigations with systematic observations from shafts and tunnels down to the depth of a final repository.

Some of the technology and methods for carrying out site investigations have been developed and tested at Stripa. However, since Stripa is an abandoned mine, it is not possible to test all aspects of the methods there. Tests in a previously undisturbed area provide additional opportunities for developing and refining the methods before they are used “for real”.

The future research should above all be devoted to integrate and complete the picture that has been obtained from the previous investigations at different sites. An initial integration attempt is being made within Phase 3 of the Stripa project, where a site characterization and validation test (SCV) is being carried out with respect to a rock volume on the 100 m scale. Prior to the siting of the final repository, an integration attempt should be made on a large scale to obtain more experimental data for the long-term safety assessment.

The pre-investigations for the siting of the Hard Rock Laboratory in the Simpevarp area were begun in the autumn of 1986. Studies have been carried out on different scales, both regionally and locally. The results have shown that favourable conditions exist on Äspö north of Simpevarp for constructing the Hard Rock Laboratory, of which the following can be mentioned:

- A relatively homogeneous rock block with few, well-defined groundwater-conducting structures exists on southern Äspö (where the access tunnel to the laboratory can be built).

- Nearby the above are a regional shear zone and areas with very homogeneous Småland granite.

SKB has thereby found that the different geological and hydrological conditions required for the planned tests exist on southern Äspö.

## 4.7 CHEMISTRY

### 4.7.1 Goals of R&D in the Chemistry Field

The main goal of the chemistry programme is to know the chemical environment in and around the repository and to determine the chemical retention of radionuclides. Both of these aspects are of importance for the long-term safety of the final disposal of radioactive waste.

The ambient chemical environment and how it can be altered naturally or by components in the repository are crucial factors for the chemical stability of the barriers. Examples of conditions that are affected by the composition of the groundwater are buffer stability, rock porosity (especially in the near field), canister corrosion, dissolution and leaching of the waste form and, finally, radionuclide chemistry. The chemical reactions take place in the aqueous phase and the point of departure for water composition is the undisturbed groundwater. An initial sub-goal is therefore to determine the normal composition of the groundwater by sampling and analysis. The next sub-goal is to determine what variations in water composition can arise through natural processes and through the influence of the repository and its components. This in turn requires investigations of minerals, and especially fracture minerals, that influence the composition of the water. Fractures also bear traces of previous changes.

Hydrogeological investigations of flow conditions are of importance for understanding the water composition. Conversely, studies of water chemistry, and in particular the water's content of stable and radioactive isotopes, actively contribute to supporting conclusions about the hydrogeological conditions.

If radionuclides from the waste should come into contact with the groundwater, the barrier provided by chemical retention will be of great importance. Retention takes place through precipitation, sorption and diffusion. A radionuclide that is exposed to water can be poorly soluble, diffuse slowly or precipitate completely in the near field. It can be held back by sorption on mineral surfaces or penetrate into the micropores in the rock and thereby be retarded or completely withheld from transport with flowing groundwater. An initial sub-goal is therefore to determine these processes and provide reliable constants and functions that describe the processes quantitatively.

Phenomena that can short-circuit or otherwise prevent important retention processes naturally deserve particular attention. An important second sub-

goal is therefore to analyze and test the transport characteristics of certain aggregates such as colloids, natural organic complexes and microbes, which can act as carriers of radionuclides in the water.

Three different approaches are used to validate the conclusions and models that are used in the safety assessment to describe the chemical environment and radionuclide retention: independent laboratory tests, in-situ tracer tests and studies of natural analogues of the final disposal of radioactive waste. Simulations in the laboratory provide an opportunity for full verification. In-situ tests offer a realistic environment and scale. Studies of natural analogues are used to support the assessments of the chemical environment and radionuclide retention that must be valid for very long spans of time.

### 4.7.2 Present-day State of Knowledge

#### Hydrochemistry and Geochemistry

The site investigations and the water sampling at Stripa and Forsmark (SFR) have shown that saline groundwaters are very common, especially in coastal areas. The saline groundwaters are relatively old, and where they occur the groundwater flux is very low. Water under land has proved to be of meteoric origin. Water under the sea contains traces of sea water.

The deep groundwaters are reducing. They completely lack oxygen and instead contain sulphide and iron(II). The contents of sulphide and bivalent iron are low as a rule, in other words the redox buffer capacity of the water is low. This capacity is instead present in the minerals. Carbon dioxide weathering releases eg iron(II), but how great the accessible capacity is remains to be demonstrated. Equipment has been developed for sampling and analyzing gases dissolved in the groundwater.

The use of isotope methods to characterize the "age", origin and flux of the water has been tested. A large number of different methods have been tried within the Stripa project by prominent experts in the field. There is now a selection of methods that are practically useful for site investigations and that provide relevant information.

Analysis of fracture minerals has provided an opportunity for interpreting the chemical evolution of groundwater and verifying models for groundwater movement.

Computer calculations have been carried out with advanced geochemical models to interpret the chemistry of the groundwater and predict the chemical disturbances to which a repository will give rise.

#### Radionuclide Chemistry

Thermodynamic constants that describe the solubility and hydrochemistry of radionuclides have been measured and compiled, often in cooperation with foreign experts and organizations. Most of the work has

been devoted to actinides, particularly uranium. The influence of phosphate remains to be shown. Co-precipitation has been tested and models developed. It should now be possible to include the co-precipitation phenomenon in a safety assessment. Co-precipitation of radionuclides with iron hydroxides and calcite remains to be investigated.

Sorption and diffusion of radionuclides in rock, bentonite and concrete have been measured. An extensive body of data on diffusivities and sorption coefficients exists. What remains is above all to explore the effect of additives to bentonite and the importance of natural reducing conditions, and to obtain a deeper theoretical understanding of sorption and diffusion on mineral surfaces.

The influence of natural organic complexes (humic and fulvic acids) on radionuclide retention has been investigated. These substances clearly bind radionuclides, and this can reduce sorption somewhat. The presence and influence of inorganic particles (colloids) and microbes in the groundwater has been investigated. Microbes have been found in deep groundwaters. The occurrence and stability of groundwater colloids has been investigated. Radionuclide uptake on these aggregates largely remains to be investigated.

The possible influence of radiolysis on a repository has been tested in numerous experiments. Theoretical predictions and calculations have largely been confirmed. Hydrogen is formed, as well as oxidants in the form of hydrogen peroxide.

### Chemical Transport and Validation

Models for water flow and radionuclide transport in an individual fracture with channelling have been developed. Coupled transport-geochemistry models have been further developed and applied to describe the interaction between concrete and bentonite and the formation of a redox front.

Laboratory tests have been conducted to validate models for transport of redox-sensitive radionuclides in natural rock fractures. So far, the tests have only involved technetium.

Tracer tests have been carried out in Finnsjön, Hylte and Stripa. Transport on different scales has been studied, from a few centimetres to a couple of hundred metres, and in different conductive media, from the sound rock to fractured zones. Non-sorbing tracers have been used for the most part. The methodology has been refined and different models for transport have been tested, including channelling models. The transport in the fracture zone at Finnsjön can be described with a porous continuum model, while the transport at Stripa shows signs of strong channelling. A series of experiments was started at Stripa in 1982 to validate diffusion into the rock matrix. They have now been completed and show that solutes can penetrate into seemingly quite impervious rock. This is an important mechanism for radionuclide retention.

Studies of natural analogues have been concentrated to the Poços de Caldas project.

Results from the laboratory tests, the tracer tests at Finnsjön and Stripa (3D), as well as the Poços de Caldas project, are also being used to validate transport models within the international INTRAVAL project, which is under the direction of SKI.

## 4.8 BIOSPHERE STUDIES

### 4.8.1 Goals of Biosphere Studies

The goal of SKB's studies of the properties of the biosphere and of the behaviour of radionuclides in the biosphere is to be able to perform the consequence calculations of the safety assessment in a credible manner. The efforts will be concentrated on being able to estimate the consequences of different releases in a time perspective on the order of 10 000 years. Sub-goals in this process are to:

- attempt to quantify the uncertainties that stem from the fact that the biosphere is changing continuously,
- improve the body of data on which the dispersal models rest,
- validate the models, for example by studies of analogue dispersal processes.

### 4.8.2 Present-day State of Knowledge

Any activity releases from a final repository will probably take place so far in the future and over a such a long span of time that considerable changes in the properties of the biosphere can be expected to occur before or during the release process. This means that analyses of the consequences of a release will entail great uncertainties.

The greatest uncertainty factor in the biosphere has to do with the natural evolution of the ecosystems during the periods of time that can be considered realistic. Examples of processes in a shorter time perspective are:

- eutrophication of lakes and cultivation of old sediments (also due to land uplift),
- erosion of soils by wind and water,
- restratification of sediments in lakes and water courses,
- urban settlements, large asphalt surfaces, tunnels etc.

In a somewhat longer perspective, climatic changes and glaciation must also be taken into account. The question, however, is how meaningful it is to make dose estimates at this stage.

SKB's efforts during the past few years have been concentrated on the aging of lakes, ie the process whereby the bottom sediment of lakes is gradually transformed into farmland. Data from a lake in Södermanland has been collected and evaluated regarding water flow,



sedimentation rate, pore water properties, water quality during different phases etc. Modelling and variation analysis showed that the individual doses for some nuclides increased by several orders of magnitude when the lake's sediment was used as farmland. For other nuclides, the doses decreased by an order of magnitude. The biggest source of uncertainty is the rate of exchange in the lake's water and sediment. However, this scenario gives lower doses than when a well is assumed to be drilled close to the disposal area.

On their way to the surface, groundwater and accompanying radionuclides will leave the reducing environment in the rock and enter an oxidizing environment. For most relevant chemical compounds, this transition is associated with a drastic change in solubility. The transition often takes place in sediment or soil, but can also take place directly in free water.

A detailed study of groundwater discharge in lakes was initiated during 1987 in order to investigate how the chemistry and fauna of the bottom sediments in the discharge areas differ from those of the bottom sediments in other areas.

Research regarding the dispersal of radionuclides in the biosphere, and with some relevance for final disposal in geological formations, is being conducted by a few departments at the Swedish University of Agricultural Sciences, the University of Gothenburg, FOA4 and, to some extent, by Studsvik and Kemakta under contract to SSI and SKI. Risö in Denmark and VTT in Finland are other Nordic institutions where such research is being conducted. Other research on chemical substances in the environment may also be relevant to the disposal of radioactive waste.

# 5 FINAL DISPOSAL OF SPENT NUCLEAR FUEL. SUMMARY OF PLANNED RESEARCH AND DEVELOPMENT 1990 – 1995

## 5.1 GENERAL

The preceding Chapter 4 provided an overview of the present-day state of knowledge regarding the final disposal of spent nuclear fuel. In this connection, overall goals and secondary goals for different stages of the research and development in this field, as well as an overall plan for the necessary measures, were also presented. On the basis of this plan and the stated goals, a detailed research plan has been drawn up for the 6-year period 1990–1995. This plan is presented in Part II and in the background report on the Hard Rock Laboratory. A brief summary of the most important parts of this plan is presented in this chapter. Activities and research pertaining to the decommissioning of nuclear power plants are dealt with in Chapter 6.

## 5.2 RESEARCH AREAS AND PROJECTS

The planned research concerns the central questions for the development, design, construction, operation and safety of a final repository for spent nuclear fuel. In order to introduce some general systematics, the questions have been broken down into a number of research areas, and divided into two groups. The first group pertains to more fundamental areas of knowledge that, in certain respects, are independent of the design of the repository. The second group is more directly linked to specific aspects of certain designs. The borderline between the two groups is by no means a sharp one, nor is it particularly meaningful.

Important areas within the first group are:

- properties of the nuclear fuel in the repository environment,
- properties of the canister material in the repository environment,
- properties of the buffer materials in the repository environment,
- bedrock movements – bedrock stability,
- groundwater movements,
- groundwater chemistry,
- radionuclide chemistry – the chemical properties of the radionuclides in the repository and bedrock environments,
- transport of radionuclides with groundwater,

- radionuclide properties and transport in the biosphere.

Important areas within the second group are:

- conceptual design of the repository,
- siting of the repository,
- construction technology,
- sealing of rock fissures,
- adaptation to rock quality,
- manufacture and closure of canisters,
- manufacture and application of buffer material,
- interaction rock-buffer-canister; chemical/mechanical,
- investigation methods.

The research work is often conducted in the form of major projects, where each project may deal with several of the areas enumerated above. The most important projects or project groups within SKB's research programme are the following:

- the Stripa project,
- the Hard Rock Laboratory,
- a number of projects concerning natural analogues,
- other field investigations – Finnsjön, Lansjärv, Hylte,
- a large number of projects involving measurements in laboratories,
- projects concerning development of theoretical models,
- the SKB 91 safety assessment,
- projects concerning design and/or analysis – ie desk work that is not directly connected with experiments or any of the above projects/project groups.

Table 5-1 provides an overview of the research areas dealt with by the different projects or project groups.

## 5.3 RESEARCH PROGRAMME 1990–1995

Figures 5-1 and 5-2 show general timetables for the coming six-year period 1990–1995. The first figure, 5-1, presents activities of importance for siting of the final repository and associated R&D. The second, 5-2, presents some of the major research projects. As yet undefined projects concerning eg validation are expected to be added during the latter part of the period.

Table 5-1. Important research areas within SKB's R&D.

Project	Stripa	Rocklab	Natural anal.	Other field studies	Lab exp.	Theory formation	SKB 91	Design analysis
Fuel properties					*	*	*	*
Canister material properties			*		*		*	*
Buffer material properties	*		*		*		*	*
Bedrock movements		*		*			*	*
Groundwater movements	*	*		*		*	*	*
Groundwater chemistry	*	*	*	*	*	*	*	
Radionuclide chemistry					*		*	
Transport of radionuclides	*	*	*	*	*	*	*	*
Radionuclides in the biosphere				*			*	
Design of repository							*	*
Siting of repository				*			*	*
Construction technique		*						*
Adaptation to rock		*						*
Sealing of rock etc	*	*			*			*
Canister manufacture + closure					*			*
Buffer manufacture + application		*			*			*
Interaction rock-buffer-canister	*	*			*		*	*
Investigation methodology	*	*		*	*			*

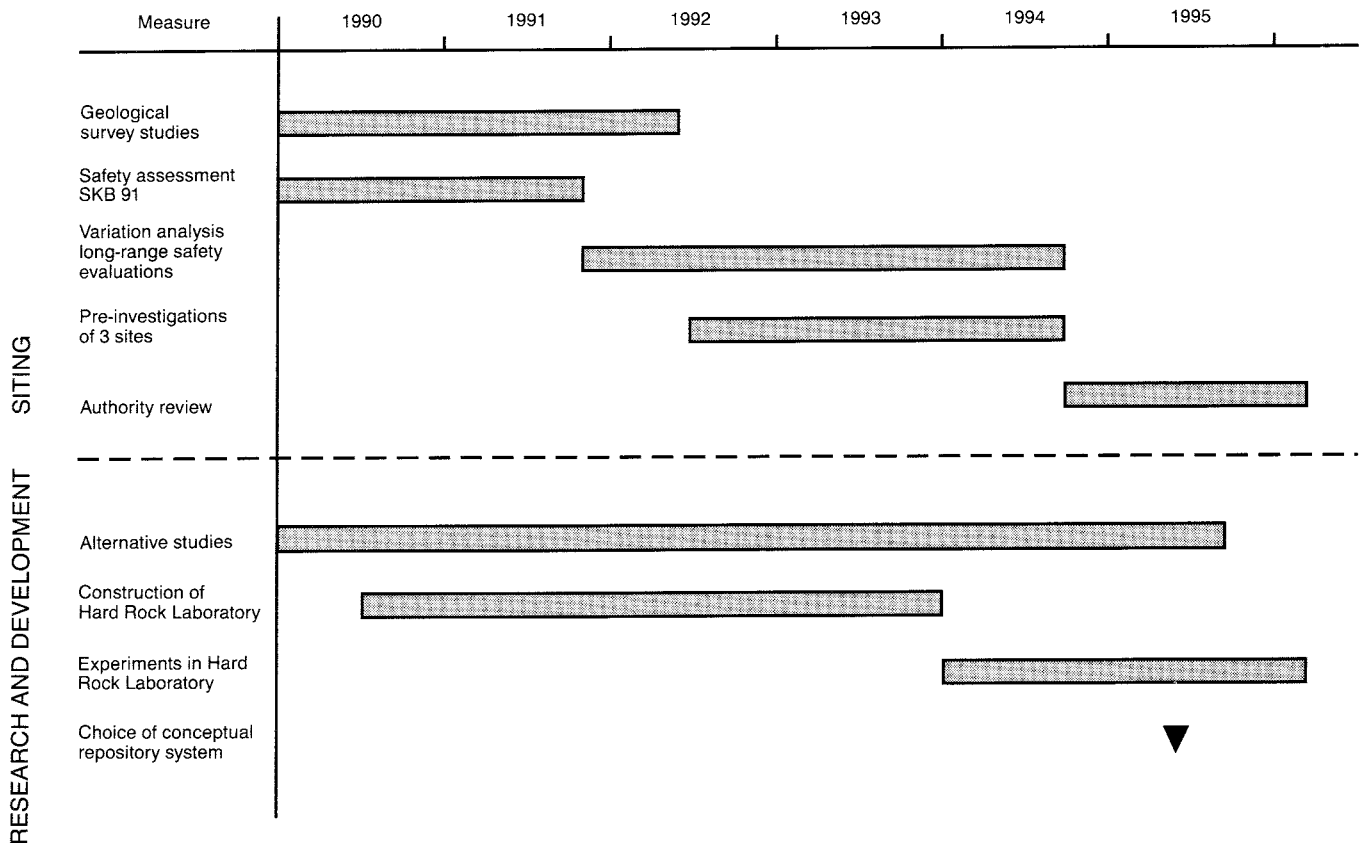

Figure 5-1. Timetable for the coming six-year period – siting and research concerning the final repository for spent fuel.

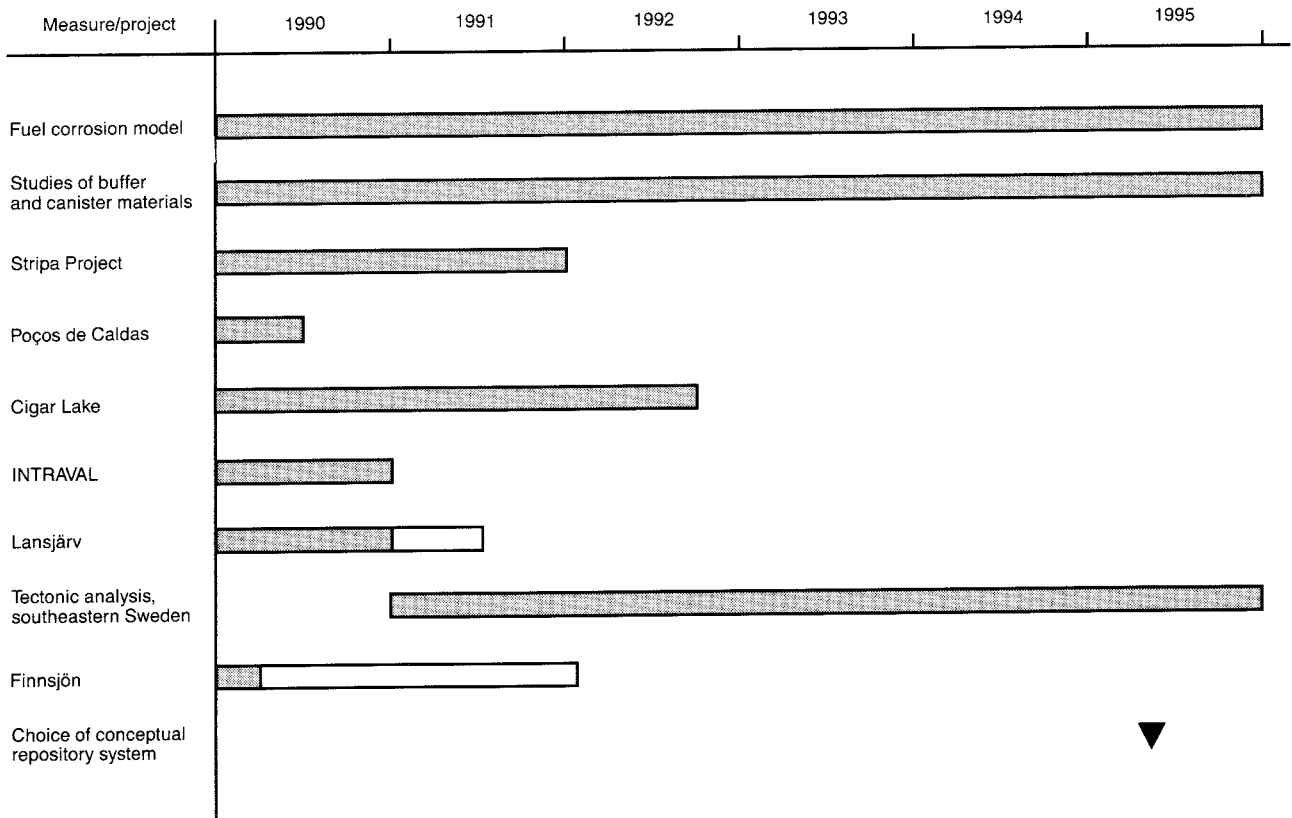

Figure 5-2. Timetable for important projects etc. during the six-year period 1990-1995.

### 5.3.1 Siting of the Final Repository

The plans for siting of the final repository were presented in some detail in section 4.3.2. The research work within this area will be focused on obtaining the material required for siting, which is summarized in the aforementioned section. For a more thorough presentation, the reader is referred to Chapter 2 in Part II.

### 5.3.2 Safety Assessment

By making safety assessment different repository concepts and knowledge pertaining to them are evaluated in an integrated fashion. Work within this area entails development of methods for how to do the evaluations, development and validation of calculation models, and the actual execution of performance or safety assessments.

#### The Period 1990-1992

##### SKB 91

A new integrated safety assessment will be carried out up to 1991. The repository will resemble KBS-3 with

some modifications. The geological data will be obtained from Finnsjön.

The models that will be utilized shall be defined and functioning early in 1990, and the data shall be compiled by the same deadline. Scenarios shall be defined early in 1990. The calculations and evaluations will be carried out during the second half of 1990 and the first half of 1991.

In order to permit extensive variation analyses in connection with the work, safety margins and very conservative assumptions will be avoided wherever possible. Variation analyses with SKB 91 as a basis will continue throughout the 1990s.

##### Near-field Transport

The compilation of a verified thermodynamic database for the chemical equilibrium calculations continues. During 1989/90, sensitivity studies will be conducted on the models utilized in KBS-3. This will provide a basis for priorities in the further development efforts. The models for the redox front in buffer and rock will be coupled.

During 1990 and 1991, calculations and variation analyses for SKB 91 will be conducted. After 1991, comparative studies of alternative near-field designs will be carried out.

### Far-field Transport

The development of different conceptual models for groundwater movements and transport of solutes in rock continues, including the buildup of databases.

The concepts in question are:

- channelling,
- flow in a two-dimensional stochastic fracture set,
- flow in defined discrete fractures.

One or more concepts will be selected during 1990 for use in SKB 91.

### PROPER

The development of a new integrated program for post-processing is in progress and is expected to be completed by 1990. During 1990/91, statistical methods will be refined and variance-reducing methods will be developed.

PROPER will be used as one of the tools for variation and uncertainty analyses for SKB 91. Development of submodels is expected to continue throughout the 1990s.

### Scenario Development

The methodological development for scenario analysis will be coordinated with international efforts, primarily within NEA, and will be adapted to the need for safety assessments and variation studies according to the general timetable. The scenarios that will serve as a basis for SKB 91 will be defined during 1990. A summing-up of the situation within the area is planned for R&D-Programme 92.

### Quality Requirements and Quality Control

A systematic review of the quality requirements that may be stipulated in different phases of the development work will be performed. Guidelines for quality assurance, QA, will be developed for handling, storage and documentation of data as well as for programming and documentation of computer programs.

### **The Period 1993 – 1995**

The studies of variability with SKB 91 will continue, with special emphasis on geological parameters and candidate sites. Parameters of importance for safety will be identified prior to the selection of sites for detailed characterization.

Development of the safety assessment methodology will continue and will be adapted to the research programme's needs and to the possibilities for further development.

Prior to the start of the detailed geological studies in 1995, the safety-related importance of sinking a shaft or a tunnel will be elucidated.

### **5.3.3 Design of the Final Repository**

The studies of very deep hole disposal and its safety aspects will be completed during 1990 with a comparative analysis vis-à-vis KBS-3.

A conceptual study of an alternative with long disposal tunnels from the coast out underneath the Baltic Sea will probably be carried out during 1992/93.

Alternatives of the type

- one or more canisters in each deposition hole,
- deposition in long holes drilled between transport tunnels,
- deposition in tunnels or drilled holes,

will be examined during the programme period to the point where properties of importance for the detailed site characterization have been identified.

### **5.3.4 Engineered Barriers**

#### **Spent Fuel**

The waste form spent fuel is given in the Swedish disposal alternative. Studies of spent fuel in the final repository environment are therefore an important part of the research programme. The emphasis lies on experimental investigations of the interaction between fuel, groundwater and other components in the near field. This work has been going on in its present scope since 1982 and is expected to continue for several years to come. The research is aimed at examining in greater detail the physicochemical processes that control the release of radionuclides from the fuel, both from the uranium dioxide matrix itself and from the grain boundaries and cracks within the fuel material. Of particular importance is to:

- clarify the distribution of fission products within the fuel matrix and at grain boundaries/cracks,
- determine the influence of radiolysis on the redox conditions at the fuel surface; this determines whether the dissolution of the matrix is limited by the solubility or by the oxidation rate,
- obtain reliable thermodynamic data for solubility-limited nuclides such as technetium and plutonium.

In connection with the experimental work, considerable efforts are also being devoted to the development of theoretical models. The goal is to have a model that can describe the process of fuel dissolution and be used for the optimization of the barrier system by the mid-1990s. The studies of spent fuel are being pursued in close contact with similar research in other countries, particularly Canada and the USA. Other major nuclear power countries have reprocessing as their main alternative and their research is devoted to vitrified high-level waste from such reprocessing.

## Canister

The continued work on canister material will be concentrated on augmenting the existing body of data so that the engineered barrier system can be selected in the mid-1990s.

Additional work is being done on copper, in particular with regard to pitting and techniques for welding of thick metal. Work is also being done to shed further light on the creep properties of copper at low stress levels.

The studies of steel will be concentrated during the period on hydrogen-producing corrosion. Steel can be an alternative if a canister life of about 1 000 years can be accepted. However, it can also be an alternative to lead as a filler (pressure-bearing) material in a canister where the corrosion protection consists of copper. In both cases, knowledge of hydrogen-producing corrosion is important for the performance and safety assessment.

Fracture mechanisms for a canister in the repository environment will be studied during the programme period. Tests intended to verify the theory for design and the necessary level of quality control may be required towards the end of the period.

## Buffer and Backfill

The work of clarifying the relationships between the microstructure of clays and factors of importance for nuclide transport in buffer material at different temperatures will continue and will be broadened to cover mixtures of natural material and crushed rock. Similarly, the studies of rheological properties of the buffer and backfill material will continue. The work to validate a theoretical model that describes thermomechanics, creep, shear deformation, swelling etc will continue.

Within the framework of the Stripa project, the studies of bentonite and a special cement as sealing material in thin rock fractures will continue. This work also includes an evaluation of the long-term stability of the materials. Collaboration with CEA, France, including heater tests at Stripa and analyses of gamma-irradiated clays will continue and is expected to be finished by the early 1990s.

Tests involving compaction of backfill material in tunnels may be conducted during the latter part of the period.

### 5.3.5 Properties of the Rock

#### Groundwater Movements

For the next few years, most of the planned work on groundwater movements will be carried out within the framework of projects connected to Stripa, Finnsjön and the Hard Rock Laboratory.

The development of conceptual models on different scales is of fundamental importance for increasing understanding of how groundwater flow in crystalline bedrock. Model development is planned on different scales. The Hard Rock Laboratory will work in parallel from a regional scale down to volumes of a hundred cubic metres or so. During the pre-investigation phase, regional groundwater models, discrete network models and simple transport models will be devised. These models will be tested and developed during the construction phase. The importance of a tracer test during the construction phase and the operating phase is specially noted here. The work at Stripa is devoted to volumes on a scale of one to about a hundred metres. The Site Characterization and Validation programme at Stripa will yield material permitting several different types of models to be tested. Three different groups are working with the modelling of the experiments within the framework of the project. Great efforts are being devoted within the "Sealing of Fractured Rock" test to the "disturbed" zone around deposition holes and tunnels. The tests at Finnsjön deal with transport on a far-field scale (several hundred metres).

A thorough evaluation of the extent to which the tracer tests are applicable is required for the continued experimental planning in order to distinguish between different conceptual models. Such an evaluation is foreseen both for Stripa and the Finnsjön tests. With an integrated evaluation of these tests, it will be possible to determine which additional experiments can contribute toward an improved analysis of the flow of the groundwater in rock. An evaluation is planned during 1992. This may influence the planning of tracer tests at the Hard Rock Laboratory.

An important question is to what extent the conceptual models are based on a complete set of data. This set of data includes data collected in surface investigations, in boreholes and in tunnels. As the field investigations progress, the set of data for description of flow paths will grow. It is difficult to prove that the investigations are ever complete. It is therefore important that uncertainty analyses be systematically conducted regarding the influence of such factors as overlooked fracture zones on the calculation results. Systematic uncertainty analyses will be carried out in SKB 91.

The work on development of numerical calculation models for groundwater flow in fractured rock will continue. Both models based on the "equivalent porous medium" approximation and network models will be tested.

The geometry and properties of vertical and sub-horizontal zones are of great importance. It is urgent to test better equipment and further refined evaluation methods in order to obtain a description of the frequency and extent of the subhorizontal zones in an early stage of the investigations. The deeper analysis can take place at the Hard Rock Laboratory.

As mentioned above, the disturbed zone is being studied within the Stripa project in the injection-grout-

ing test. Evaluation of this test and of the tests being conducted in the Canadian URL at the 240 m level will serve as a basis for possible supplementary tests in the Hard Rock Laboratory. Such an evaluation should take place in 1992.

### **Stability of the Rock**

It was noted in R&D-Programme 86 that a deeper analysis of ice ages and land uplift may be deemed necessary. This proposal was supported by a number of reviewing bodies, both national and international.

In order to best be able to compile knowledge and evaluate the possible importance of ice ages and land uplift for the assessment of the repository's safety, TVO in Finland and SKB have decided to carry out parts of this work jointly. Of particular interest is to examine whether an ice age is preceded by permafrost to great depth, whether the groundwater chemistry is dramatically changed under a glacier, whether easily soluble fracture minerals can be dissolved and increase the groundwater flux at the repository level and whether deglaciation leads to low effective stresses at great depth in the rock and large movements in the bedrock. Most of this work is expected to be concluded by 1992. The evaluation can lead to specific proposals for supplementary data collection.

In the commentaries on R&D-Programme 86, a number of reviewers pointed out the importance of tectonic analysis. The planned activities around Lansjärv that are described in Chapter 4 were judged to be exemplary, but several reviewing bodies were doubtful as to whether it was possible from these investigations to devise an investigation methodology for identifying neotectonic phenomena within other areas as well that do not exhibit as clear traces as at Lansjärv.

Several reviewing bodies also pointed toward the importance of understanding the large-scale structures in a regional context.

SKB deems it advisable to carry out a deeper tectonic analysis in the regional area that surrounds the planned underground Hard Rock Laboratory at Äspö. The previous regional and local investigations have yielded an excellent body of data to serve as a point of departure. As in the case of the Lansjärv investigations, it is urgent to describe the presence of possible recent fracture formations, to describe ongoing processes in the area, to clarify the presence of ongoing movements and to locate potential zones of movement. It is deemed valuable that the tectonic understanding be supported with numerical modelling.

The investigations at Lansjärv have for the most part been carried out according to the plan set forth in R&D-Programme 86. The results indicates the need for supplementary field work during 1990/91 before a final account can be given, however.

In view of the fact that the Lansjärv project has not yet been fully concluded, it has been deemed advisable to carry out the planning of the measures for the deeper

tectonic analysis during 1990 so that a coherent and goal-oriented project can be commenced in 1991. In such a project it is also appropriate to formulate guidelines on how a repository should be designed with a view towards possible future movements.

Effects of earthquakes will be further studied in the light of experiences from other countries where large earthquakes are common.

### **5.3.6 Method and Instrument Development**

As has emerged in previous sections, the work within this area has primarily been associated with surface investigations and borehole investigations. The activities during the coming years will mainly be associated with the Hard Rock Laboratory and the coming detailed site characterization. The emphasis there will be on methods and equipment that are suitable for investigations from shafts and tunnels as well on instruments for long-term observations. A continued development of methods for tracer tests is foreseen within the framework of the projects at Stripa, Finnsjön and the Hard Rock Laboratory. Within the Stripa project, planned development of radar and seismic technique will be carried out in single boreholes and between boreholes.

### **5.3.7 Hard Rock Laboratory**

The project is divided into three phases – the pre-investigation phase, the construction phase and the operating phase – which are described in general terms below.

The pre-investigation phase includes siting of the Hard Rock Laboratory and description of the natural conditions in the bedrock. The work is being conducted in three stages – siting, site description and prediction – of which two stages have been completed and the results reported and the third is in progress (September 1989). Planning of the project's construction and operating phases is being conducted in parallel with the pre-investigations. The pre-investigation phase will be concluded in 1990.

During the construction phase 1990–1994, a number of investigations and tests will be conducted in parallel with the construction activities. Construction of the laboratory is planned to take place in two stages. The first stage involves tunnelling to a depth of about 350 metres. After this stage, an opportunity will be provided – for up to six months – to make a summary evaluation before tunnelling in the second stage continues to the 500 m level. At the end of the second stage, some of the test stations that will be used during the operating phase will be characterized and built.

The investigations in the construction phase will provide material for validation of the expectation models developed during the pre-investigation phase. Furthermore, data will be obtained permitting the progressive improvement of previously made predic-

tions. The investigations will be conducted along the surfaces of the access tunnel as well as in boreholes from the ground surface and from the tunnel.

It is essential that the degree of detail of the investigations during the construction phase be increased as the work progresses, since the properties of the bedrock nearest the deposition holes and tunnels are of the greatest importance for the safety of a final repository. Investigations conducted on the future main level, about 500 m below the surface, will be more detailed than at the beginning of the tunnelling work.

If later investigations within the framework of the general research programme should show that the final repository ought to be situated deeper than about 500 m, expansion of the Hard Rock Laboratory to greater depth may be necessary.

The operating phase will begin in 1994. At the present time, it is only possible to indicate the general thrust of the investigations and tests planned for the operating phase. The design and execution of the tests during the operating phase will be influenced by the results of other projects and by the outcome of the construction phase. The planning calls for conducting the following proposed tests:

- large-scale tracer tests,
- block-scale tracer tests,
- radionuclide migration,
- block-scale redox tests,
- methodology for repository construction,
- pilot tests, repository systems.

The purpose of the large-scale tracer tests is to characterize transport in the far field and yield data for validation of models for far-field transport.

Block-scale tracer tests will be performed on an intermediate scale. The situation in a final repository with canisters deposited in rock with low hydraulic conductivity and with a “respect distance” to the nearest major water-bearing zone will be simulated. The results will be evaluated and used to validate transport models on a block scale, ie over distances of 10–100 m.

Radionuclide migration will be carried out to test the dissolution and migration of radionuclides in a realistic environment. Previous investigations have shown that solubility, sorption on fracture faces and diffusion into the rock matrix reduce the transport of radionuclides in the bedrock. The data and models that describe the chemical properties of the radionuclides in the natural bedrock environment are, however, based for the most part on laboratory tests.

Block-scale redox tests will be conducted to quantify the redox capacity of the rock in the flow paths. Reducing conditions at repository depth are a necessary requirement for long canister life. The groundwater that has been sampled on different occasions and on different sites within the study-site investigations is always reducing, proving the reducing properties of the rock. The kinetics of the redox reactions between the bedrock

minerals and the groundwater require further study, however.

Methodology for repository construction is primarily aimed at demonstrating how the construction of a repository is to be accomplished. The investigation can be divided into the following sub-goals:

- develop a strategy for characterization of the near field,
- demonstrate in an appropriately chosen rock volume how the characterization is to be carried out,
- show how flexibility can be achieved in a repository system, ie adaptation of deposition tunnels and deposition holes to the properties of the rock.

“Pilot tests – repository systems” is a series of pilot and demonstration tests to be carried out after the main principles of repository design and systems have been finalized in the mid-90s. The goal is to validate the models and demonstrate function by clarifying the interaction between the rock and the selected buffers under conditions prevailing in disposal facilities. A further purpose is to develop and test methods and strategies for their application.

The programme for the Hard Rock Laboratory is described in detail in a separate background report to this programme.

## 5.3.8 Chemistry

### Geohydrochemistry

The research work during the programme period will primarily be associated with the work at the Hard Rock Laboratory. During the second half of the period investigations on proposed repository sites will also be included. Important investigation objects are:

- identification of different types of saline groundwaters,
- redox buffer capacity of the rock,
- isotope studies in water and fracture minerals,
- fracture mineral investigations,
- geochemical model calculations,
- analysis of dissolved gases,
- analysis of groundwater in non-transmissive rock units.

### Radionuclide Chemistry

The investigations will continue according to previous guidelines, ie the emphasis is on radionuclide retention in the repository and surrounding host rock and the chemical conditions that control this. The following objects are important and are included in ongoing or planned activities:

- Compilation of thermodynamic data and augmentation with in particular data on phosphates.



- Kinetic tests with technetium.
- Model for co-precipitation with iron hydroxides and calcite.
- Demonstration of natural reduction.
- Model for uptake and mobility of radionuclides on colloids and in organic complexes.
- Influence of microbes on retention.
- Importance of multinuclide mixing, high salinity and high rock/water ratio for sorption.
- Theoretical model for sorption on and diffusion in rock minerals.
- Study of feasibility of adding “getters” to backfill.
- Summary of tests with sorption and diffusion in concrete.
- Review of radiolysis model.

### **Chemical Transport and Validation of Transport Models**

Development and application of transport models is aimed at the safety assessment for SKB 91. Validation of models for release, transport and retention of radionuclides consists of the application of models to own and others’ simulating laboratory tests, in-situ tracer tests and results of studies of natural analogues. The following objects are of importance:

- development of transport models that include the channelling phenomenon,
- development of geochemistry-transport coupled models,
- execution and evaluation of laboratory tests concerning movement in an individual fracture,
- execution and evaluation of tracer tests,
- evaluation of different natural analogue investigations, primarily the Poços de Caldas analogue.

With regard to tracer tests, the results of the tests at Stripa, Finnsjön and Hylte are currently being evaluated. Further tracer tests are planned at Finnsjön and at the Hard Rock Laboratory.

### **5.3.9 Natural Analogues**

Through March of 1990, the research work will be concentrated to the Poços de Caldas project. Evaluation will take place partly within the project and partly outside in a manner agreed upon with the members of the project. A participation in the Cigar Lake project is currently being discussed with AECL in Canada.

Evaluation and application of the results of natural analogue studies is in no way limited to projects where SKB is, or may become, more directly involved. Through active participation in joint international projects such as INTRAVAL and CHEMVAL, through bilateral exchange and through participation in the National Analogue Working Group, NAWG (an EC initiative), experience from other similar studies is also being gathered.

### **5.3.10 Biosphere Studies**

The purpose of the biosphere studies is to further refine the models that describe how radionuclides are transported in the biosphere and how they can reach man.

The study of the transport pathways in the biosphere will continue both to examine more closely how radionuclides reach the biosphere via low-lying discharge areas, and to make use of the Chernobyl fallout as a large-scale tracer test on two study sites. The migration of different nuclides in soil and biomass as well as shallow parts of the rock and the groundwater will be modelled. Greater efforts may be required to establish the role of sediments as an ultimate sink for the radionuclides.

SKB’s support of the efforts to validate biosphere models via international participation in BIOMOVS will continue.

In connection with the Hard Rock Laboratory, the surrounding local ecosystem will be explored in a manner similar to the studies that need to be done for a final repository location. The occurrence of natural radionuclides in superficial waters, soils and discharge areas will be measured, partly to document the undisturbed conditions around the Hard Rock Laboratory, and partly to further refine the body of data and to test measuring methodology.

In connection with the definition of scenarios for SKB 91, certain discussions concerning the changeability of the biosphere will be documented.

### **5.3.11 International Cooperation**

In international cooperation extensive activities are being pursued in the form of experiments, model development, site investigations, data collection etc within the field of nuclear waste management. Broad international cooperation takes place within the UN’s International Atomic Energy Agency (IAEA) and within the OECD’s Nuclear Energy Agency (NEA). In addition, cooperation agreements exist between those countries that are actively conducting research and development within the field.

#### **SKB’s Cooperation Agreements with Foreign Organizations**

Through SKB, Sweden has formal cooperation agreements with the following organizations in other countries:

- USA – US DOE (Department of Energy),
- Canada – AECL (Atomic Energy of Canada Ltd),
- Switzerland – NAGRA (Nationale Genossenschaft für die Lagerung Radioaktiver Abfälle),
- France – CEA (Commissariat à l’Energie Atomique),
- EC – EURATOM,

- Finland – TVO and IVO,
- Soviet Union – SCUAE (State Committee on the Utilization of Atomic Energy),
- Japan – JNFI (Japan Nuclear Fuel Industries Company, Inc).

In addition, an exchange of information without any formal agreements exists with West Germany, Belgium, Great Britain and the other Nordic countries.

Within the framework of the agreements general reviews of the signatories' waste programmes and plans takes place at approximately one-year intervals. The agreements provide increased opportunities for specialists within the field of nuclear waste management to exchange up-to-date information.

### **Cooperation within IAEA**

An advisory expert group (the International Waste Management Advisory Committee, INWAG) was recently created. This group arranges opportunities for information exchange within different special fields through Joint Research Programs. SKB has an observer in this expert group.

The reports published by IAEA consist of proceedings from international symposia, status reports and methodology descriptions within important areas undergoing rapid development, as well as guidelines and standards within established fields of activity. In addition, a catalogue of ongoing research projects in member states is published annually.

### **Cooperation within OECD's Nuclear Energy Agency**

One of OECD/NEA's principal areas of cooperation is radioactive waste management in the member countries. These questions are dealt with by the Radioactive Waste Management Committee (RWMC), where SKB is represented. The cooperation takes place within joint international projects and working groups formed to facilitate the exchange of information. SKB participates in the following groups and projects:

- PAAG – Performance Assessment Advisory Group,
- ISAG – Advisory Group on In Situ Research and Investigations,
- PSAC – Probabilistic Safety Assessment Code Users Group,
- Cooperative Programme for the Exchange of Scientific and Technical Information Concerning Nuclear Installation Decommissioning Projects,
- Expert Group on Geochemical Modelling and Data,
- The Stripa Project,
- TDB – Thermochemical Data Base.

### **Other International Projects**

International comparisons of different calculation programs for groundwater flow are being conducted in the HYDROCOIN project. This project is headed by SKI, and SKB has carried out calculations on three of the seven test cases included in the project.

For validation of calculation models for radionuclide transport in the geosphere, SKI has initiated a new project called INTRAVAL. Five of the 14 test cases are associated with SKB.

Within the field of corrosion of spent fuel, a number of Spent Fuel Workshops have been held on SKB's initiative. Since the experimental research work within this area is both costly and time-consuming, it is important that opportunities be provided for an informal exchange of results and experience.

## **5.4 EXECUTION OF THE PROGRAMME**

The Swedish Nuclear Fuel and Waste Management Company, SKB – has been commissioned by its owners, the Swedish nuclear utilities, to develop, plan, construct and operate facilities and systems for the management and disposal of spent nuclear fuel and radioactive waste from the Swedish nuclear power plants. Within the framework of this commission, SKB will also be responsible for the research and development described in this programme.

SKB is organized in two divisions:

- Research and Development.
- Systems and Facilities.

In addition there are staff units for Public Affairs and Media Relations as well as for Finance and Administration. A special group is responsible for coordination of Consulting Services offered to foreign customers.

Overall responsibility for the execution of the R&D-programme lies with SKB's R&D division. Matters pertaining to the decommissioning of nuclear facilities are handled within Systems and Facilities. The R&D division currently has a director and fourteen academically trained specialists, five of whom are mainly occupied with safety assessment. In addition, a project manager for the Hard Rock Laboratory has been borrowed from Systems and Facilities.

In order for the R&D activities to be efficient, it is necessary to have well-defined goals and delimited frames. At the same time, the planning must be flexible enough to enable the programme to be continuously modified in response to the results obtained both from SKB's own research activities and from international activities. This means that SKB is also responsible for periodically adapting the programme to the current state of knowledge at various points in time.

The work will be executed primarily through contracts awarded to universities, institutes of technology, research institutions, industrial enterprises, engineering firms, consultants and other Swedish and foreign groups with the necessary qualifications. At present, approximately 250 persons outside SKB are involved in the execution of the current programme. The task for SKB's own staff is primarily to plan, initiate and coordinate the work and to compile and document the results and take responsibility for their application. Another important task is to keep track of national and international developments within relevant fields of research. This is a prerequisite for being able to direct the contracts and the work so that appropriate and effective contact networks are created and maintained.

Larger, more extensive efforts that involve several research fields are organized as separate projects with their own project managers and their own project organizations. Examples are the Stripa project, the Hard Rock Laboratory and the Poços de Caldas project.

Special reference groups exist within certain specialist areas. These groups include SKB's own specialists as well as specialists from industry, universities, consulting agencies and other bodies. Goals, strategies, contents and results of the R&D-work are reviewed and assessed regularly within these groups. Review and assessment provides a basis for continuous revision and prioritization of plans and objects.

One goal of the R&D-programme is to collect the necessary support material for a site-specific siting application to be submitted a couple of years after 2000. This requires analysis and evaluation of various alternatives for the design and siting of the final repository. In

order to get a proper balance of the R&D-work on different alternatives, integrated performance assessment groups are organized with representatives for concerned areas. The groups define the assessments to be made and the models that can be used. They also evaluate the results and their relevance with respect to uncertainties in data and models. Safety, cost assessments, technical feasibility, development potential and development needs play a prominent role in the evaluations.

In order to permit scientific review and discussion of the research results, the results will, as before, be widely distributed internationally. This is done through publication in SKB's own technical reports and in scientific journals, through participation in conferences and through open, extensive contacts. An annual summary is published in the SKB Annual Report.

An important and necessary feature of the R&D-programme is the exchange of information and the opportunities for cooperation that follow from the bilateral agreements signed with counterpart organizations in other countries.

SKB strives for great openness and opportunity for public insight into its activities. This applies in particular to the research work. Society and the general public have high demands on information regarding waste management. In order to satisfy these demands, SKB is expanding its resources to provide easily accessible information to interested persons, above and beyond its normal technical reporting. SKB will regularly publish information on plans, work in progress and the results of the activities associated with the research programme.

# 6 DECOMMISSIONING OF NUCLEAR POWER PLANTS

## 6.1 BACKGROUND

When a nuclear power plant is taken out of service, parts of it are contaminated with radioactivity. This means that the decommissioning must be carried out in a controlled manner with due consideration to the need for radiation protection measures beyond conventional industrial safety. Furthermore, certain parts of the decommissioning waste must be managed and disposed of as radioactive waste, see Section 2.2.4.

A number of small research reactors and a few small nuclear power plants have already been decommissioned at a number of locations in the world. At present, several medium-sized nuclear power plants are being decommissioned, for example in Japan, the USA, West Germany and Great Britain. As yet, no full-size plants have been taken out of service and decommissioned.

Experience of decommissioning in Sweden is limited to the decommissioning of the R1 research reactor in Stockholm and several smaller facilities at Studsvik.

These activities and a number of studies show that the methods for decommissioning nuclear power plants are available today. Most of the equipment that is needed is already available and is used routinely in connection with maintenance and modification work at the Swedish nuclear power plants. It is only for dismantling of the reactor vessel and its internal components, and for demolition of the concrete shield nearest the reactor vessel, that methods are needed that have not yet been used in Sweden. Experience from the use of such methods is being obtained in connection with the ongoing decommissioning projects mentioned above. The Swedish nuclear power industry has good insight into these projects through a cooperation programme that has been organized under the auspices of OECD/NEA and where SKB is in charge of the secretariat and programme coordination.

## 6.2 GOALS AND OVERALL PLAN

The goal of the decommissioning work after a nuclear power plant has been taken out of service is that the site can be restored and reclaimed after some time so that it can be used without any radiological restrictions. This shall be carried out in such a manner that neither the personnel occupied with the decommissioning and dismantling work nor the general public are exposed to unnecessary irradiation. Decommissioning will proceed in

several stages. IAEA has defined three stages in the decommissioning work /6-1/, which are defined by the physical status of the plant.

In **stage 1**, fuel and liquids have been removed from the reactor and the control systems disconnected. Access to the plant is restricted and the plant is kept under surveillance and inspected periodically.

In **stage 2**, most of the components containing reactivity have been concentrated to a limited volume, which has been sealed. Less surveillance is required than in stage 1, but continued periodic inspection is desirable.

In **stage 3**, all radioactive materials (above the declassification limit) have been removed and the area has been released for unrestricted use. Stage 3 is sometimes called "green field".

It is not necessary that the decommissioning is made in three stages. Stage 2 is mainly applied if decommissioning is intended to be delayed beyond the time the plant is taken out of service. It is common to speak of a delay of 30 to 100 years. If the decommissioning work is intended to commence within a few years of shutdown, it is natural to proceed directly via stage 1 to stage 3.

It has not yet been decided which schedule will be used for the Swedish nuclear power plants. A number of different factors will influence this decision. The most important are what other kind of activity is planned on the site and the availability of personnel familiar with the plant. Radiation protection aspects and, not least, general political aspects may also influence the decision.

The procedure for decommissioning the Swedish nuclear power plants has been described in a report from SKB, "Technology and Costs for Decommissioning of Swedish Nuclear Power Plants" /6-2/. This report shows that a decommissioning can be commenced approximately one year after the last reactor has been shut down at a nuclear power plant. Putting the plant in mothballs for 30-50 years before the actual decommissioning work is commenced is also shown to be a feasible alternative. The early decommissioning is recommended mainly in view of the availability of personnel familiar with the plant. A delay of decommissioning results in a lower radiation level, permitting certain simplifications of the decommissioning work.

This planning is not affected by the Swedish Parliament's decision in June 1988 on guidelines for the commencement of the nuclear power phase-out, see Section 6.3.1.

When the decommissioning work is to be carried out, a nationwide planning approach will be the most efficient. This will provide advantages in the form of more

efficient utilization of special equipment and specially trained personnel, as well as good opportunities for experience feedback.

Thus, the point of departure for the planning of the future decommissioning and of the need for R&D is that no decommissioning will be commenced prior to the year 2010. Depending on how the nuclear power site is planned to be used in the future, for example if it will be used for other power production, there may be reasons for starting the actual decommissioning work later.

## **6.3 ONGOING WORK**

### **6.3.1 Sweden**

Most of the technology required for the future decommissioning of the nuclear power plants is, as mentioned above, already available and is used routinely in connection with maintenance, repair and modification work at the nuclear power plants. Special equipment need only be developed for dismantling of the reactor vessel and demolition of heavy concrete structures. A great deal of work is being done within these areas abroad, and it is of great importance that this work be followed up. Independent efforts in Sweden are not warranted at this time.

A follow-up of repair and modification work takes place at every nuclear power plant. For certain major projects, it is of interest to conduct separate studies of what conclusions can be drawn from this experience for the future work of decommissioning. One example of this is the recently completed steam generator replacement at Ringhals 2.

A study was recently conducted to determine how the Parliament's 1988 decision on guidelines for the commencement of the nuclear power phase-out affects the planning of decommissioning /6-3/. The two reactors that may be candidates for an early phase-out, 1995/96, one at Barsebäck and one at Ringhals, are both integrated with another reactor that will continue in service. For safety reasons, it is therefore clearly inappropriate to begin their decommissioning before the other reactors have been taken out of service.

The planning of R&D within the field of decommissioning is therefore based on the assumption that extensive decommissioning work will not be commenced before the year 2010, at the earliest.

However, completed studies point toward some areas where development efforts are warranted now. One such area is the possibility of removing, transporting and disposing of the reactor vessel intact. A study of this is currently in progress.

### **6.3.2 Other Countries**

The most important work within the decommissioning field is being done in conjunction with the actual shut-

down of reactors and other nuclear facilities that have been taken out of service. So far, some 20-odd reactors have been decommissioned to stage 3, ie they have been dismantled and the radioactive components removed. In addition, a large number of plants have been taken out of service and decommissioned to stage 1 or 2. Most decommissioning projects have concerned experimental reactors or small power reactors. Only in recent years have some medium-sized reactors ( MWe) also been taken out of service.

In parallel with actual shutdown projects, some development of decommissioning methods is also being conducted. Usually it is connected with a given shutdown project, however. The work is largely being done on a national basis, but international work is also being conducted, primarily within the EC.

### **OECD/NEA's Joint Decommissioning Programme**

A special programme for information and experience exchange between ongoing shutdown projects has been organized within OECD/NEA. Most major shutdown projects are included in this programme. At present the programme includes a total of 14 projects in eight countries. A summary of the projects is given in Table 6-1. Seven of the projects aim at complete decommissioning to stage 3.

The joint programme includes an exchange of experience from day-to-day activities as well as more extensive discussions and information exchange concerning specific technical questions. Examples of such questions that have been discussed are melting of metallic waste, measuring methods for low-level waste, removal of asbestos and methodology for cost calculations and cost accounting.

The projects that are of special interest to Sweden are Shippingport, JPDR and Niederaichbach. Most of the decommissioning work has been completed at Shippingport. The reactor vessel has been lifted out intact and transported by barge to the final disposal site.

Within the JPDR project, which involves the decommissioning of a boiling water reactor, extensive testing and development of different decommissioning methods is being conducted. Of particular interest is the planned dismantling of the reactor vessel, which will be commenced at the end of 1989.

Dismantling of the reactor vessel is of special interest in Niederaichbach as well.

Through Shankar Menon of Studsvik, SKB has taken the responsibility of programme coordination and has thereby been given an opportunity to follow the different projects closely.

### **The EC's Research Programme**

The EC has been conducting a joint research programme within the field of decommissioning since 1979. At

**Table 6-1. OECD/NEA joint decommissioning programme. List of projects included.**

Facility	Type	Planned final stage
Eurochemic, Belgium	Reprocessing plant	Stage 3
Gentilly-1, Canada	Heavy water reactor, 250 MWe	Stage 2
NPD, Canada	Heavy water reactor, CANDU, 250 MWe	Stage 1
Rapsodie, France	Sodium-cooled fast reactor, 40 MWth	Stage 2
G2, France	Gas-cooled reactor 45 MWe	Stage 2
AT1, France	Reprocessing plant for fast reactor fuel	Stage 3
Niederaichbach, West Germany	Gas-cooled, heavy-water-moderated, 100 MWe	Stage 3
Lingen, West Germany	BWR, 256 MWe	Stage 1
MZFR, West Germany	Heavy water reactor, 58 MWe	Stage 1
Garigliano, Italy	BWR, 160 MWe	Stage 1
Japan Power Demonstration Reactor (JPDR), Japan	BWR, 13 MWe	Stage 3
Windscale Advanced Gas Cooled Reactor, Great Britain	AGR, 33 MWe	Stage 3
BNFL Coprecipitation plant, Great Britain	MOX fuel fabrication	Stage 3
Shippingport, USA	PWR, 72 MWe	Stage 3
West Valley Demonstration Project, USA	Reprocessing plant for LWR fuel	

present, the EC's second five-year programme is in its final phase and a third programme is about to start.

So far, the studies have primarily concerned different decommissioning methods as well as questions pertaining to activity content and waste management /6-4/. The following research areas have been covered:

- long-term durability of buildings and systems,
- decontamination,
- decommissioning methods,
- treatment of certain wastes: steel, concrete and graphite,
- large waste containers,
- estimation of waste quantities.

Furthermore, work is being done to formulate guidelines for decommissioning.

In the coming five-year programme, the emphasis will be shifted toward application and testing of different decommissioning methods under actual conditions.

An important lesson learned from the ongoing programme is that the quantity of metallic waste that needs to be disposed of can be considerably reduced, thanks

to progress within the field of decontamination and melting /6-5/.

### IAEA

Work is being pursued within IAEA aimed at summarizing the state of knowledge within different technical areas and formulating recommendations and advice for future licence applications for decommissioning.

IAEA also has a coordinated R&D-programme within the decommissioning field. SKB is participating in this programme with a study of handling of the intact reactor vessel.

### Miscellaneous

In addition to the joint international projects mentioned above, development work is being pursued within the field of decommissioning in a number of countries. Of special interest are the French programme being conducted by CEA and the work being done in Germany, for example at the Grundremmingen and Kahl reactors.

## 6.4 RESEARCH PROGRAMME 1990–1995

The timetable for carrying out the necessary R&D-work on decommissioning is closely linked to the timetable for the decommissioning of the nuclear power plants. As indicated above, the first decommissioning will not be commenced until a few years after 2010, at the earliest.

A few years before the planned start of decommissioning, a project group will be organized to plan the decommissioning work in detail. By this time the necessary information regarding decommissioning methods, classification of waste, transportation systems etc must be available. Most of the methods that are needed are already available and are being used in Sweden. In connection with the planning of the decommissioning, they will be adapted to this work. Development efforts will be required for some equipment. Since a great deal of development work is being done abroad, there is no need to start any separate Swedish projects during the coming six-year period.

The completed studies of decommissioning of Swedish nuclear power plant have indicated some areas where early measures are warranted. The most important are:

- study of the feasibility of disposing of an intact reactor vessel (see above),
- technology for dismantling of reactor internals,
- technology for demolition of the biological shield,
- management of asbestos insulation,
- methods and equipment for activity measurement of the waste for declassification or simpler disposal,
- decontamination for declassification,
- volume reduction of the waste by compaction or melting.

During the next few years, most of the work will be concentrated on the possibility of disposing of an intact reactor vessel. For other areas, efforts will be con-

centrated on following up activities abroad and experience from the operation of the nuclear power plants. Towards the end of the six-year period, it may prove necessary to conduct more systematic research in the other areas. An evaluation should then be made of the possibility of conducting tests in the disused Ågesta reactor.

The follow-up activities will take place as before through the programme coordination function within the OECD/NEA programme and through participation in the work of IAEA etc.

On two occasions, SKB has carried out a complete study of the technology and costs for decommissioning the Swedish nuclear power plants. The latest experience of decommissioning and maintenance work has been taken into account in these studies. A new decommissioning study is planned during the period.

Decommissioning produces a large quantity of slightly contaminated material that could be declassified, possibly after decontamination. Some experience exists from declassification at the nuclear power plants, which is done today with permission from SSI for each separate occasion. Before decommissioning is commenced rules and methods for declassification must be developed. The ability to measure low activity levels is of great importance in this connection.

Prior to the decommissioning of the nuclear power plants, the final repository for decommissioning waste, SFR 3, must also be completed. The time from initial planning to the finished facility has been estimated to be about seven years, which means that this work will not be commenced until a few years into the next century.

For the decommissioning work to be carried out efficiently, certain administrative questions must be resolved, for example what type of licences are needed and what type of accounting to the regulatory authorities is required for this purpose. This work lies within the sphere of responsibility of the regulatory authorities.

# REFERENCES PART I

## Chapter 1

- 1-1 Spent fuel and radioactive waste**  
Report of the AKA committee.  
SOU 1976:30 Part 1  
SOU 1976:31 Part 2  
SOU 1976:41 Appendix  
(In Swedish)
- 1-2 Handling of spent nuclear fuel and final storage of vitrified high-level reprocessing waste**  
November 1977  
Parts I-V  
Kärnbränslesäkerhet, KBS, Stockholm
- 1-3 Handling and final storage of unprocessed spent nuclear fuel**  
September 1978  
Parts I-II  
Kärnbränslesäkerhet, KBS, Stockholm
- 1-4 Act on the financing of future expenses for spent nuclear fuel etc, SFS 1981:669.**  
(In Swedish)
- 1-5 Final storage of spent nuclear fuel – KBS-3.**  
May 1983  
Parts I-IV.  
SKBF/KBS, Stockholm
- 1-6 Act on nuclear activities, SFS 1984:3.**  
(In Swedish)
- 1-7 Final storage of spent nuclear fuel – KBS-3.**  
February 1984  
Programme for research and development  
SKBF, Stockholm
- 1.8 Annual research and development Report 1984**  
June 1985  
SKB Technical Report TR 85-01, Stockholm
- 1-9 SKB Annual Report 1985**  
May 1986  
SKB Technical Report TR 85-20, Stockholm
- 1-10 SKB Annual Report 1986**  
May 1987  
SKB Technical Report TR 86-31, Stockholm

- 1-11 SKB Annual Report 1987**  
May 1988  
SKB Technical Report TR 87-33, Stockholm
- 1-12 SKB Annual Report 1988**  
October 1989  
SKB Technical Report TR 89-32, Stockholm  
(In print)

## Chapter 2

- 2-1 Same as ref 1-5.**
- 2-2 Lönnerberg B et al.**  
May 1983  
Encapsulation and handling of spent nuclear fuel for final disposal.  
SKB/KBS Technical Report TR 83-20, Stockholm
- 2-3 Pettersson S, Hedman T**  
Dec 1985  
Managing power station wastes.  
Nuclear Engineering International
- 2-4 Kärnkraftens slutsteg PLAN 89**  
("Radioactive waste management plan, PLAN 89")  
(In Swedish)  
SKB, June 1989, Stockholm

## Chapter 3

- 3-1 Same as ref 2-4.**
- 3-2 SKN PLAN 87 och förslag till avgift för år 1988**  
("SKN PLAN 87 and recommended fee for 1988")  
(In Swedish)  
National Board for Spent Nuclear Fuel, October 1987, Stockholm
- 3-3 Radioactive waste management plan, PLAN 82**  
June 1982  
Parts 1-2  
SKBF, Stockholm



- 3-4 **Slutförvar för reaktoravfall  
Slutlig säkerhetsrapport**  
("Final repository for reactor waste, final safety report")

(In Swedish)

SKB, September 1987, Stockholm

- 3-5 **Centralt lager för använt bränsle  
Slutlig säkerhetsrapport.**  
("Central interim storage facility for spent nuclear fuel, final safety report")

(In Swedish)

SKB, 1985, Stockholm

- 3-6 **Transportsystem för använt bränsle  
Slutlig säkerhetsrapport**  
("Transportation system for spent nuclear fuel, final safety report")

(In Swedish)

SKBF, March 1982, Stockholm

- 3-7 Same as ref 1-5

- 3-8 **Kärnkraftens slutsteg  
Alternativa tidplaner för hantering av använt kärnbränsle. Konsekvenser för planering, säkerhet och kostnader.**  
("Alternative timetables for management of spent nuclear fuel. Consequences for planning, safety and costs").

(In Swedish)

SKB, December 1985, Stockholm

- 3-9 **Kärnkraftens slutsteg  
Technology and costs for decommissioning a Swedish nuclear power plant.**  
May 1986

(In Swedish)

SKB, Stockholm

- 3-10 **KASAM, Statens Kärnbränslenämnd:  
Etik och Kärnavfall  
Rapport från ett seminarium**  
("KASAM, National Board for Spent Nuclear Fuel:  
Ethics and Nuclear Waste, report from a seminar")

(In Swedish)

SKN Report 28, March 1988, Stockholm

## Chapter 4

- 4-1 Same as ref 1-5.

- 4-2 Same as ref 1-7.

- 4-3 **Handling and final disposal of nuclear waste  
Alternative disposal methods**

Background report to R&D Programme 86.

SKB, September 1986, Stockholm

## Chapter 6

- 6-1 **Methodology and Technology of Decommissioning Nuclear Facilities**  
1986

IAEA Technical Report Series No. 267 IAEA, Vienna

- 6-2 Same as ref 3-9.

- 6-3 **Rivning av svenska kärnkraftverk – En analys mot bakgrund av riksdagens beslut om riktlinjer för inledningen av kärnkraftsavvecklingen**  
("Decommissioning of Swedish nuclear power plants – an analysis against the background of the Parliament's decision on guidelines for the commencement of the nuclear power phase-out")

April 1989

(In Swedish)

SKB Work Report AR 89-07, Stockholm

- 6-4 **The Community's research and development programme on decommissioning of nuclear installations**  
1989

Fourth annual progress report 1988, EUR 11715, Commission of the European Communities.

- 6-5 **Huber B**  
July 1989

EC starts new research programme, Nuclear Engineering International.

# APPENDIX

## Short Overview of some Legal Requirements on the Nuclear Power Utilities with Respect to Nuclear Waste Management

The Government and the Swedish Parliament have, in various contexts, formulated society's demands on the assignment of responsibility by the nuclear power plant owners for management of the nuclear waste. A brief summary of the most important provisions of laws, ordinances etc of relevance for the R&D-programme is provided in the following.

*The Act on Nuclear Activities* (SFS 1984:3) regulates the obligations of the nuclear power plant owners with respect to management and disposal of radioactive waste. These obligations are set forth in Section 10-12 of the Act:

### “General obligations of licence-holders

Section 10. The holder of a licence for nuclear activity shall ensure that the necessary measures are taken in order to

1. maintain safety, with due consideration to the nature of the activity and the conditions under which it is carried out;
2. safely handle and finally dispose of nuclear waste, of non-recycled nuclear material arising in the activity; and
3. decommission and dismantle in a safe manner plants in which the activity is no longer to be carried out.

Section 11. The holder of a licence to possess or operate a nuclear power reactor shall, in addition to the requirements laid down in Section 10, ensure that such comprehensive research and development work is conducted as is needed in order to meet the requirements set forth in Section 10, subsections 2 and 3.

Section 12. The holder of a licence to possess or operate a nuclear power reactor shall, in consultation with other reactor possessors, prepare or have prepared a programme for the comprehensive research and development work and the other measures stipulated in Section 10, subsections 2 and 3, and in Section 11. The programme shall present a survey of all measures that may be necessary and also specify the measures that are intended to be taken within a period of at least six years. The programme shall, beginning in 1986, be submitted to the Government or the authority designated by the Government every third year for examination and evaluation.”

Sections 11-12 state that the research and development work shall be comprehensive, ie shall pertain to all links in the chain, and shall also include reporting and follow-up of alternative methods. *In the special ar-*

*gumentation on the Act* (Gov bill 1983/84:60), it is stated that the purpose of the provision concerning comprehensiveness

“is that no commitment shall be made to a given handling and disposal method until sufficient knowledge has been obtained to fully grasp and assess the existing safety and radiation protection problems. If a new and better method emerges during the continued work, this should instead be chosen”.

*In the Ordinance on nuclear activities* (SFS-1984:14), the following is set forth in Sections 25-26:

“Section 25. The programme referred to in Section 12 of the Act (1984:3) on Nuclear Activities shall be submitted to the National Board for Spent Nuclear Fuel for scrutiny and evaluation no later than September every third year beginning in 1986.

Section 26. The National Board for Spent Nuclear Fuel shall, no later than six months after the deadline stipulated in Section 25, submit to the Government the documents in the matter, together with its own statement of comment on the programme referred to there.

The statement of comment shall include a scrutiny and evaluation of the programme as regards

1. planned research and development activities,
2. reported research results,
3. alternative handling and disposal methods, and
4. the measures intended to be taken.”

The research plan reported shall thus also include an account of results achieved.

The State's view on the R&D-programme has been further expanded on in the “*guidelines for the 1986 review of the programme of measures with respect to spent nuclear fuel etc ....*” issued by the Government on December 12, 1985. These guidelines state, among other things: “During the six-year period (1987-1992), the current phase of bedrock investigations – which are of a fundamental technical-scientific nature and are not aimed at site selection – shall be completed and preparations made for subsequent phases of field investigations. The current phase, which belongs to the 1980s, must not involve any commitments to specific methods or sites for future final repositories. It should be evident from the statement of comment which additional bedrock investigations are intended to be carried out during the 1980s and which sites are concerned.

In the next phase, ie mainly during the 1990s, it is to be expected that further site investigations will also ser-

ve as a basis for the gradual narrowing-down of suitable candidate sites for future final repositories. The statement of comment on the research and development programme in this part should include a proposal for a total programme for further test drillings and broadened site investigations based on the results obtained from the current test drillings. The review statement should shed light on an appropriate procedure for how the government authorities will make a decision in site selection questions on the basis of experience gained, results of the bedrock investigations and other parts of the research and development programme etc. Furthermore, a proposal should be presented on how information and public relations should be handled at the concerned localities and who should be responsible for this.”

As is evident from the text, the above guidelines are aimed primarily at the National Board for Spent Nuclear Fuel, which is responsible for the review of the R&D-programme. In the preparation of the programme, however, the Government’s guidelines have been taken into account.

The following is stated in the Government resolution of November 26, 1987, concerning “Programme for research etc with regard to the treatment and disposal of nuclear power waste”:

“The Government finds that R&D-Programme 86 fulfils the requirements made in Section 12 of the Act on Nuclear Activities.

The Government finds that the research and development work should in the main be conducted in accordance with the principles and timetables indicated in the programme. The viewpoints expressed by the National Board for Spent Nuclear Fuel in its statement of comment on the programme should be taken into account wherever possible.

As is evident from the drafted memorandum, there is no support in the constitution for instructing the National Board for Spent Nuclear Fuel to promulgate regulations of a normative nature regarding the R&D-programme. On the other hand, in its capacity as a regulatory authority, the Board may adopt various measures under the provisions of the Act on Nuclear Activities and the Act (1981:669) on the financing of future expenses for spent nuclear fuel etc. The Board can also issue general advice.

---

The Government resolves that R&D-Programme 86 be adopted.

The Government declines to act on the National Board for Spent Nuclear Fuel’s petition for the right to promulgate regulations.”

# **Handling and Final Disposal of Nuclear Waste.**

**Programme for Research, Development  
and other Measures.**

**Part II Programme 1990-1995**

# CONTENTS PART II

	Page
<b>1</b>	<b>GENERAL</b> <b>65</b>
<b>2</b>	<b>SITING OF FINAL REPOSITORY FOR SPENT FUEL AND OTHER LONG-LIVED WASTE</b> <b>67</b>
2.1	Background 67
2.2	Factors that Influence Siting 67
2.3	Plan for Siting 68
2.3.1	Candidate Sites 68
2.3.2	Site Characterization 69
2.4	Plan for Reporting to the Regulatory Authorities 70
2.4.1	Candidates for Detailed Characterization 70
2.4.2	Plan for Pre-investigations 70
2.4.3	Sites for Detailed Characterization 70
2.4.4	Plan for Detailed Characterization 71
2.4.5	Execution of Detailed Characterization 71
2.4.6	Siting Application 71
2.4.7	Permit for Start of Construction 71
2.5	The Geological Basis 71
2.5.1	General 71
2.5.2	Pre-investigations 72
2.5.3	Detailed Characterization 72
<b>3</b>	<b>SAFETY ASSESSMENTS</b> <b>73</b>
3.1	General 73
3.2	Goals 74
3.2.1	The Overall Timetable and the Role of the Safety Assessments 74
3.2.2	Method Development 75
3.2.3	Goals for the Period 1990–1995 75
3.3	State of the Art 75
3.3.1	Scenarios 75
3.3.2	Models and Couplings 76
3.3.3	Site-specific Databases 78
3.3.4	Criteria and Regulatory Requirements 78
3.3.5	Confidence 79
3.4	Programme 79
3.4.1	1990–1992 79
3.4.2	1993–1995 81
<b>4</b>	<b>REPOSITORY DESIGN</b> <b>83</b>
4.1	General 83
4.2	Goal 84
4.3	Alternative Designs 84
4.3.1	WP-Cave Design 84
4.3.2	Deep Boreholes, Design 85
4.3.3	Construction Methods 86
4.4	Comparison of Alternative 87
4.4.1	WP-Cave 87
4.4.2	Deep Holes 88
4.4.3	Miscellaneous 88
4.5	Research Programme 1990–1995 88

	Page
<b>5</b>	<b>ENGINEERED BARRIERS</b> <b>89</b>
5.1	Waste Forms 89
5.1.1	Goals of the R&D Activities 89
5.1.2	Present-day State of Knowledge 89
5.1.3	Important Review Comments from R&D- Programme 86 92
5.1.4	Research Programme 1990–1995 92
5.2	Canister 95
5.2.1	Goal of the R&D Activities 95
5.2.2	Present-day State of Knowledge 95
5.2.3	Important Review Comments from R&D- Programme 86 96
5.2.4	Research Programme 1990–1995 96
5.3	Buffer and Backfill 97
5.3.1	Background 97
5.3.2	Goal of the R&D Activities 97
5.3.3	Present-day State of Knowledge 97
5.3.3.1	Long-term Stability of the Bentonite 97
5.3.3.2	Chemical Conditioning, Mixing with Crushed Rock etc 98
5.3.3.3	Rheology, Water Absorption, Resistance to Erosion 99
5.3.3.4	Effects of Gas 99
5.3.3.5	Sealing Measures in Boreholes and Shafts 100
5.3.3.6	Model Development for the Barrier Function 100
5.3.3.7	QA Programme 100
5.3.3.8	Summary of Research Results 100
5.3.4	Research Programme 1990–1995 102
<b>6</b>	<b>PROPERTIES OF THE ROCK</b> <b>103</b>
6.1	General 103
6.1.1	The Role of the Rock in the Final Repository 103
6.1.2	Investigation of Rock 103
6.2	Groundwater Movements in the Rock 104
6.2.1	Goals of the R&D Activities 1990–1995 104
6.2.2	Present-day State of Knowledge 105
6.2.2.1	Observation Methods for Ground- water in Rock 105
6.2.2.2	Conceptual Models 110
6.2.2.3	Validation of Models for Groundwater Movements 114
6.2.2.4	Some Special Research Areas 115
6.2.3	Research Programme 1990–1995 116
6.3	Stability of the Rock 118
6.3.1	Goals of the R&D Activities 1990–1995 118
6.3.2	Present-day State of Knowledge 118
6.3.2.1	Tectonic Processes 118
6.3.2.2	Climatic Processes 119
6.3.2.3	The Impact of the Repository on Mechanical Stability 119
6.3.2.4	Post-glacial Movements 120
6.3.2.5	Modelling of the Rock Mass 122
6.3.2.6	Experience of Earthquakes 123
6.3.2.7	Studies in Southeastern Sweden 123

	Page	
6.3.3	Research Programme 1990–1995	124
6.3.3.1	State-of-the-art Knowledge Review of Ice Ages and Land Uplift	124
6.3.3.2	Deepened Tectonic Analysis	124
6.3.3.3	Conclusion of the Lansjärv Project	125
6.3.3.4	Operation and Analysis of Seismic Data	125
6.3.3.5	International Projects	125
<b>7</b>	<b>CHEMISTRY</b>	<b>127</b>
7.1	Groundwater Chemistry and Geochemistry	127
7.1.1	Goals of the R&D Activities	127
7.1.2	Present-day State of Knowledge	127
7.1.3	Research Programme 1990–1995	130
7.2	Radionuclide Chemistry	131
7.2.1	Goals of the R&D Activities	131
7.2.2	Present-day State of Knowledge	131
7.2.3	Research Programme 1990–1995	134
7.3	Chemical Transport and Validation of Transport Models	135
7.3.1	Goals of the R&D Activities	135
7.3.2	Present-day State of Knowledge	135
7.3.3	Research Programme 1990–1995	137
<b>8</b>	<b>METHOD AND INSTRUMENT DEVELOPMENT</b>	<b>139</b>
8.1	Goals of the R&D Activities	139
8.2	Present-day State of Knowledge	139
8.2.1	Measuring Methods and Instruments for Surface Investigations	139
8.2.2	Measuring Methods and Instruments for Investigations in Boreholes	140
8.2.2.1	Drilling	140
8.2.2.2	Mapping of Drill Core and Borehole	140
8.2.2.3	Geophysical Measurements in Boreholes	141
8.2.2.4	Geohydrological Measurements in Boreholes	142
8.2.2.5	Hydrochemical Measurements in Boreholes	144
8.2.2.6	Rock Stress Measurements	144
8.2.2.7	Position Determinations in Boreholes	145
8.2.3	Measuring Methods and Instruments for Investigations from Tunnels and Shafts	145
8.3	Research Programme 1990–1995	147
8.3.1	Geological Measuring Methods and Instruments	147
8.3.2	Geophysical Measuring Methods and Instruments Radar	147
8.3.3	Geohydrological Measuring Methods and Instruments	148
8.3.4	Chemical Measuring Methods and Instruments	148
8.3.5	Rock Mechanics Measuring Methods and Instruments	149

	Page	
<b>9</b>	<b>HARD ROCK LABORATORY</b>	<b>151</b>
9.1	Background and Motives for Construction of the Hard Rock Laboratory	151
9.2	Siting and Layout of the Hard Rock Laboratory	152
9.3	Goal and timetable	153
9.4	Investigations Performed in the Pre-investigation Phase	154
9.5	Programme for the Construction Phase	156
9.5.1	Geological Investigations	156
9.5.2	Geohydrological Investigations	157
9.5.3	Geohydrochemical Investigations	157
9.6	Preliminary Programme for the Operating Phase	158
9.7	Further Information	158
<b>10</b>	<b>THE STRIPA PROJECT</b>	<b>159</b>
10.1	Goals and Results Obtained Thus Far	159
10.1.1	Brief Summary of Results from Phase 1	159
10.1.2	Brief Summary of Results from Phase 2	159
10.1.3	Goals of Phase 3	160
10.2	Present-day State of Project and Research Programme 1990–1992	160
10.2.1	“Site Characterization and Validation”	161
10.2.2	“Improvement of Site Assessment Concepts and Methods”	162
10.2.3	“Sealing of Fracture Rock”	163
<b>11</b>	<b>NATURAL ANALOGUES</b>	<b>165</b>
11.1	General	165
11.2	Poços de Caldas	165
11.3	Cigar Lake	167
<b>12</b>	<b>BIOSPHERE STUDIES</b>	<b>169</b>
12.1	The Importance of the Biosphere Studies for the Final Disposal of Nuclear Waste	169
12.2	Goals	169
12.3	Present-day State of Knowledge	169
12.3.1	Evolution of the Biosphere	169
12.3.2	Transport Pathways between Rock and Man	170
12.3.3	Other Research on the Biosphere	170
12.4	Research Programme 1990–1995	170
12.4.1	Changes in the Biosphere	170
12.4.2	Transport Pathways in the Biosphere	170
12.4.3	Models and Data	170
12.4.4	Site-specific Studies	170
12.4.5	Acceptance Criteria	171
<b>13</b>	<b>INTERNATIONAL COOPERATION</b>	<b>173</b>
13.1	Foreign R&D of Importance for SKB’s Programme	173
13.2	SKB’s Cooperation Agreements with Foreign Organizations	176
13.3	The JSS Project – Results	176
13.4	Cooperation with AECL Regarding Underground Research Laboratory	177
13.5	Fuel Leaching – Workshops	177
13.6	HYDROCOIN	177
13.7	INTRAVAL	177
13.8	Cooperation with TVO, Finland	177



	Page	
13.9	Cooperation with CEA, France	178
13.9.1	Clay	178
13.9.2	Chemistry	178
13.10	Cooperation with EURATOM, EC	178
13.10.1	COCO	178
13.10.2	CHEMVAL	178
13.11	Cooperation within OECD Nuclear Energy Agency	178
13.11.1	RWMC	178
13.11.2	TDB	179
13.12	Cooperation within IAEA	179
<b>References</b>		<b>181</b>

# 1 GENERAL

SKB's R&D-Programme 89 constitutes the 1989 plan for research and development as required in Section 12 of the Act on Nuclear Activities. The plan describes the R&D activities that are deemed necessary in order to manage and dispose of the Swedish nuclear waste in a safe manner. This Part II of the programme presents the research and development to be carried out over the next six years. Chapter 2 describes the activities aimed at siting of a final repository for long-lived waste. This chapter also provides an overview of the total programme, since many activities are chronologically linked to the siting plan. Chapter 3 deals with safety assessments. Activities that relate to the design of the repository and the engineered barriers are then described. Studies pertaining to the properties of the rock, chemical conditions and the method and instrument development that is required for these studies are dealt with in Chapters 6, 7 and 8.

The work within the major projects Stripa, Hard Rock Laboratory and natural analogues is described in separate chapters. Then follow chapters concerned with biosphere studies and international cooperation. A detailed programme for the Hard Rock Laboratory is presented in a separate background report.

The overall plans for the management of the radioactive waste from the Swedish nuclear power plants are presented in Part I of the programme.

As far as the spent fuel is concerned, the plans are largely the same as presented in R&D-Programme 86, which means that the start of construction of the final repository will be in the year 2010. The time schedule for site investigations and siting application has, however, been delayed a couple of years in order to synchronize it better with the construction of the Hard Rock Laboratory. The start of detailed characterization is now planned for 1995/96 and the siting application for 2003.

The present-day state of knowledge is presented within each subject area, with an emphasis on results obtained in recent years since the KBS-3 Report. The specific goals of the research within the area are also described, along with how these goals relate to the stage goals of the programme. Some of the most important review comments on R&D-Programme 86 are presented, along with how they have been taken into account. Finally, the planned research for the period 1990–1995 is described. For a detailed presentation of

the review comments on R&D-Programme 86, the reader is referred to a separate background report, which also contains certain comments by SKB.

As a support for the siting of the final repository and for the continued prioritization of the research work, SKB will carry out a new safety assessment by 1991 called SKB 91. The outline of this safety assessment is presented in Chapter 3.

The studies of different alternative repository systems will gradually be focussed. Different feasible alternatives were described in a background report to R&D-Programme 86. The alternatives with the highest priority are still being studied within the framework of the ongoing programme. Special studies are being conducted on certain basic designs, the results of which will be reported separately. One example is the study of the WP-Cave design, which is described in brief in Chapter 4. Priorities will be assigned to different alternatives on the basis of such studies. Important grounds for making these judgements are:

- radiological safety,
- feasibility with reference to existing or easily available technology,
- development potential,
- costs,
- uncertainties in data and models and confidence in the quality of the assessment.

Prioritization of the research work will take place internally within SKB after consultation with reference groups, experts and other concerned persons. This will be described in reports and in connection with the R&D-programmes every third year.

Execution of R&D-Programme 89 is described in Part I Chapter 5. In order for the R&D work to be effective, its planning must be continuously adjusted in response to the results obtained. SKB intends to make the necessary adjustments within the framework of the intentions of the R&D-programme.

Planned activities relating to the decommissioning of nuclear power plants are described in Part I Chapter 6. Work in this area will be relatively limited during the period 1990–1995.

Planned information and public relations efforts aimed at the general public in conjunction with the research programme and the siting process are not dealt with in this report.

## 2 SITING OF FINAL REPOSITORY FOR SPENT FUEL AND OTHER LONG-LIVED WASTE

### 2.1 BACKGROUND

The siting of the final repository for spent nuclear fuel and other long-lived waste is one of the most important problems to be solved during the 1990s for the Swedish nuclear waste programme. This question is dealt with superficially in R&D-Programme 86 /2-1/. One reason for this was that SKN had appointed a "site selection group" with the task of coming up with a proposal on how the siting question should be dealt with. A report from this group was included as an appendix to SKN's review report /2-2/ on R&D-Programme 86 and it constituted the basis for SKN's viewpoints on SKB's programme in this question.

The viewpoints offered by SKN called for a successive narrowing-down of possible sites through a geologically based screening procedure in three phases: Test phase, selection phase and licensing phase. During the test phase, a relatively large number of areas judged particularly suitable for the siting of a final repository would be screened out. Concerned municipalities and county administrations should be notified and asked to set aside the specific identified areas in their comprehensive development plans. Such plans are to be drawn up for all municipalities in the country prior to June 30, 1990. During the subsequent selection phase, the field studies would continue and those sites that are best suited for a safe final repository would be selected. On the basis of proposals received from SKB and after circulation of these proposals for comment, SKN would then judge whether a "national interest" exists under the terms of the Natural Resources Act and would notify the concerned municipalities and county administrations that this is the case. The designation of a "national interest" means that the land areas in question must be set aside for a specific type of facility, in this case a final repository, and may not be utilized for any other purpose.

A Government resolution passed in December 1987 stated that R&D-Programme 86 meets the requirements of the Act on Nuclear Activities and should serve as a basis for the continued work, and that SKN's review comments should be taken into account wherever possible. SKB has carefully considered the viewpoints put forth by SKN and found that the procedure proposed by SKN cannot be followed in all respects. Successively screening out a diminishing number of sites from a large number of original candidates requires that a relatively large number of municipalities set aside land in their planning work for the sites that have been screened out. These areas shall be held in reserve pending the

necessary investigations and siting decisions. The procedure can lead unnecessarily to troublesome and drawn-out political debates in many municipalities.

As was pointed out in R&D-Programme 86, the large body of material from geological field surveys shows that there are many sites in Sweden suitable for the siting of a final repository from the geological point of view. This means that other factors can be accorded greater importance in the selection of a site. It is doubtful whether the best site in all respects can be identified with reasonable efforts. Nor is this necessary; it is quite sufficient to find a site where the rock possesses such characteristics and where conditions otherwise are such that a very high standard of safety and radiation protection can be met. In SKB's view, there is no reason to demand a more detailed selection process than demonstrating with general data that there are no obviously more suitable areas than those finally proposed.

The important, technically detailed evaluation of whether a site is adequate for constructing a final repository that meets the very high demands on safety will be made in connection with the review of the siting application. This evaluation cannot be performed until site-specific data and a site-adapted design are available.

### 2.2 FACTORS THAT INFLUENCE SITING

The siting of a final repository must take into account a large number of factors. As already noted, the research conducted to date shows that there are many sites in Sweden that meet the requirements that can be made on the geology at a final repository. Siting should therefore also take into account other factors that are not of direct safety-related importance. Table 2-1 presents some of the most important factors.

The parameters in the table have been divided into four groups. Groups I and II are primarily of importance for the long-term safety of the repository. Group III parameters are primarily important for the construction and operation of the repository and for associated safety aspects, as well as from the economic and social viewpoints, while group IV parameters are of social and political importance. In the siting process, priority will be given to meeting fundamental requirements with regard to the parameters in groups I and II. An optimal balance of the parameters in groups III and IV will then be sought.

**Table 2-1. Parameters of importance for siting of a final repository.**

I	Geology Topography Geohydrology Geochemistry	III	Transportation Infrastructure Land value Existing buildings Population density	IV	Land owners Public opinion
II	Biosphere Recipients		Agriculture Fishing Military interests Cultural-historical interests Archaeology Cultural-geographical interests Nature conservation Flora Fauna Recreation		

The selected site must offer such conditions with regard to geology etc that a repository can be built that fulfils the high safety-related requirements. According to the results of previously conducted studies, the fundamental requirements on the site are above all:

- low groundwater flow,
- favourable groundwater chemistry.

Sites with a relatively flat topography are sought after as candidate sites. This ensures a low driving force for groundwater flow (low gradient), which is an advantage. Furthermore, regional zones of movement in the bedrock are avoided. The size of the site, the surface area between the regional lineaments, must be ample in order to provide margins. A bedrock that simplifies interpretation of the investigation results is preferable. Areas with potentially workable ore reserves are to be avoided.

## 2.3 PLAN FOR SITING

### 2.3.1 Candidate Sites

On the basis of the above considerations, SKB has formulated a plan for the siting of the final repository for spent fuel. The main features of the plan are illustrated in Figure 2-1. Its intention is to systematically tie together the collection of site-specific data, the required decisions, information and public relations activities within SKB and the required regulatory review and licensing procedures.

The inventory of possible sites that has been in progress more or less continuously since the early 1980s will be concluded by 1991. Furthermore, certain geo-

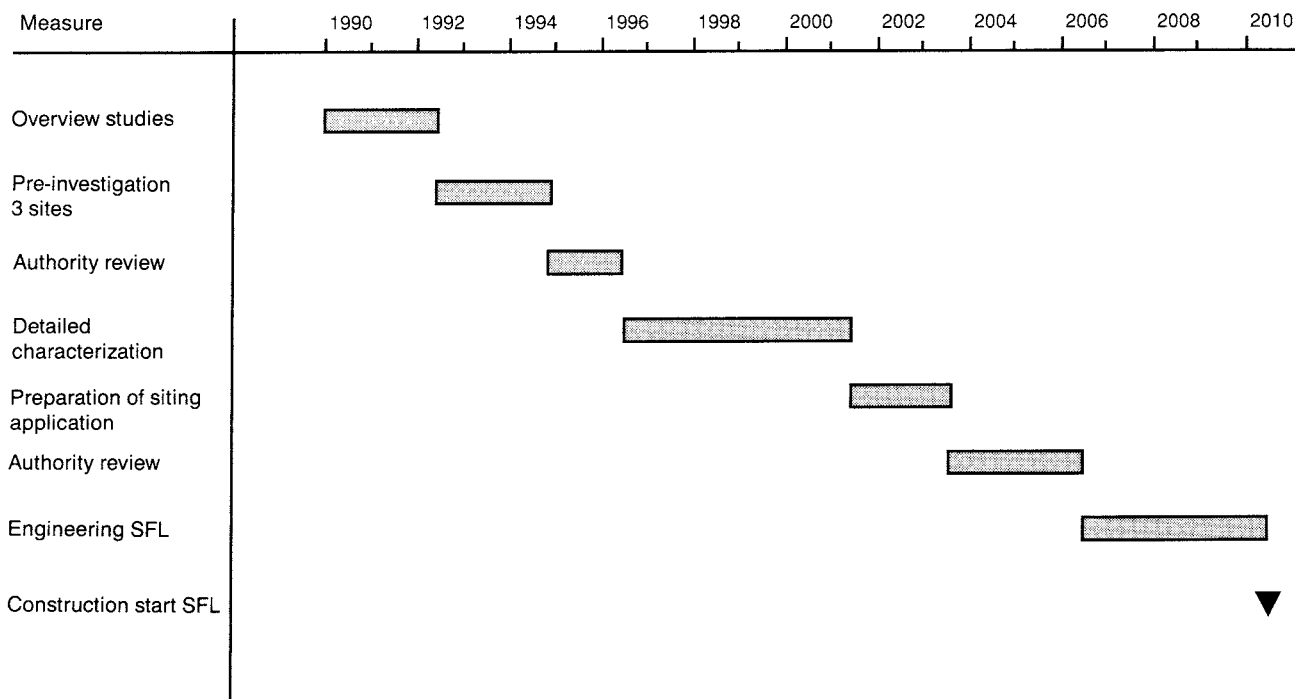

Figure 2-1. Overall timetable for siting of final repository for spent fuel (SFL).

logical overview studies will be carried out on the basis of currently existing geological material. These supplementary studies are of a general nature and do not require any further drilling or borehole measurements.

A new safety assessment called SKB 91 is expected to be finished in 1991. One of the purposes of this assessment is to evaluate, more thoroughly and systematically than before, the importance of variations in geological conditions for the function and safety of the final repository. The KBS-3 Report /2-3/ claimed that: "The analyses show that even sites such as Finnsjön, with higher groundwater flows than those mentioned (Gideå and Kamlunge, and probably also Fjällveden), should be acceptable from the safety viewpoint." In SKB 91 this will be further backed-up on the basis of experience gained since 1983 when KBS-3 was written. A more detailed plan for SKB 91 is provided in Chapter 3.

On the basis of the experience obtained from investigations of study sites, from Stripa and from the work at Simpevarp for the Hard Rock Laboratory, a programme for pre-investigations of candidate sites will be prepared. Since knowledge of the geology of the candidate sites can vary a great deal, the programme will stipulate which investigations are to be carried out on the different sites and how they are to be coordinated. The programme will be prepared in the beginning of 1991 in order to draw maximum benefit from experience from the Hard Rock Laboratory.

During 1992, SKB intends to announce three sites which SKB considers to be suitable candidates for the siting of the final repository. The candidate sites will be chosen on the basis of the factors mentioned in the above section 2.2. Site selection should furthermore be made so that social services, communications and competent labour will be available. The fundamental requirement qualifying a site as a candidate site is that it should offer good potential for achieving a repository with high safety.

At this point, the site data will be of a general nature and must be augmented by pre-investigations and subsequently also detailed characterization. The purpose, however, is to be able to concentrate continued geostudies, licensing questions and information activities to a few promising areas. As a basis for the selection of candidate sites, the results of the above-mentioned studies and a summary of existing data on the three sites will be presented at the same time. In connection with this announcement, SKB's information on matters of special interest for the siting of a final repository will be intensified.

An important part of the work is to plan and execute objective and open information activities aimed at landowners, nearby residents, the municipality, authorities etc.

### 2.3.2 Site Characterization

After the candidate sites have been announced, an iterative process of site-specific investigations, compilations and evaluations of results and planning of possible further studies will begin. This will lead to a gradual increase in the amount of data available for assessing the suitability of the candidate sites, for positioning the repository within a site, for determining possible tunnel routes and waste emplacement positions, for positioning of sealing plugs etc. On the finally selected repository site, the process will extend all the way up to sealing of the final repository.

The increasing amount of detailed information will gradually require greater intrusions on the sites in the form of shafts/tunnels to the relevant repository depth and tunnel/boreholes in the available deposition volume. It is therefore essential that the investigations be planned and executed with a view towards their effects on a repository.

After permission has been obtained from the landowner, pre-investigations will be conducted during the years 1992-94 on the three sites according to the above programme. SKB 91 will be supplemented with site-specific information to provide a basis for a preliminary assessment of the long-term safety of a final repository located on each of the three sites. At the same time, the analysis of the parameters of importance for the siting will be augmented and deepened.

A general programme for detailed characterization of the candidate sites will be prepared in 1994. The programme will be based on the experience gained during the construction of the Hard Rock Laboratory and the experimental programme conducted in conjunction therewith. Furthermore, a preliminary environmental impact statement will be prepared for each of the three sites. The primary purpose of this environmental impact statement is to give an account of the effects of conducting detailed characterization. It can only provide a very general description of the impact of a final repository on the site in question.

Pre-investigation results, a programme for detailed characterization, a preliminary safety assessment and environmental impact statements will be submitted to the concerned authorities at the end of 1994. The concerned authorities are primarily SKN, the municipality and the county administration. SKI, SSI and other agencies can be expected to serve as reviewing bodies for the aforementioned authorities. After a review period of about 18 months, it is estimated that the necessary approvals and permits for detailed characterization may be available in early 1996. Such characterization will then start on one site, and on a second site in 1997. The detailed characterization will be carried out in appropriate stages. A site-specific programme for the

detailed characterization and their subdivision into stages will be prepared during 1995/96. It will be based on experience from the Hard Rock Laboratory and from the pre-investigations of the candidate sites.

A rough layout of the area required for a final repository will be needed as a basis for starting detailed characterization. A conceptual design of the final repository system must therefore be chosen in 1995. A summary of completed studies of different alternatives and of then-existing knowledge concerning the components in the barrier system will be submitted in connection with this. It is assumed that this can be done in connection with R&D-Programme 95. During the years 1995-98, the necessary supplementary studies for the components in the selected conceptual design will be carried out, and the models required for an optimization of the final repository to the site that is finally selected will be further developed and verified. The optimization will be carried out in parallel with a second stage of the detailed characterization. These activities are expected to be completed by 2001, when work will begin on preparing a siting application under the Natural Resources Act and under the Act on Nuclear Activities. The application, which should preferably be finished by 2003, will contain a preliminary safety report with a detailed assessment of the long-term safety of the final repository. It is assumed that the application will take three years to process, which would mean that a Government-approved site will exist in 2006.

After the site has been approved, engineering drawings will be prepared and an updating of the safety report will be carried out, particularly with respect to safety during the operating (deposition, surveillance) phase. It is estimated that this report will be finished in 2008 and will comprise the basis for SKI's and other authorities' approval of the start of construction in 2010.

SKB's goal throughout the siting phase is that experience from R&D activities shall be systematically exploited and that the safety-related importance of the obtained information shall be successively evaluated. On the basis of this evaluation, critical parameters and conditions will also be identified as a basis for R&D prioritization.

## **2.4 PLAN FOR REPORTING TO THE REGULATORY AUTHORITIES**

The purpose and essential aspects of the safety-related review expected to be conducted by the regulatory authorities in conjunction with the siting plan are discussed below.

### **2.4.1 Candidates for Detailed Characterization**

The role of the regulatory authorities in this phase is linked to the general review of the R&D-programme carried out by SKN. This review is expected to be aimed primarily at establishing the acceptability of SKB's judgement – that a concentration of efforts, as regards both geological studies and information, is desirable and possible according to the reported planning, without unnecessarily limiting the potential for successful siting.

### **2.4.2 Plan for Pre-investigations**

In preparation for the pre-investigations, SKB will, as has already been mentioned, prepare a plan for their execution. The plan will also contain a discussion of what possible impact the planned investigations might have on the properties of the rock that are of importance for the safety of the final repository. The regulatory authorities are expected to review this plan.

### **2.4.3 Sites for Detailed Characterization**

Around 1994, the pre-investigations will have yielded a new site-specific database that will permit a deeper evaluation of the potential of the sites as repository sites.

Based on the SKB 91 safety assessment, variation analyses will be carried out in order to determine the safety-related importance of differences between the sites. The information from this investigation phase will primarily be applicable to the safety assessment's far-field description, for example locations of major zones, available space between zones of weakness and the large-scale gradient over potential deposition areas. Certain statistical information on the distribution of hydraulic conductivity on the investigated site will also be available, as well as data on groundwater chemistry.

Providing no major unfavourable factors emerge, two of the studied sites will be designated as sites for detailed geological characterization. If several sites should turn out to be inappropriate for further characterization, it may be necessary to designate more candidates, resulting in a delay in the schedules. SKB judges the risk of this to be small.

Besides making a preliminary safety assessment and preparing preliminary layouts, SKB will also assess environmental impact during the detailed characterization and construction of the final repository. Safety assessment, environmental impact studies and planning of continued detailed characterization require that alter-

native repository designs be tried out on the candidate sites. Furthermore, other types of social impact on the municipalities where the candidate sites are located will be evaluated.

The regulatory authorities are expected to review the safety relevance of the variation analyses and make sure that SKB has made a reasonable interpretation of the site-specific information. The detailed characterization will require considerable financial and human resources, as well as building permission from the municipality in a certain phase. This means that SKN and other concerned central, regional and local authorities must approve the start of the detailed characterization.

#### **2.4.4 Plan for Detailed Characterization**

The detailed characterization will be based on site-specific plans stipulating how the investigations are to be conducted. These plans will in turn be developed on the basis of the general programme for detailed characterization prepared in 1994, on continuously received site-specific information and on experience from the Hard Rock Laboratory. The effect of the investigations on a future repository is an important question here, especially the future importance of the location of the shaft or tunnel down to repository depth. Other questions that will be taken up are the strategy for characterization of the rock mass, which parameters are to be measured and the measuring methods that are to be used. A large body of experience will have been obtained from the Hard Rock Laboratory, for example. The authorities are expected to review this material.

#### **2.4.5 Execution of Detailed Characterization**

The studies will probably be divided into stages, with the option of interrupting if it should turn out that a site is unsuitable.

During 1996–1999, the site characterization will greatly increase the availability of site-specific data. On the basis of these data, it should be possible to sketch in a probable repository geometry with levels, tunnel directions and deposition areas. On the basis of the geohydrological variability in the potential deposition areas, it should be possible to establish space requirements and a near-field-specific database.

SKB assumes that an important part of the regulatory review will consist of continuous follow-up of this work.

#### **2.4.6 Siting Application**

The siting application intended to be submitted in 2003, and primarily intended to cover a single site, will include a preliminary safety report with an emphasis on the long-term safety of the final repository. The safety assessment will be based on the results of the detailed site characterization and the site-optimized final repository

system. This application will be considered under the Act on Nuclear Activities as far as its radiological safety aspects are concerned. The siting application will also include a description of measuring methods and assessment grounds for determining the local quality of the rock as the excavation of the deposition tunnels progresses, as well as for positioning the deposition holes in relation to this. The application in its entirety will be considered under the Natural Resources Act, the Environmental Protection Act, the Planning and Building Act etc.

#### **2.4.7 Permit for Start of Construction**

The safety report will be updated well in advance of the planned start of construction. This updating will primarily be concerned with safety in connection with transport, handling, encapsulation, deposition etc of the waste. The report may also update the preliminary assessment of long-term safety. This report should also be reviewed under the Act on Nuclear Activities.

The final account of the repository's long-term safety will in all probability not be submitted before the application for permission to seal the repository. This does not mean that the requirements on the accounts to be submitted in connection with the siting application and on any subsequent occasions are in any way less rigorous than for a final account. In other words, the word "preliminary" should not be misinterpreted.

## **2.5 THE GEOLOGICAL BASIS**

### **2.5.1 General**

SKB has carried out extensive surveys and reconnaissances of possible sites for a final repository at different periods. Present-day data from the reconnaissances consist mainly of geological parameters of the type mentioned in section 2.2. The candidate sites shall be of such quality that it is deemed possible to demonstrate the necessary long-term safety in a siting application in the year 2003. Supplementary information such as national physical planning, municipal development plans etc. are required to find candidate sites.

Investigations performed to date have been carried out on land. However, the possibility of siting a final repository underneath the Baltic Sea should still be kept open, since such a site would have clear safety-related advantages over long spans of time. These advantages include factors such as a defined gradient for groundwater flow, low groundwater flux and postponement of the well scenario. In view of the advantages a coastal site would appear to offer, SKB plans to compile geological data for coastal candidate sites extending from the shore to about 10 km offshore.

SKB also plans to compile a body of comparative material for certain of the study-site investigations previously reported. The variations in data that exist on

these study sites shall be able to be compared with the variations analyzed in SKB 91. This will provide further support for the conclusion that there are many sites in Sweden that are suitable from a geological point of view for the location of a final repository.

Since R&D-Programme 86 was presented, certain studies have been conducted for the purpose of broadening the geological material prior to the selection of candidate sites. Sweden's morphology, bedrock and tectonics have been compiled in /2-4/. The report is primarily based on existing material. The tectonic picture has been obtained with the aid of geological maps, lineament maps based on Landsat images and relief maps. Sweden has been divided into tectonic regions and the orientation, density and length of lineaments is presented on maps.

A summary of southern Sweden's bedrock and tectonics as well as surrounding marine areas is presented in /2-5/. In addition to conventional geological material, data from a large number of prospecting surveys have also been used. Several seismic profiles from land and out over nearby marine areas are reported. The material has been compiled in a large number of maps and profiles.

The question of siting of the final repository in gabbro instead of gneiss, granite or a similar type of rock was dealt with in R&D-Programme 86. It was thereby concluded that: "Investigations already completed and general experience of gabbro show that it would probably be relatively difficult to find sufficiently large homogeneous formations among the relatively sparsely occurring gabbro massifs, in comparison with gneiss or granite." It was further stated that "The conclusion is that it is best to concentrate further geological studies on gneiss and granite. These rock types are sufficiently good and are the most likely candidates for hosting a final repository." These statements elicited some criticism from a few reviewing bodies. This criticism stated that SKB had not considered all available material regarding gabbro massifs in its assessment. In response to this criticism, SKB commissioned SGU (the Geological Survey of Sweden) to supplement its inventory of gabbro massifs. This supplementary investigation has not occasioned any change in the conclusions drawn in R&D-Programme 86.

## 2.5.2 Pre-investigations

As is evident from the above, SKB is planning to carry out the investigations for the candidate sites in a pre-investigation phase and a detailed characterization phase. SKB is currently conducting several projects with an extremely high level of ambition to develop and test technology for such investigations. These include the Hard Rock Laboratory and the Stripa Project, see further Chapters 9 and 10.

Pre-investigations shall provide material for designating which volumes are of interest for continued detailed

characterization, for making a preliminary judgement of whether the site fulfils fundamental requirements with regard to long-term safety and for alternative, preliminary repository designs.

The pre-investigations shall also provide a general characterization of the candidate site. Based on geological and geophysical surface investigations, the main rock type and major tectonic zones on the candidate site and in its environs will be documented. Boreholes will be drilled, a few to great depths, whereby rock types and fracture zones will be documented. Rock stresses will be measured to determine mechanical stability at different depths. The conductivity and groundwater flux of the rock will be measured. Representative water chemistry will be measured. Matters relating to the geometry and interconnection of zones and flowpaths will not be studied until the detailed characterization phase.

The pre-investigations shall also indicate which volumes are of interest for continued detailed characterization. Volumes judged suitable for hosting a repository shall be designated. Furthermore, those volumes that subsequently need to be characterized between the repository and discharge areas shall be defined.

The results from the pre-investigations will be utilized to plan the continuation of the detailed characterization.

The programme for pre-investigations shall describe what measures are to be carried out on the different sites by means of what methods. A general programme will be presented in 1991. For each candidate site, a site-specific programme will then be prepared and executed. Coordination with respect to various kinds of resources will be required.

## 2.5.3 Detailed Characterization

The detailed characterization shall

- confirm that a suitable repository volume is available,
- yield information for site adaptation of the access to the repository,
- provide preliminary data to guide the construction of the repository,
- provide data to permit the repository system to be optimized with respect to engineered barriers and geometric configuration,
- characterize the area to the necessary extent so that a very good body of supporting data can be presented along with the siting application.

It is assumed that detailed characterization will be conducted on two of the candidate sites, suitably staggered in time, and that the investigations will be subdivided into appropriate stages.

A general programme for detailed characterization will be presented in 1994.



# 3 SAFETY ASSESSMENTS

## 3.1 GENERAL

Nuclear activities must be conducted in an acceptable manner with respect to safety and radiation protection. The safety of the activities is assessed by means of performance and safety assessments. The performance assessments constitute studies of subsystems and their interaction, or of the special conditions under which performance is to be guaranteed. The performance studies then serve as a basis for the studies of total safety that make up the safety assessment. Besides safety level, a safety assessment shall also define the uncertainty associated with the judgements.

The purpose of the performance assessments will differ during different phases of development and licensing of a final repository. In the introductory phase, the performance of the subsystems in the repository will be evaluated. The uncertainty existing in current knowledge regarding essential functions will indicate priorities for further research and development.

In a later phase, attempts will be made to find a balance between the safety barriers, in other words the system will be optimized with respect to performance and cost at an acceptable safety level. During the licensing phase, it must be formally and finally demonstrated that the system fulfils the demands made by society on safety.

SKB's R&D-Programme is currently in a phase where the fundamental feasibility studies have been concluded. Review of alternative sitings and repository designs is currently in progress and a progressive culling of alternatives with less development potential is being carried out. In this phase, it is essential that the studies of long term performance and safety provide a basis for variation studies where the safety-related importance of the different barriers or the different designs can be assessed.

Compared with KBS-3, whose purpose was to prove feasibility, the next major integrated safety assessment, SKB 91, will, as far as is possible, reduce the safety margins in the calculations and avoid highly pessimistic simplifications. The idea is, however, still to specify a design and dimensions that meet the acceptance requirements and provide the necessary safety margins. But the higher realism will permit a more accurate quantification of the safety effect that a change in design or dimensions will entail.

In order to fulfil the above ambitions, a safety assessment must be based on:

- information on waste quantities and radioactive materials in the repository,
- a description of a reference design with materials, dimensions and quality requirements,
- a characterization of the repository site with respect to factors of importance for safety as well as their variation and uncertainty.

The performance assessments include the following elements:

- review of the external circumstances (scenarios) that can arise, and definition of which of these scenarios the repository shall be able to cope with,
- description of the processes of importance for the safety of the repository that can occur, and of the models and databases with whose help the processes can be quantified,
- estimate of the performance of the repository with respect to time for the design scenarios.

A safety assessment must also include the following elements:

- definition of society's acceptance requirements for the waste and over the relevant time spans,
- comparison between calculated consequences/probabilities and the acceptance criteria,
- analysis of the uncertainty existing in the data and models with respect to its importance for acceptance.

The degree of detail and completeness in the different elements of the assessment will vary with the state of development and the knowledge base, as well as with the specific purpose of each assessment. Goals, state of development and programmes for essential parts of the performance and safety assessments are dealt with in this chapter.

In its review of R&D-Programme 86, SKN recommended that SKB should prepare during 1988 a simple and clarifying description of methods and procedures for performance and safety assessments. SKB has underestimated the labour involved in preparing such a booklet, and the work has proceeded more slowly than expected. The material requires further work before it can be distributed to a large readership. The goal is first to compile material that is judged by experts in the field to provide a relatively good and complete description, and then to rework it to different levels of simplicity.

## 3.2 GOALS

### 3.2.1 The Overall Timetable and the Role of the Safety Assessments

R&D-Programme 86 states that the final design of the repository for spent nuclear fuel does not have to be submitted until around the year 2000. The research work shall be oriented towards furnishing adequate support material for this purpose. The general timetable for achieving this was presented in Chapter 2.

The safety assessments constitute a part of the background material for the necessary decision-making sequence within SKB and for the regulatory authorities' assessment of progress in SKB's R&D work and decisions on licensing matters. At the same time, an integrated safety assessment constitutes an important tool for judging the relevance of progress within the different research fields and for evaluating the need for additional work.

As is evident from the timetable given in Chapter 2, three sites will be proposed as candidates for a future final repository in early 1992.

The KBS-3 report stated that the bedrock at several locations in Sweden has the characteristics required for a safe final repository. The report also stated that even areas with higher groundwater flows than those analyzed in detail in KBS-3 could be acceptable. Further performance studies of different components and parts of the repository have been able to better quantify the uncertainties and the required safety margins in a number of areas. This experience has strengthened the notion that a safe repository can be built at a number of sites in the country.

To form a basis that will allow an evaluation of the safety-related importance of the geology of the repository site, an integrated safety assessment will be carried out by 1991, SKB 91. The assessment will, for a central case, be based on the geological conditions at Finnsjön, and be carried out in such a manner that the importance of changes in geological conditions can be studied through variation analyses. Compared with KBS-3, SKB 91 will utilize to a lesser extent safety margins and pessimistic simplifications to establish a given safety level. The intention is to obtain greater realism in the assessment and thereby obtain a better basis for accurate variation analyses.

Investigations will be carried out during the period 1992–1994 to determine the suitability of the three candidate sites. Their purpose is to find two sites suitable for detailed investigations. In 1994, a sufficient body of data is expected to exist to show whether the sites live up to these expectations.

These pre-investigations will supply material for site-specific variation studies in SKB 91. The variation studies constitute a part of the basis for determining whether the candidate sites are suitable for the detailed investigations.

If the authorities accept the choice, a decision can be made to conduct further detailed investigations on two sites starting in 1995. These investigations will include shaft sinking or tunnelling to provide a detailed description of the rock at repository level. It must thereby be kept in mind that the site investigations can influence the local conditions on the site. The effect of a shaft or tunnel in different locations on the site in question must be clarified, as well as how the access fits in if the site should be chosen as the repository site. Here again, much of the data will come from SKB 91 and the pre-investigations.

At the same time as the above, the Hard Rock Laboratory will be constructed starting in 1990. From the viewpoint of the safety assessment, the construction of the Hard Rock Laboratory constitutes a large-scale test of our ability to predict rock quality in depth and of the quality of our investigation methods. Models of groundwater flow will be tested in connection with the construction of the laboratory, and a considerable reinforcement of the databases for rock at repository depth is expected.

Other activities at the Hard Rock Laboratory will aim to validate or refine models of importance for the safety of the final repository in a geological environment judged to be characteristic for a future final repository. If site data or safety assessments during the 90s occasion reevaluation of the factors or processes considered to be most relevant to safety, tests in the Hard Rock Laboratory may have to be adjusted to this.

In parallel with the geoscientific investigations, alternative designs of the repository's engineered barriers and the near field will be studied during the first half of the 90s. Parameters of importance for siting must be clarified during 1994. Around 1996/1997, the studies are expected to have reached such a state of maturity that one principal design remains for final adaptation to the selected repository site.

The reference design and set of models in SKB 91 will be chosen so that they are also suitable for variation studies within the near field. The far-field portion of the assessment will, however, probably have to be modified during the period 1994/1995 with reference to how different models managed to predict the groundwater flow pattern in the Hard Rock Laboratory.

The general research will proceed throughout this period as a support for siting and system selection. Experience and information from the Hard Rock Laboratory, field investigations and other research will successively be fed into the safety assessments in the form of improved models or data.

At the same time as the site-specific optimization of a final repository is begun around 1999, the analysis sequence and thrust of the safety assessments must also be modified to meet the needs in a siting application in 2003.

Following a siting application, a building permit is expected in 2010, an operating licence in 2020 and a seal-

ing permit during the 2050s. Similar modifications and updatings of the safety account are foreseen at these times.

### 3.2.2 Method Development

In order to simplify systematic safety assessments and variation analyses, method development is currently being pursued on the national and international levels.

This development work applies to methods for:

- execution of probabilistic assessments,
- definition and evaluation of scenarios,
- validation of calculation models,
- analysis of uncertainties, sensitivity etc.

This work is of such a character that it is very difficult to assign deadlines to quantitative goals. The best available methodology will be used on each occasion. The state of the art is described in section 3.3.

In order to strengthen the SKB resources for conducting safety assessments, with associated method development, two additional persons have been hired. One focusing on nuclear transport in the near field, one on nuclear transport in the geosphere.

The purpose of SKB's efforts is to progressively refine the methods with respect to how the safety assessments will be utilized at different times. The methods shall facilitate review and create an understanding of how the analyses and assessments have been carried out. They shall, if possible, be internationally accepted.

### 3.2.3 Goals for the Period 1990–1995

In summary, the following goals apply for the work within the safety assessment field during the period 1990–1995.

The performance and safety assessments shall provide material for decisions in accordance with SKB's general timetable.

- A complete safety assessment (SKB 91) will be carried out by 1991 for a design closely related to KBS-3. The assessment will be executed in such a manner that variation analyses can easily be carried out.
- In connection with the safety assessment, variation analyses will also be carried out by 1991 of how different geological conditions influence the results of the safety assessment.
- Site-specific follow-ups of SKB 91 will be carried out by 1994 for the candidate sites identified at the beginning of 1992.
- Comparative performance assessments will be carried out by 1995 for those barrier alternatives that can be of importance for the execution of detailed geological investigations.

Method development for uncertainty studies, scenario definition, validation etc, and for presentation of

results, is intended to be pursued continuously in close international cooperation and coupled to the specific requirements made by the safety assessments in different phases of the R&D-programme.

- A systematic review of the scenarios that should be included in the safety assessment, based in large part on the work with SKB 91, will be supplemented and reported on in R&D- Programme 92.
- During the coming three-year period, QA guidelines will be prepared for, among other things, documentation, handling and storage of data, as well as for programming and documentation of computer programs.

## 3.3 STATE OF THE ART

### 3.3.1 Scenarios

Early on, repository performance assessment was divided into a scenario analysis and a consequence analysis. The scenario analysis includes both identification of possible scenarios and a description of what different scenarios mean for repository performance and the probability that they will occur. The first part of the work, identification of scenarios relevant to safety, has often been done in a relatively unstructured fashion. The goal of not overlooking any relevant scenarios imposes high demands on the ability of the methodology to identify possible events and processes in a logical manner.

Since many aspects of scenarios are global, ie independent of location and repository design, SKB has deemed it essential that development within this area be carried out in close international consultation.

In order to create a consensus on how to identify scenarios, SKB has worked actively together with SKI during 1986/87 to initiate cooperation in scenario work within OECD/NEA. Since 1987, a working group within NEA's committee for radioactive waste has dealt with these questions. Methods used by different groups in the world have been collected and systematized. The purpose is to create an international overview of available methods and discuss their advantages and disadvantages in a state-of-the-art report. A preliminary document is expected to be ready in 1990.

There are two basic ways to attack the problem of identifying a complete set of scenarios. The first is to start by defining all events or processes that can influence the safety of the repository, after which they are systematically grouped on the basis of physically reasonable causal chains or coupled phenomena with sufficiently high probability. These groups then constitute the selected scenarios. The second way is to define the scenarios directly on the basis of historical or geological experience, or on the basis of hypotheses for global or regional evolution. Then the events or processes of importance for repository performance to which the scenario gives rise are defined for each scenario.

The first method is said to entail working from the bottom up, the second working from the top down.

During 1988 and 1989, SKI and SKB have jointly tested the application of a specific bottom-up method of scenario definition developed by Sandia National Lab in the USA. The method was originally developed for salt repositories but has also been applied to a repository in basalt. In Sweden, it was applied on a KBS-3-like repository on a fictitious repository site. Experience from this project /3-31/ has shown that it is very difficult to rely solely on a bottom-up method. The choice of what to include and what not to include of the original phenomena is often based on an intuitive feeling for the scenarios to be arrived at in a later phase.

In its review of R&D-Programme 1986, SKN recommended that SKB should in particular include work with different types of intrusion, its causes and its consequences. During the work with scenarios in general, SKB has found that the handling of intrusion scenarios in the safety assessment is highly dependent on:

- whether the intrusion is regarded as intentional or unintentional,
- the degree of retrievability or reparability that is required or striven for in the repository,
- society's ability to keep information on the repository available over long periods of time,
- society's acceptance criteria for a final repository.

The above question is also influenced by how IAEA safeguards will be applied to a final repository for spent nuclear fuel. A meeting was held within IAEA on this question in September 1988.

The special status occupied by intrusion scenarios among other scenarios has also been noted within NEA. An international workshop was arranged in June 1989 by NEA on the topic "Assessment of the Risks Associated with Human Intrusion at Radioactive Waste Disposal Sites". Furthermore, SKB has proposed that the question of what demands are to be made on information preservation should be dealt with in a future Nordic collaboration to replace the one previously financed through the Nordic Council.

In view of the strong international nature of these issues and ongoing activities and plans, SKB has deemed it suitable to wait before beginning direct technical evaluations of different intrusion scenarios.

### 3.3.2 Models and Couplings

Quantified forecasts of repository performance require that the processes of importance for safety can be modelled. Calculation models for source strength, temperature effects, groundwater flux, canister penetration, release of radionuclides in the fuel, nuclide transport in the near field, groundwater pathways in the rock, groundwater transport of radionuclides, interaction of radionuclides with fracture faces and rock matrix, transport pathways to the biosphere and radio-

nuclide dispersal in the biosphere, as well as resulting doses to man, must be applied in sequence.

### Development of Calculation Models

SKB has a number of computer models available for different calculations required in a safety assessment. The status and availability of these models and their future development are shown in a catalogue of calculation models /3-2/. The catalogue includes both models to which SKB has direct access and models which SKB's consultants have used in different projects. The catalogue will be revised periodically.

In connection with the review procedure for R&D-Programme 86, several reviewers expressed a wish for an explicit strategy for how SKB intends to meet the need for and have control over the large computation programs that comprise important tools in the safety assessment. They noted that it is important that SKB should have constant access to the tools that will be developed successively over many years. Furthermore, it is urgent that the tools be collected in one or two computers so that the analyses can be performed consistently, with simple transfer of data between programs. Certain analyses and problems already require computers with immense computing power – so-called supercomputers. SKB shares the view that it is important to have the computation programs central to the safety and performance assessment collected in one computer. SKB also considers it important to have full access to the results of the development work behind the programs and not to be completely dependent on individual consultants. From the viewpoint of quality assurance, it is also important that the data processing be integrated.

Since the mid-1980s, all important data from the geoscientific investigation programmes have been collected in a database – GEOTAB. This database is stored in SKB's VAX 750 computer. This is a relatively old model, which is also overloaded at times. It cannot be used for programs that require large computing power.

In order to meet the need for large computing power, SKB has acquired its own computer, a CONVEX 210. This computer is expected to cover the need for the next few years. Its capacity can easily be upgraded if needed within the same computer family. All major computation programs will be implemented on this computer, and communication links will be established to consultants engaged for large calculations and/or program development. All programs will be entered under the UNIX operating system in order to simplify exchange with other machines. Special importance is attached to the development of an integrated transfer of data between programs used in series within an analysis.

Having an in-house calculation computer gives SKB the following advantages:

- all important calculations can be run in the same machine,
- all important programs are under SKB's control,

- SKB can request that consultants use SKB's machine,
- much larger computer simulations can be carried out within a reasonable cost frame,
- the integration of program systems permits good quality assurance of the data processing, all the way from measurement results in laboratories and on study sites to the final results included in the safety report that is to serve as the basis for the necessary permits and licences from the regulatory authorities.

### Calculation Models for Source Strength and Barriers

In view of the uncertainty existing in the forecasts of future waste quantities, present-day calculations of source strength in the spent fuel should be able to be performed with sufficient accuracy via ORIGEN 2 or CASMO/BEGAFIP. When preparing the material on which the siting application is to be based, it may be necessary to further validate the calculation models for the source term for certain transuranics around the turn of the century.

The models for canister corrosion, buffer function and fuel leaching are discussed in Chapter 5. Models for groundwater flux and movements on different scales are discussed in Chapter 6. The chemical conditions in the near field and the speciation of the radionuclides are discussed in Chapter 7. Models for radionuclide dispersal in the biosphere and the dose consequences of this are dealt with in Chapter 12.

### Calculation Models for Nuclide Transport in the Near Field

In the early 1980s, a number of models were developed to calculate the mass transport in the near field, ie from the spent fuel up to and beyond the redox front.

- Model (analytical and numerical) for one-dimensional non-steady-state transport and disintegration in the buffer.
- Model for steady-state three-dimensional transport through the buffer in through fracture openings in the rock.
- Analytical one-dimensional model for the migration of the redox front in the buffer.
- Model (analytical and numerical) for the movement of the redox front in a fracture (advective) and simultaneous diffusion into the rock matrix.
- A model for the transport of a nuclide across the redox front, including solubility-limited precipitation.

These models are still usable. Some will be further developed.

A development of coupled models for geochemistry and transport is deemed desirable. For a good description of such factors as the redox front, opening/sealing of fractures, evaluation of natural analogues etc, models that deal with more complex chemistry are required.

Such a model should include complexation, dissolution/precipitation, temperature variations and sorption.

The models previously used for eg concrete degradation in SFR and the redox front at Poços de Caldas, CHEMTRN and THCC/3-2/, are not very good at describing sharp fronts. Moreover, the computation times are very long owing to the fact that the programs are based on coupled problem design. Further development is required here.

**Geochemical equilibrium models.** The goal of geochemical modelling is to simulate nuclide release and migration out from a repository. A final repository gives rise to a temperature increase in the near field which in turn affects the groundwater and surrounding rock. A geochemical model enables these changes and their effect on the repository to be calculated. Geochemical models can also calculate how the release of radionuclides from a repository is affected by the composition of the fuel and the groundwater and by the surrounding rock.

In geochemical models, physico-chemical principles are used to interpret the geological processes. The models employ mathematical interpretation of theoretical concepts and the calculations proliferate greatly for systems with many components. It is therefore necessary to use powerful computers in order to solve the large number of coupled equations.

The geochemical computer program that is most general is the EQ3/6 package designed by Wolery /3-3/ and further developed in /3-4/. This software package is ready for use and is implemented on SKB computers. It has been used with success to simulate both field and laboratory tests on a number of occasions.

Even though today's geochemical models are extensive and in general well-validated and verified, there are processes of importance in a final repository that can be dealt with in a better way. Development is therefore required within certain areas, such as kinetics, sorption and thermodynamic data.

### Calculation Models for Nuclide Transport in the Geosphere

The generation of transport models used for the far field in KBS-3 calculated the transport of nuclides from the near field up to the nearest fracture zone. An advection-dispersion model was utilized, supplemented with surface sorption, diffusion into the open microfissures in the rock and chain decay.

Progress has since been made with, among other things, a stronger coupling between the geohydrological calculation models, which give the flowpaths from a repository site, and the transport model. Knowledge of fracture zones and their retardation potential has improved and is now judged sufficient to permit a modelling of transport in fractures zones as well. The chemical data required for modelling have also been improved, see further in Chapter 7.

Observations in rock of channelling and rapid transport pathways of the water flow have led to

development of special channelling models for calculation of nuclide transport. Such a model has been used in safety assessments of SFR and WP Cave. For a further development of the channelling model, more field data from tunnels and deep holes are required. The models will be tested in connection with tracer tests.

The network model being developed within the Stripa Project can be utilized in both flow and transport calculations. However, the models are still in the experimental stage and it will be a long time before they can be of use in the safety assessment.

The discharge from the geosphere to the biosphere is discussed in Chapter 12.

## PROPER

A major problem in the safety assessment is that there may be considerable uncertainty in certain input data, owing to a natural variation or to uncertainties in measurement. In order to evaluate how the uncertainty in the input parameters is translated into uncertainties in calculated consequences, a software package called PROPER has been developed within SKB.

The purpose of the PROPER software package is to provide the performance assessor with a computerized method for studying how uncertainties in input data are propagated into the model calculations.

The core of the PROPER package is the monitor, which is used to

- link together a number of submodels, taken from a library during the run, into a total model for the problem at hand, and to
- propagate the uncertainties in the input data parameters through the sequence of submodels.

This is accomplished without tampering with the source codes to the monitor or the submodels. The same monitor can use different sets of submodels.

Each submodel constitutes a separate program module, either an internal FORTRAN subroutine or and external FORTRAN program. The monitor checks the execution of each such module and collects raw statistics. The modularization is permitted by the fact that communication between the submodels is handled via an internal database, which is created temporarily during the simulation.

The distributions in the input data are translated into distributions in the results by means of Monte Carlo technique through repeated random sampling. The monitor provides several control mechanisms related to the random sampling procedure, including optional variance-reducing methods and repeated measurement of precision, carried out during the run, and comparison with optional criteria for automatic interruption of the simulation. Correlations between parameters can be introduced.

The monitor is now available in a fully tested version 1.0 /3-5/, and will be utilized in SKB 91. Since the monitor merely collects raw statistics, separate post-processing programs must also be used. At present,

three different programs are available for sensitivity analysis and graphic presentation /3-5/.

Submodels have been developed in accordance with the timetables presented in R&D-Programme 86 to provide opportunities for generic assessments and to demonstrate the possibilities of the methodology. The recently developed first generation of submodels /3-6,7/ takes into account chain decay and generally lies on a level of complexity equivalent to that in KBS-3. The near-field model regards a copper canister and takes into account diffusive material transport, canister corrosion, solubility limitations and easily accessible activity (in the clad gap and grain boundaries). The far-field model takes into account advective and dispersive transport as well as diffusion and sorption in the rock matrix around a channel.

Close international cooperation for further development of probabilistic models of the type discussed above is being pursued within OECD/NEA, see section 13.11.1.

### 3.3.3 Site-specific Databases

GEOTAB /3-8/ contains data from all of SKB's site investigations. Further surface-based site investigations or updatings of old investigations will be carried out on three candidate sites between the years 1992 and 1994. Databases for possible final repository sites will thereby be built up. Certain routines for QA have been established /3-9,10,11,12/ and new ones will be added.

Information from the pre-investigations for the Hard Rock Laboratory at Oskarshamn will be used to predict the properties of the area at repository depth (cf. Chapter 9). The validity of the predictions will then be tested against data from excavation of the access tunnel and construction of the Hard Rock Laboratory. Experience from these studies will serve as a basis for defining the scope of the necessary investigations on the candidate sites.

With the aid of SKB 91 and site-specific data from the candidate sites, the importance of possible differences will be evaluated and comprise part of the material for planning of the detailed geological site investigations.

### 3.3.4 Criteria and Regulatory Requirements

In its review of the previous R&D-programme, SKN remarked that no direct measures connected to decision-making criteria had been defined in SKB's six-year programme. SKN recommended that SKB compile material as a basis for the regulatory authorities' work with decision-making criteria and that an account of the work with decision-making criteria should be included in R&D-Programme 1989.

Since SKB has only received informal and preliminary information on the ongoing intergovernmental cooperation between the Nordic countries to issue recom-

recommendations for the design of the final repository, it has not been possible to plan the R&D measures to satisfy any specific criteria during the past three-year period. The work has therefore been aimed at dealing with important questions within the area in a general fashion. Examples of such questions are:

- scenarios; how can it be demonstrated that the set of scenarios that has been studied is complete? See section 3.3.1,
- validity; how is validity established and how shall it be established that the models used are sufficiently valid for their purpose? The question is being considered by several groups, see section 3.3.5,
- probabilistic modelling; how can account be taken of the fact that certain parameters of importance for the safety of a final repository consist of distributions? See section 3.3.2,
- the ALARA principle; how shall safety requirements be balanced against national financial resources to influence the overall risk picture to individuals? /3-13/

None of these areas is, however, of such a nature that a deadline can be specified for when the work should have achieved such a level of quality that the work can be terminated. A progressive focusing of the measures is necessary as the regulatory system evolves. The scope of the work must be continuously adapted to the potential for further development, as well as the will of the authorities to formalize the requirements in concrete criteria.

A discussion of how SKB can best assist the authorities in developing a system of criteria should be initiated after the Nordic recommendations have been published.

### 3.3.5 Confidence

In order for a safety assessment to constitute the ground for a decision that the final repository is acceptably safe, an evaluation must be made of how sensitive the results are to uncertainties in the assessment or variations in different premises. The credibility that can be attached to an assessment is dependent to a high degree on the predictability and analyzability of the system.

The methods currently available for evaluating the influence of parameter uncertainty in model calculations can be roughly divided into stochastic and deterministic.

Stochastic simulation is used in computer programs such as PROPER and the Canadian SYVAC in order to directly translate distributions for input data into distributions for results. Stochastic simulation is also used, for example in hydrology modelling, to take into account, by means of an estimated spatial variance, the fact that the properties of the rock are not strictly known in points other than where the measurements are made.

Kriging is a statistical interpolation method developed for ore prospecting and now also used in connection with hydrological modelling. The results are obtained without any simulation procedure, however.

A deterministic procedure with which the sensitivity derivative of the equation system can be obtained directly numerically has been developed by a group at Oak Ridge National Laboratory in the USA. The methodology is currently being tested by the Swedish Nuclear Inspectorate and will also be evaluated by SKB. It appears, however, to be less suitable in cases where there is a large variability in the input parameters.

One of the main purposes of SKB 91 is to analyze in detail a reference case around which variation analyses and sensitivity studies can be carried out. These analyses will be utilized in the early 1990s as a support for the siting of the final repository and in the choice of design and system during the mid-90s.

Confidence in how well models can describe reality is characterized by the concept of validity. Validity is in general not an absolute concept, but must be related to the purpose for which the model is used.

Validity is established by comparing the predictions of the model with tests in different parameter areas from well-defined laboratory experiments to natural analogues. The concept of validity is currently being discussed in a number of contexts, in connection with validation exercises at Stripa (Chapter 10) and at the Hard Rock Laboratory (Chapter 9), in connection with the study of natural analogues (Chapter 11) and in the international cooperation in INTRAVAL (Chapter 13). The practical implications of the concept of validity must be further elucidated in these different areas of use before an international consensus has been established on how it is to be used in the context of the final repository.

Confidence in the validity of the results is influenced by the validity of the models, but also by the quality of the database and the calculation work. SKB intends during the coming three-year period to work continuously on quality assurance in preparation for the siting decisions and the system selections.

## 3.4 PROGRAMME

### 3.4.1 1990–1992

#### SKB 91

The detailed description of the background material to be gathered for SKB 91 is provided in a work report /3-14/, along with the analysis methods intended to be used and the timetables for this. This work report will be progressively revised as background material emerges and its quality can be better evaluated. A general plan for the work is presented below.

The conceived facility will have roughly the same design as the one in KBS-3, ie a 1 km<sup>3</sup> large repository

at a depth of about 500 metres where encapsulated waste will be deposited in specially drilled deposition holes.

The assessment will be based on geodata from the Finnsjön area, supplemented with certain information from SFR. Site-specific geochemistry and topography will be utilized. The nuclide inventory will be updated on the basis of discharged fuel and current forecasts of future burnout. The temperature will be limited to max. 100°C.

The models intended to be used shall in principle be defined and functioning early in 1990. Supplementary documentation and data will be compiled with the same time horizon. In order to avoid having incompatible calculations in different phases of the assessment, premises, models and data will be fixed as of July 1, 1990, ie no new model versions will be introduced and the database will not be changed.

The calculation work and the evaluation of the results will be performed during the second half of 1990 and the first half of 1991. A review and definition of scenarios will be completed by early 1990, after which interesting variations can be defined successively during 1990. In connection with the assessment, tests will be conducted to systematically quantify various kinds of uncertainties and evaluate their importance. The work of studying the importance of variations in input data will continue also after SKB 91 has been submitted. It will then constitute a running account of the importance of the safety-relevant parameters adapted to the other activities. During 1992, the variation studies will be concentrated on material coming from the site studies.

Variation analyses are also expected to be initiated by regulatory authority questions on SKB 91.

A summary report will be published during the fourth quarter of 1991.

### Calculation Program for Near-field Transport

**Equilibrium models.** SKB is collaborating with Lawrence Livermore National Laboratory in the development of the geochemical code EQ3/6. During 1990, surface complexation will be introduced into the model. The ongoing work of validating the thermodynamic database will continue and the goal is to have evaluated data for U, Pu, Tc, Np, Am and Th in time for SKB 91.

**Near-field transport.** During 1989-90, sensitivity studies will be conducted on the near-field models from KBS-3 to see where further development is necessary. The redox front models will be coupled to permit calculation of the migration of the redox front through the buffer and out into the rock. During 1991, calculations and variation analyses will be carried out for SKB 91.

**Coupled models for geochemistry and transport.** A new model that describes the migration of fronts in the near field will be developed starting in 1989 and during a couple of years to come. This model will be used as a complement to current models.

**Alternative near-field design.** Comparison studies between different near-field designs will be commenced when SKB 91 is concluded.

### Calculation Program for Far-field Transport

The database for the channelling model used in the SFR and WP Cave assessments will be further refined. During the period, data on groundwater seepage will be collected from tunnels, shafts and deep holes and analyzed with respect to information concerning degree of channelling.

The development of the models used for calculating nuclide transport in stochastic two-dimensional fractures continues. The models will be modified to permit matrix diffusion to be taken into account. Further development will take place to obtain a channel model with stochastic transport characteristics which can be incorporated into three-dimensional network models. In this model, in contrast to the channelling model, it will be possible for channels to merge, mix water and separate.

Development of models for calculation of groundwater flow in discrete fractures is taking place within the Stripa Project, see section 10.2.2. A simple transport model will be incorporated in one of these models, NAPSAC, see section 6.2.3, during 1990/91. In the long run, these calculation models may be applied within the safety assessment.

It is as yet impossible to say which of the above transport models will be used in SKB 91.

### PROPER

Method development within PROPER is difficult to schedule, since the focus of the work will primarily be defined by experience gained from using the package in connection with SKB 91. Certain minor measures can be identified already today, however.

There is quite a bit of overhead in the system's way of handling communications between the submodels. A new version of PROPER's monitor will therefore be produced. Version 2 is intended to be easier to use and more flexible. The work is planned to be finished by mid-1990.

The development of a new integrated program for postprocessing has commenced. A screen handler and menu control will be introduced for greater user-friendliness. This work will be completed in the mid-1990.

During the second half of 1990 and during 1991, activities are planned regarding statistical methods for postprocessing and for development and testing of variance-reducing methods.

As an aid to model designers, continued measures are foreseen for development of numerical methods and production of service routines. Such methods and routines have thus far mainly been prepared in connection with the development of the demo models. New demo models may have to be developed to demonstrate



certain types of problem solutions. Work of this type may have to be pursued continuously and will be adapted to meet needs that arise in connection with the use or PROPER.

### **Scenario Development**

Method development within the scenario area will be adjusted to the ongoing work within NEA and to the need for safety assessments and variation studies within the R&D-programme as a whole.

The processing of experience gained from different international activities concerning scenarios will serve as a basis for how scenarios are reported in SKB 91 and the level to which they will be processed. SKB intends to define a suitable reference scenario for SKB 91, as well as other design basis scenarios. The latter question is, however, dependent to some degree on how the Swedish acceptance criteria will be formulated. A summing-up of the situation is planned for R&D-Programme 92.

### **Acceptance Criteria**

A report on the Nordic regulatory authorities' discussion concerning acceptance criteria for facilities for the final disposal of radioactive waste is expected to be submitted in 1990. The material must be analyzed with respect to the consequences it might have on the execution of the safety assessments.

### **Quality Requirements and Quality Control**

A systematic review will be carried out during 1990–1992 to establish QA guidelines adapted to the state of

development of the activities. This applies primarily to handling, storage and documentation of data and programming and documentation of computer programs.

### **3.4.2 1993–1995**

During 1993, and possibly the early part of 1994, additional variation studies will be carried out for the candidate sites and for culling of the alternatives for repository design and barriers. The early efforts (during the period 1992–1994) will be concentrated on factors that may constitute requirements on a repository site, for example the total space requirement and the associated repository layout. During the period 1995–1997, the remaining background material for the choice of system design for the near field will be gathered.

During the period, data from the Hard Rock Laboratory and other site investigations will permit further refinement of the far-field models. Corresponding development of the near-field models may be necessary on account of new barrier types etc.

Methodological development for safety assessments will generally take place in response to arising needs and opportunities for further refinement.

Since detailed investigations are planned to commence during 1995 of candidate sites for the final repository, the safety-related importance of going down to the repository level with a shaft or tunnel in different parts of the study site will be examined.

## 4 REPOSITORY DESIGN

### 4.1 GENERAL

The Government's approval of KBS-3 in 1984 means that a method exists today for the final disposal of spent nuclear fuel that fulfils society's demands on safety and radiation protection. Ongoing R&D is aimed at obtaining adequate background material for siting and selecting, among possible alternatives, a suitable design as a basis for a siting application. In these alternative studies, the KBS-3 design constitutes a reference alternative, see Figure 4-1. Only alternatives that offer advantages within one or more of the following areas will be studied:

- technical feasibility,
- cost-effectiveness,
- radiological safety and development potential,
- confidence in the safety assessment.

As the repository design evolves, the thrust of the R&D will be adjusted to support the buildup of

databases and development of models that are required. R&D-Programme 86 discussed alternatives for the disposal of spent nuclear fuel /4-1/. One of the alternatives discussed was the possibility of storing waste under surveillance and control. CLAB constitutes a temporary storage facility where the storage time could be increased if necessary from the 40-year period currently foreseen to 100 years /4-2/.

A possibility for completely dry repositories was also discussed. It was found that this, under present-day Swedish conditions, requires a reliable drainage system, with accompanying long-term surveillance of the function of the drainage system. SKB concluded in 1986 that it was necessary to clarify society's view of such systems that are dependent for their long-term safety on surveillance.

In its review report /4-3/, SKN deems that such systems should be given low priority since it is difficult to demonstrate their long-term safety. SKB shares this view and does not plan to study systems that are depend-

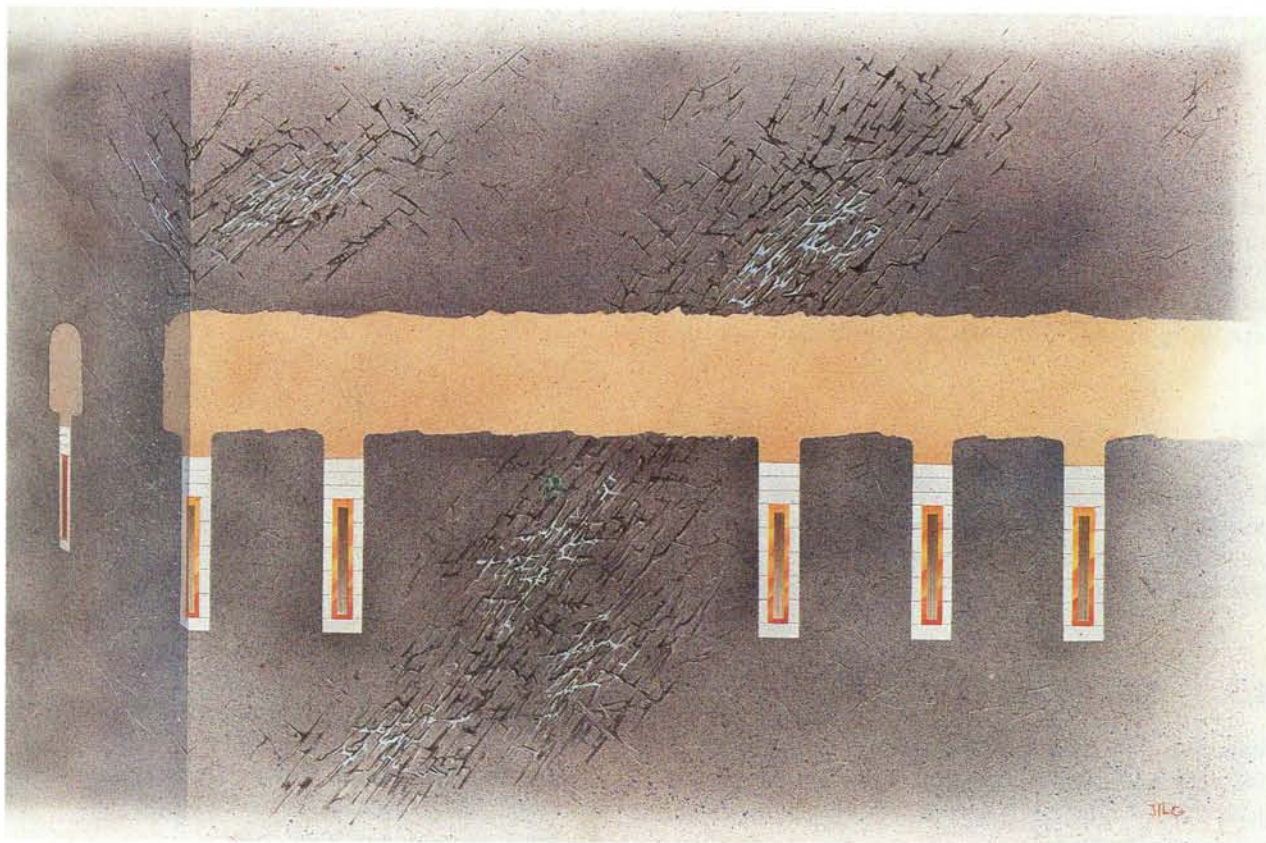

Figure 4-1. Final repository according to the KBS-3 method permits good adaptability to varying rock conditions.

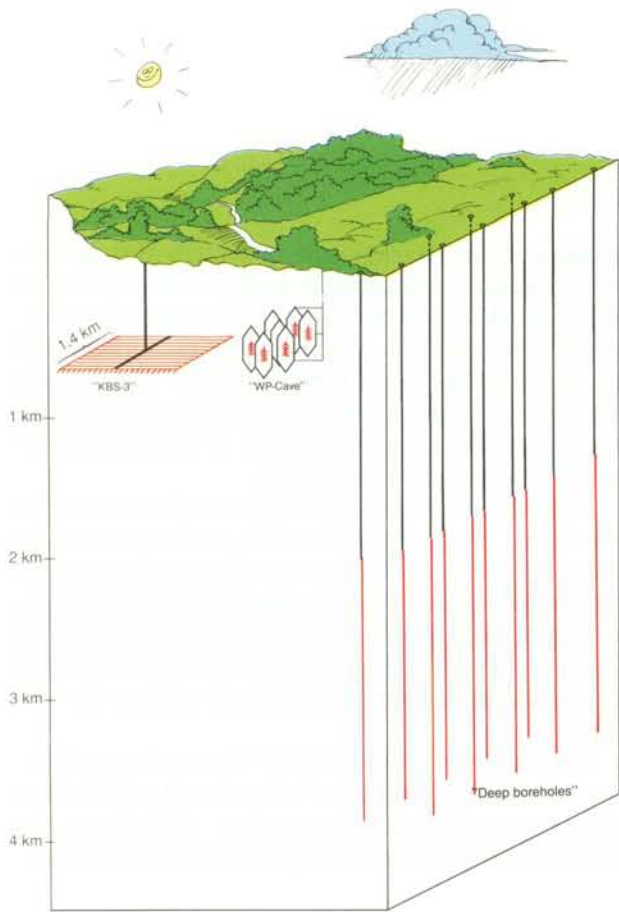

Figure 4-2. Conceptual alternatives to final repository design.

ent for their safety on long-term supervision and maintenance. This does not, however, mean that the repository designs studied cannot be kept under surveillance if this should be deemed desirable, or that opportunities for future generations to make changes in the repository should be prevented or obstructed.

## 4.2 GOAL

The goal is to be able to select a conceptual final repository design by the mid-1990s. This system will then be optimized with respect to temperature, canister and sealing measures in the chosen repository location.

## 4.3 ALTERNATIVE DESIGNS

Since the 1986 research plan, two repository alternatives that are fundamentally different from KBS-3 have been studied. These are "WP-Cave" and "Deep boreholes", see Figure 4-2.

The means employed to isolate spent fuel from the biosphere are choice of location in the rock, encapsula-

tion and measures to give canisters a good disposal environment in the rock. A good design shall enable available technology for application of the engineered barriers, canister, buffer material and backfill, with sealing measures, to be adapted to the inherent qualities of the rock as an isolating medium.

### 4.3.1 WP-Cave Design

WP-Cave is based on an engineering of barriers adapted to prevailing rock conditions.

The design evaluated by SKB during a period of two years and previously dealt with by SKN in the NAK-WP-Cave project /4-4/ incorporates:

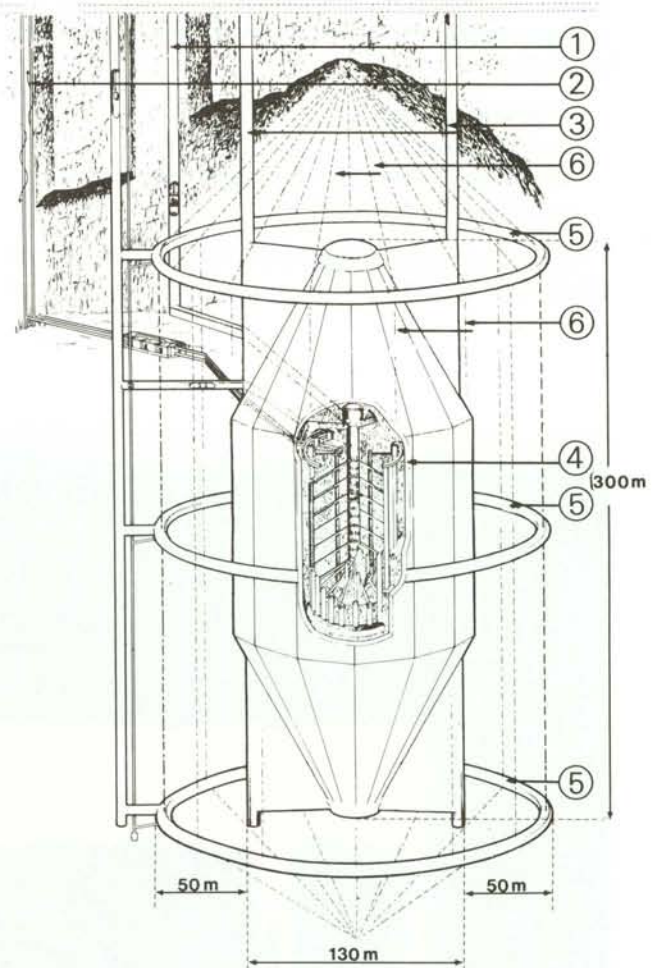

1. Shaft for waste canisters
2. Ventilation shaft
3. Shaft for removal and refilling of bentonite/sand barrier.
4. Bentonite/sand barrier with a thickness of about 5 m.
5. Drift in the hydraulic cage
6. Borehole in the hydraulic cage

Figure 4-3. Design of WP-Cave.

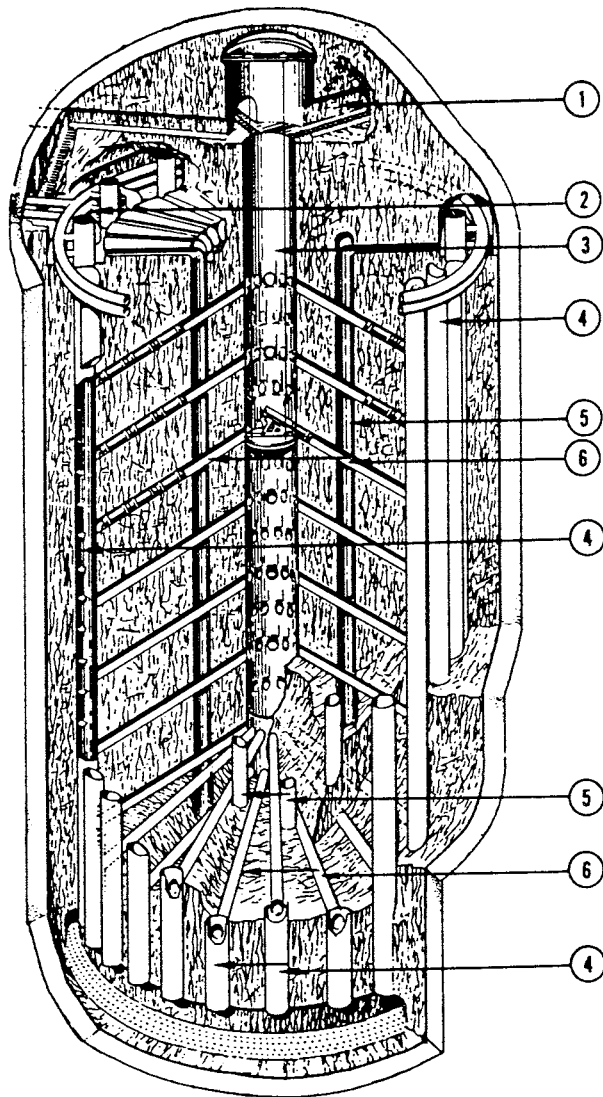

1. Vault for large waste packages
2. Heat exchanger
3. Central shaft
4. Outer ventilation shaft
5. Inner ventilation shaft
6. Canister duct

Figure 4-4. Storage section of WP-Cave repository.

- canisters of steel,
- five-metre thick bentonite-sand barrier med 10% bentonite in the bottom, 20% in the cylindrical parts and 50% in the upper parts,
- hydraulic cage.

The studied design of WP-Cave is shown in Figure 4-3. The spent fuel is placed in the centre of the facility and surrounded by a barrier of rock. Around this a slot is blasted, which is backfilled with a mixture of bentonite

and sand. Outside the bentonite-sand barrier, a hydraulic cage is arranged, consisting of horizontal drifts interconnected by vertically drilled drainage ducts.

The size can be varied. A WP-Cave calculated to be able to accommodate fuel corresponding to 1 100 tonnes U, ie one-seventh of the Swedish programme, has the dimensions shown in Figure 4-3. This size is termed WPC 1100.

The central portion of the repository, where the fuel is stored, is illustrated in Figure 4-4. From a shaft in the middle, storage channels radiate outward at a 30° downward slope. There is room for twelve such channels on each level. Their diameter is so much larger than that of the fuel canisters that there is room for cooling air to pass.

The cooling air circulates downward in the outer vertical shafts, through the canister channel and upward in the inner shafts. After heat exchange, the air is recirculated.

In WPC 1100, two canisters in a row are stored in each channel. Each canister holds 16 BWR assemblies or 5 PWR assemblies. Figured for BWR assemblies, the weight per canister is about 2.9 tonnes U. This means that 1 100 tonnes U require 16 levels (384 canisters). The height of the inner repository is hereby about 110 m, if the vertical distance between each level of storage channels is 3.5 m.

The canister is assumed to be of steel with a low carbon content.

All storage channels and shafts are assumed to be lined with steel in order to ensure a dust-free environment in all ventilation ducts. Concrete is not used, since this material is not judged to offer any special long-term advantage from the viewpoint of safety.

The rock mass between the central repository and the bentonite-sand barrier shall protect the bentonite from becoming excessively hot. The requirement is that the temperature should not rise to more than 80°C in the bentonite. This has resulted in the dimensions presented in Figure 4-3, which are, however, slightly conservative. The premise in determining the number of canisters in each storage channel is that the temperature should not rise to more than 150°C on the surface of the canisters. If three canisters should be placed in each storage channel, the temperature on the surfaces of the canisters would rise to more than 200°C, but would still not be more than 80°C in the bentonite.

On closure, after about 100 years of ventilation and surveillance, all open space inside the bentonite-sand barrier is backfilled with fine sand, finer than 0.1 mm, and water. This is to create a chemical environment that can be described with good accuracy.

### 4.3.2 Deep Boreholes, Design

The utilization of modern technology for deep-hole drilling has been proposed as a method for disposing of waste at very great depths in the rock.

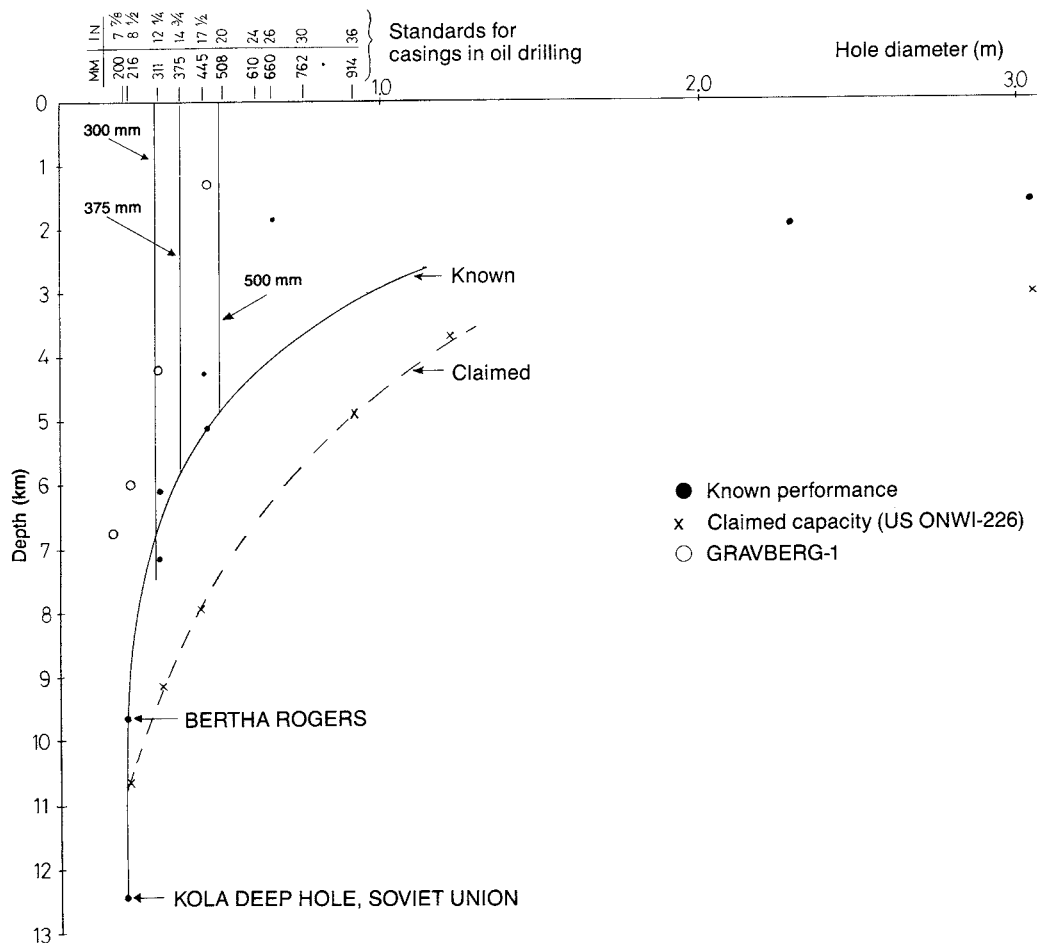

Figure 4-5. Achieved and claimed diameters of boreholes at different depths.

Available drilling technology limits the diameter of holes with increasing depth, see Figure 4-5. Experience in drilling to great depth in Swedish bedrock has been gained in connection with the attempts to find gas at Gravberg on Lake Siljan. This opportunity has been exploited to study the possibility of using deep-hole technology for the disposal of spent nuclear fuel.

The bedrock at Gravberg is fractured to a depth of 900 m. Fracture zones, 2–20 m thick, lie below that depth with typical average spacings of 200–300 m. The hydraulic conductivity in the rock at a depth of 1.5–3 km is  $10^{-10}$ – $10^{-9}$  m/s.

The 12 km deep Kola Peninsula hole has been reported to have a hydraulic conductivity of  $10^{-12}$  m/s at a depth of 6 km, and the borehole at Cajun Pass in California has been reported to have hydraulic conductivity of  $10^{-12}$  m/s at a depth of about 2 km. A large seepage of saline water was observed in the Kola Peninsula hole at a depth of 4.5 km. At depths greater than 800 m, the groundwater was saline. Saline water at great depths is also known from Finnish and Swedish bedrock. In other words, bedrock at great depths can

be expected to be transmissive. The presence of other groundwater in the upper 700–1000 metres and in more conductive flat zones can help limit the water flux at great depths.

Experience at Gravberg showed that drilling difficulties increased rapidly at depths greater than 5 km [4-5]. The studies are now being concentrated on evaluating more detailed designs of deposition holes with depths of 4–5.5 km and diameters of 0.4–0.8 m, see Figure 4-6, and how groundwater movements caused by thermal convection can be modelled with expected quality in holes and in surrounding rock. It is hereby assumed that the spent fuel will be deposited in canisters emplaced at a depth of more than 2 km and under a tightly-plugged upper section.

### 4.3.3 Construction Methods

Deposition holes shall have space for canisters and buffer material which, in interaction with the rock, limits the water flux in the near field. A method for making

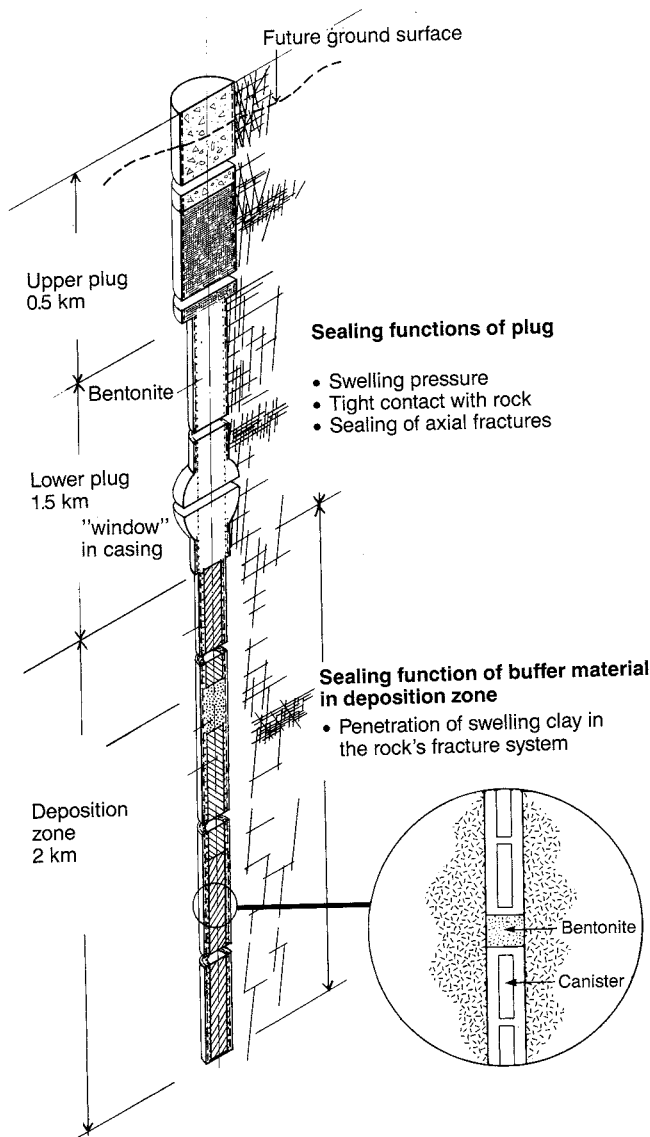

Figure 4-6. Deep deposition hole. Sealing with swelling clays will be carried out in connection with drilling and deposition.

deposition holes may be core drilling or percussive or rotary drilling. No directly suitable equipment exists today, and little experience exists of the possible impact that drilling might have on the isolating characteristics of the surrounding rock. The Stripa Project includes development of technology for sealing of fractures caused by the core drilling of deposition holes on half scale. It is not probable that a technology for the drilling of deposition holes will be developed for any other purpose within the foreseeable future. SKB's R&D-programme includes such development, with the goal of identifying connections between hole-making methods and possible impact on the rock. A proposal for a method to be tested on field scale is being prepared, and will serve as a basis for development of equipment and subsequent practical tests in the Hard Rock Laboratory.

## 4.4 COMPARISON OF ALTERNATIVE

### 4.4.1 WP-Cave

A comparison has been made between KBS-3 and WP-Cave /4-6/. They represent two fundamentally different principles with regard to the concentration of the spent fuel in the repository rock. The comparison aimed at providing material for a prioritization of the direction of future research within SKB.

The comparison resulted in the following conclusions:

- Both concepts are judged to be able to provide acceptable safety.
- A utilization of the potential of WP-Cave would, however, require considerable work on model development in areas where present-day understanding and data are incomplete. This is particularly true with regard to long-term stability in the groundwater flowpaths in the temperature fields existing inside and outside the bentonite barrier.
- The higher temperatures in WP-Cave lead, via uncertainty in data and dominant processes, to a higher uncertainty in the calculated consequences. Many years of internationally coordinated work would be needed to reduce these uncertainties.
- Both repositories, including the incorporated barriers, are judged to be able to be built with a normal modification of available technology.
- On non-site-specific grounds, it cannot be said today whether it would be easier to find suitable sites for one design or the other.
- The WP-Cave design is considerably more expensive.

A future research orientation toward concentrated storage of spent fuel in a distributed fashion in accordance with WP-Cave is therefore judged to entail greater uncertainty as regards the possibilities of achieving acceptable safety, at the same time as which the costs would be higher. The studies of WP-Cave as an integral system will therefore not continue.

A number of barriers included in WP-Cave will, however, be further studied in the R&D-programme. Examples are the importance of iron in the repository in the form of canisters or structural elements, and the importance of preferential flowpaths regardless of whether they have been created intentionally (as in a hydraulic cage) or unintentionally (as in the case of stress redistribution due to the making of holes in the rock).

Methods for how iterative bedrock investigations in connection with the construction of a final repository can be utilized for emplacement of the repository in a simulated typical rock of SFR character have begun to be studied, see Chapter 6. Information on rock quality gathered successively during repository construction can be used to a higher degree for emplacement of KBS-3, owing to its distributed character, than for emplace-

ment of WP-Cave, which requires a fixed geometry for its different parts.

#### 4.4.2 Deep Holes

The feasibility of disposing of waste in boreholes at great depth has been studied on the basis of the information obtained in connection with deep-hole drilling. The preliminary results indicate favourable economics. However, there is today a lack of material permitting a clear comparative evaluation of the deep-hole concept as an alternative. The studies will continue.

#### 4.4.3 Miscellaneous

As far as other alternative repository designs are concerned, parameters such as canister material, buffer material and chemical conditioning of the near field are being studied within the relevant programme area and with the timetables given there.

Alternative technology for repositories and barriers will mainly be studied from the end of the 90s and up until the time the design work is to commence.

Adaptation of site and engineered barrier system to each other, as well as a systematic optimization of the repository, will not be commenced until the end of the 1990s.

## 4.5 RESEARCH PROGRAMME 1990–1995

The studies of deep-hole deposition and its safety aspects will be completed during 1990 with a comparative analysis with the reference concept KBS-3.

A conceptual study of an alternative design, whereby long deposition tunnels are excavated out under the Baltic Sea, will be carried out, possibly based on the information obtained at the Hard Rock Laboratory. However, a sufficient body of material on which to base a judgement is not expected to be available until about 1992/93. Certain supportive research concerning pre-investigations of water-covered areas will be carried out. See Chapter 2.

By 1995, alternatives of the type

- one or more canisters in each deposition hole,
- deposition in long drilled holes between transport tunnels,
- deposition in tunnel centre or drilled holes,

must have been examined to such a level that characteristics of importance for the detailed geostudies have been defined.

# 5 ENGINEERED BARRIERS

## 5.1 WASTE FORMS

### 5.1.1 Goals of the R&D Activities

The stability of spent fuel in groundwater is being studied in order to obtain by 1995 the knowledge of the mechanisms and kinetics that is required for being able to model the dissolution of  $\text{UO}_2$ . This model shall be able to be used as a source term for safety assessment. Better knowledge of how fuel dissolves in groundwater will permit optimization of the canister in terms of design and material. It will also permit optimization of the near field to the canister and is of great importance for determining the requirements on rock quality.

### 5.1.2 Present-day State of Knowledge

Direct disposal of spent fuel was proposed at the end of the 1970s /5-1, 2/. Since then, the various aspects of direct disposal have been examined in varying detail in a number of countries. Sweden, Canada, the USA and the Federal Republic of Germany have studied this field for almost ten years. The state of knowledge in the world for spent fuel as a waste form was recently summarized by Johnson and Shoesmith /5-3/.

The present-day Swedish programme for studies of fuel started in 1982. It was then based on a preliminary investigation conducted in 1977 as a part of the KBS-2 work. The situation for SKB's research within the field is summarized in a technical report /5-4/. Only a brief description is provided in this chapter.

In all, only some thirty scientific reports have been published dealing with the stability of spent fuel in water. Many variables influence stability in water, such as the fuel's irradiation history, groundwater chemistry, redox potential ( $E_h$ ) and temperature. It is therefore not surprising that the mechanisms for fuel dissolution are not yet completely understood. Despite limited data, however, some aspects of the dissolution mechanisms are relatively well understood and it is now possible to provide a description of the influence of the most important variables on the kinetics of fuel dissolution.

## INFLUENCE OF IRRADIATION HISTORY

### Gap Inventory

The fuel's irradiation history is of great importance for the release of volatile fission products, for the fuel's

microstructure and for the precipitation of fission products at the grain boundaries. Cesium and iodine, together with the fission gases xenon and krypton, are released from the fuel matrix to the empty space inside the fuel rod. The quantities liberated depend, among other things, on the temperature of the fuel during operation.

### Grain Boundaries

Certain fission products, such as cesium, seem to continue to be selectively leached even after long exposure to groundwater. This is not surprising, since the first step in release from the matrix is enrichment at the grain boundaries. This selective leaching is probably limited to atoms that do not fit into the  $\text{UO}_2$  matrix. There are no signs that compatible elements such as lanthanides and actinides should be leached selectively.

Very little is known about how large a fraction of the fission products is present at the grain boundaries. Studies still in progress indicate that several tens of percent of the inventory of 4d metals (Mo, Tc, Ru, Rh, Pd) may be present as separate phases at the grain boundaries.

## GROUNDWATER COMPOSITION

It is well known that carbonate forms strong uranyl complexes. This is reflected in a much higher uranium solubility in carbonate-containing water compared with distilled water, see Figure 5-1. The release of fission products does not seem to be affected in the same way by these changes in water chemistry, see Figure 5-3.

The measured concentrations of uranium agree well with calculations based on available thermodynamic data. Good agreement has also been obtained for plutonium. However, further research will be required to bring knowledge of other actinides up to the same level as for uranium.

Thermodynamic data show that high chloride concentrations in the water do not significantly influence the dissolution of  $\text{UO}_2$ . This is also verified by studies conducted in Canada. At  $25^\circ\text{C}$ , the dissolution of caesium, strontium and technetium were largely the same in 1 M chloride as in chloride-poor carbonate-containing water. At temperatures above  $150^\circ\text{C}$ , however, substantial increases in the rate of dissolution have been reported. The cause of this increase in saline solutions at high temperature is unknown. In distilled water and in carbonate-containing water, the increase is only moderate.



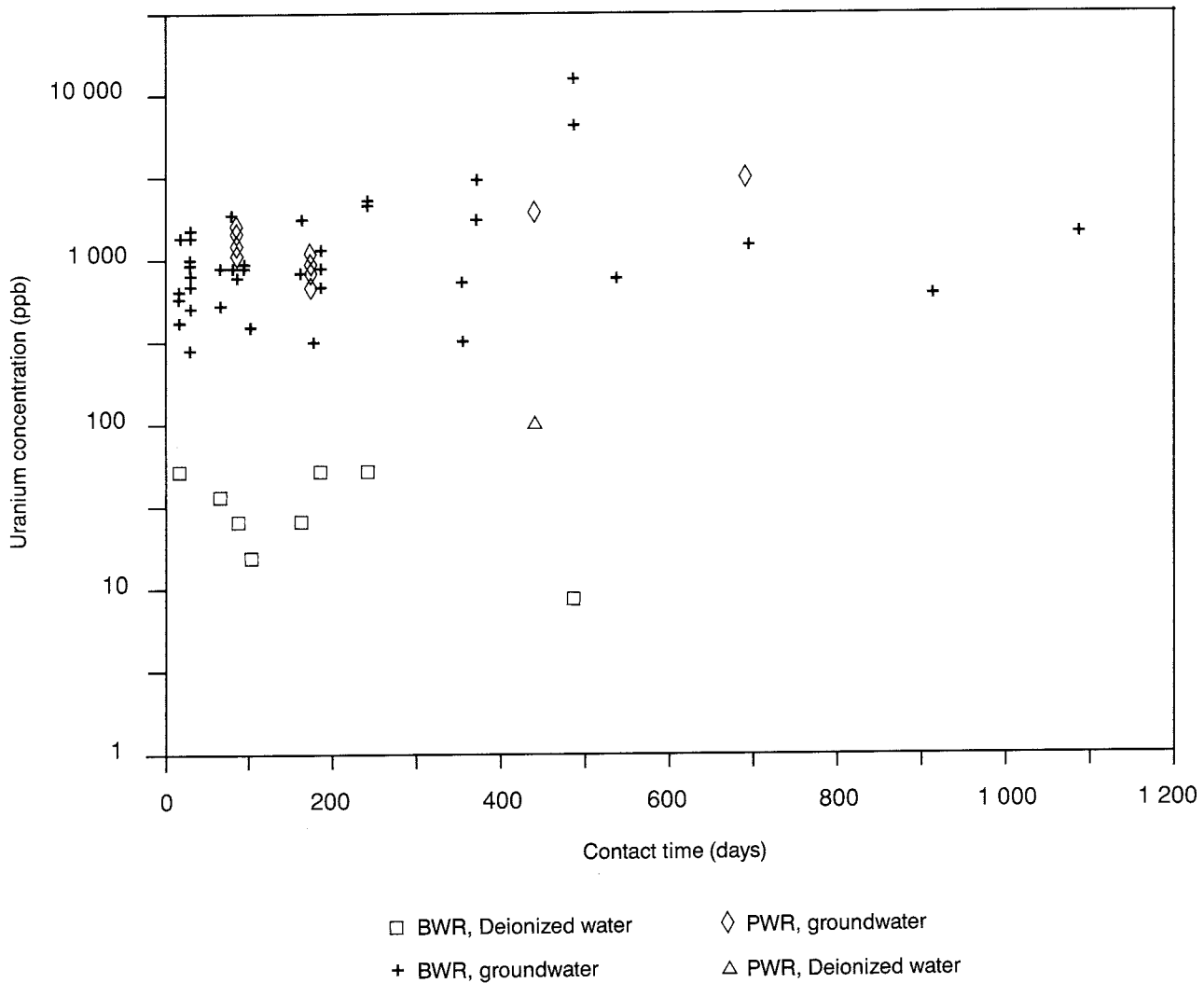

Figure 5-1. Uranium concentration in centrifugate for high-burnup BWR and PWR fuel.

## REDOX POTENTIAL

The redox conditions at the surface of the fuel have a very great influence on the mechanisms for fuel dissolution. Under reducing conditions,  $UO_2$  is stable. The dissolution of the fuel can be described with equilibrium processes. At higher redox potentials, an oxidative dissolution can take place. This is a dynamic process related to factors such as morphology. It is also linked to radiolysis from the fuel, which can give rise to local oxidizing conditions on the surface of the fuel.

Electrochemical investigations performed in Canada have clearly shown the importance of oxygen content and redox potential in the dissolution of  $UO_2$ . The rate of dissolution of  $UO_2$  appears to be proportional to the partial pressure of the oxygen. Even for spent fuel, the dissolution rate decreases significantly when the oxygen concentration decreases.

Alpha radiolysis of a thin layer of water nearest the fuel surface can produce locally oxidizing conditions,

even if the near field is reducing. The fact that alpha radiolysis causes oxidizing conditions has been demonstrated in Canada by electrochemical studies of unirradiated  $UO_2$ . The experiments that have been performed with irradiated fuel have not confirmed these observations. But it is reasonable to assume that the redox potential at the fuel surface is higher than in the rest of the near field and the far field. This may mean that  $UO_2$  is not the stable uranium oxide and that the fission products and actinides may be released by oxidative transformation of the fuel matrix.

The uranium and actinide concentrations have been shown to be constant and independent of contact time under both oxidizing and reducing conditions. See, for example, Figures 5-1 and 5-2. This indicates that the dissolution of these elements is solubility-limited and not controlled by the rate of transformation of the matrix.

For the fission products, the interpretation of the results is more uncertain. Strontium is generally considered to be dissolved in the matrix. It turns out,

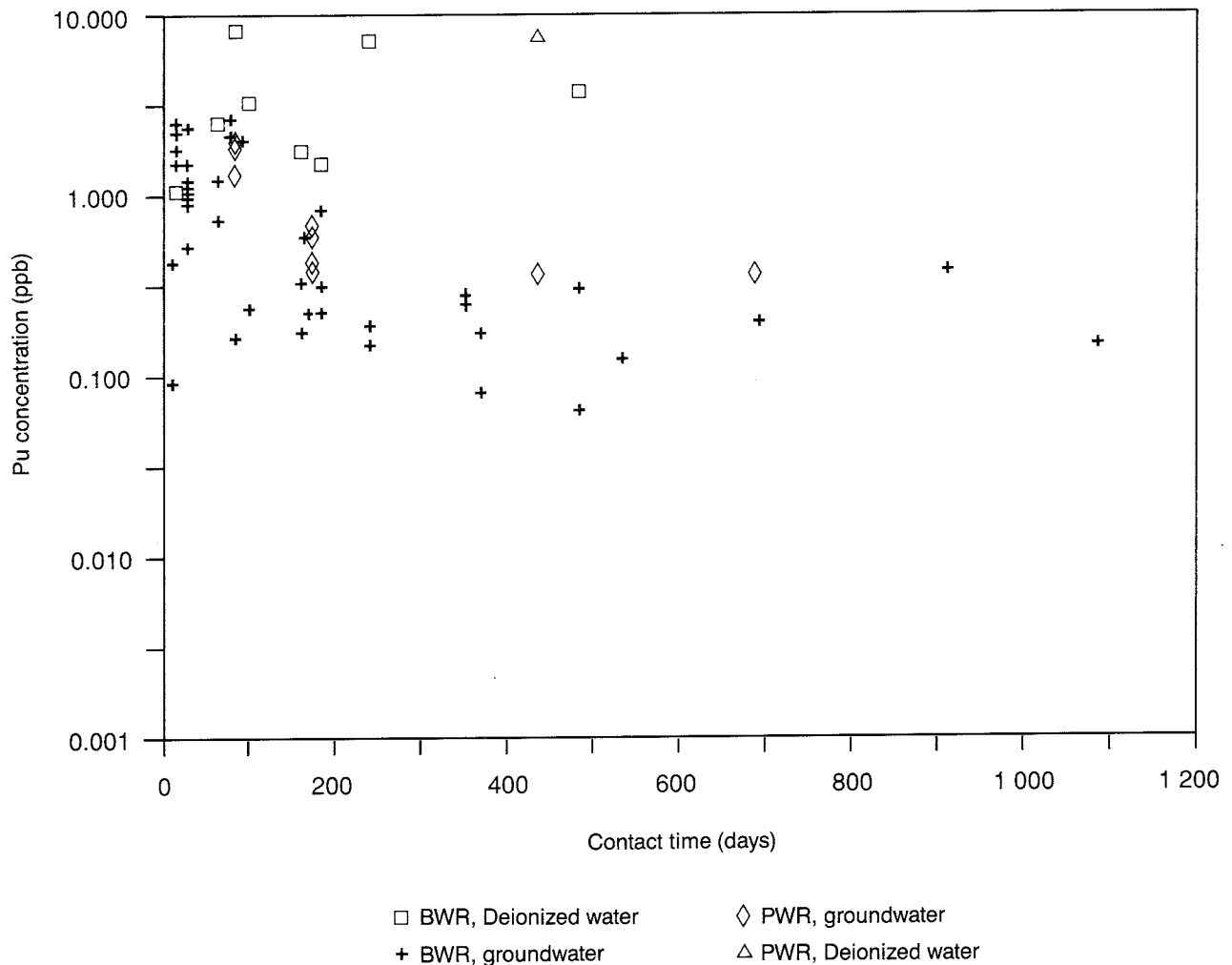

Figure 5-2. Plutonium concentration in centrifugate for high-burnup BWR and PWR fuel.

however, that the leaching of strontium from the fuel is independent of uranium saturation. It is mainly dependent on the total time the fuel specimen has been in contact with water, see Figure 5-3. Figure 5-3 also shows that the leaching of strontium can be different for different specimens. The two groups of curves in Figure 5-3 represent two different parts of a BWR rod. The results therefore appear to be a combination of leaching due to oxidation of the  $UO_2$  matrix and possibly some selective leaching of grain boundaries.

### TEMPERATURE

Fuel dissolution under oxidizing conditions has been studied in the temperature range  $25^\circ C$  to  $200^\circ C$ . Available data point towards a relatively small temperature dependence, equivalent to an increase by a factor of about 10 between  $25^\circ C$  and  $150^\circ C$ . No reliable data exist for reducing conditions.

### OTHER COMPONENTS IN THE NEAR FIELD

A preliminary study has been conducted of the influence of bentonite on the dissolution of fuel under oxidizing conditions [5-5]. The results show that the concentrations in solution of fission products and actinides decline markedly due to sorption on the bentonite. The concentration of uranium remains unaffected. This is assumed to be due to the fact that uranium forms anionic complexes with carbonate. These anions are not sorbed as effectively by the bentonite. The presence of bentonite did not lead to any increase in the dissolution rate.

### MODELS

A transport model with very simple assumptions for fuel dissolution was used in KBS-3. Oxidizing conditions were assumed to prevail at the fuel surface. Elements with a higher solubility than uranium were assumed to

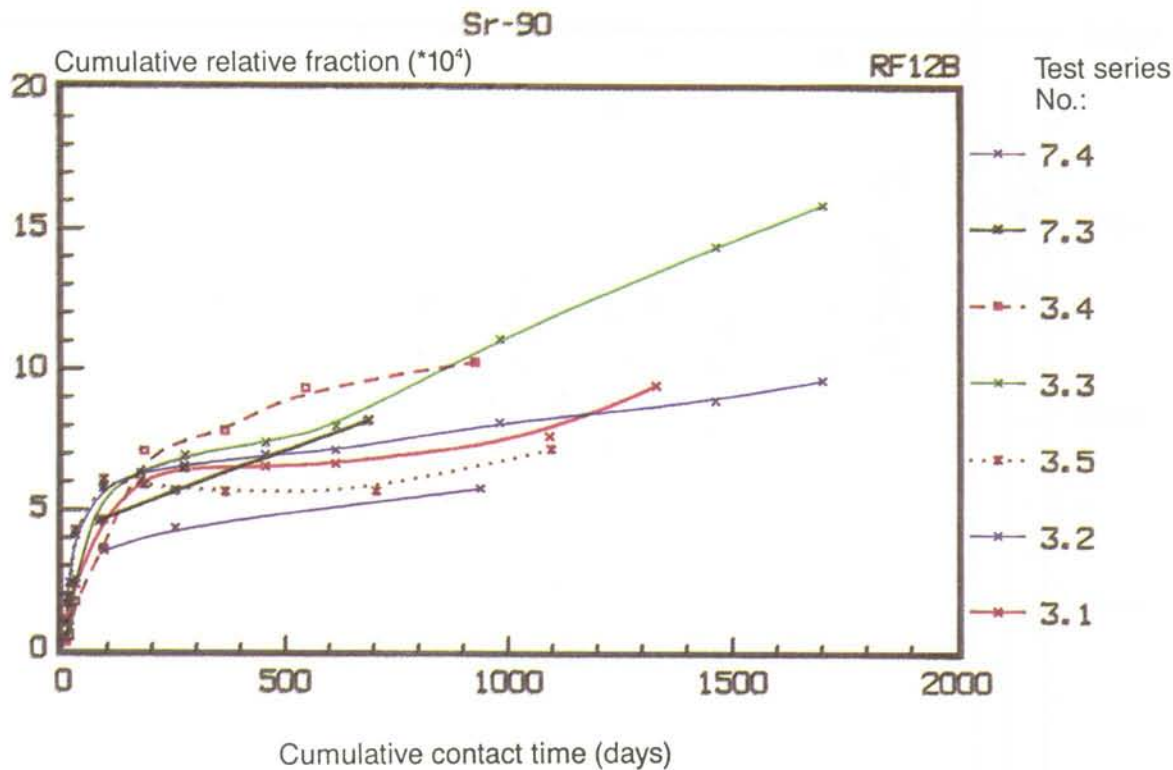

Figure 5-3. Cumulative liberated fraction of strontium during leaching of BWR and PWR fuel.

be limited by matrix dissolution. The release of other elements was assumed to be solubility-limited.

Such a model is actually only strictly applicable under conditions when the fuel surface has been oxidized to no higher than  $UO_{2.25}$ . If the surface oxidation has reached  $UO_{2.23}$ , the dissolution is oxidative and the model must be based on dissolution kinetics.

A model for the dissolution of  $UO_2$  based on the solubility of the fuel surface has been developed at AECL /5-6/. This model couples a convection/diffusion model for dissolved uranium with a boundary condition defined by the uranium solubility at the fuel surface. In order for such a model to be able to be adapted to oxidizing conditions, the boundary conditions at the fuel surface must be defined so that the kinetics for oxidative dissolution are taken into account. The dissolution process will now be irreversible and dissolved U(VI) species may be precipitated as secondary phases.

### 5.1.3 Important Review Comments from R&D-Programme 86

The National Board for Spent Nuclear Fuel approved SKB's plans for the continued work by and large, but questioned whether the schedule can be met. Studies of spent fuel have high priority for SKB, but the work is

limited to some extent by the availability of resources in Sweden in terms of personnel and equipment.

Some changes have also been made in the plans on the basis of the Board's recommendation that SKB pay greater attention in its programme to the influence of the buffer material on fuel corrosion. In response to this recommendation, investigations have been conducted of fuel corrosion in the presence of a) a dilute bentonite suspension, and b) highly-compacted bentonite. The first of these investigations has been concluded and the results reported /5-5/. The second is still being evaluated. As foreseen, the complexity of the experiments caused difficulties with the analyses. These problems have now largely been solved and a more complete initial report may be completed during 1989. A preliminary account was submitted in 1988 /5-7/.

As a result of the revision of the programme, a number of planned activities have been delayed. This does not jeopardize the overall timetables, however, although they are still tight.

### 5.1.4 Research Programme 1990-1995

The main factors that influence the behaviour of spent fuel in groundwater are:

- 1) the irradiation history of the fuel, which affects the microstructure of the fuel and is of great importance for the precipitation of radionuclides at cracks and grain boundaries,
- 2) the redox potential and the influence of alpha radiolysis on the redox conditions nearest the fuel surface,
- 3) the water chemistry, especially in the presence of other components in the near field,
- 4) the thermodynamics of the actinides.

Large gaps still exist in knowledge within these areas. The largest lie within the following areas:

- the distribution of fission products and actinides between grain boundaries and the fuel matrix. A grain boundary inventory can be released faster and with other mechanisms than matrix-bound radionuclides,
- redox conditions at the fuel surface (influence of radiolysis). This is of importance in determining whether a model for solubility-limited dissolution or a model for kinetically controlled dissolution is to be applied,
- thermodynamic data for certain elements, such as Tc, Pu and Np. This applies to both species in solution and any solubility-limited solid phases.

Over the last three-year period, the emphasis in the work has been on studies of corrosion of spent fuel in groundwater in order to create a database that is statistically reliable. Investigations of this type have now been greatly reduced. At present, only a few test series with BWR fuel and about a dozen series with PWR fuel are being conducted. During the coming period, the emphasis will be on other kinds of experiments where more specific questions will be studied. These investigations will be conducted on BWR and PWR fuel, as before. During the latter part of the period, the investigations may be broadened to cover gadolinium-doped fuel as well.

## MICROSTRUCTURE OF THE FUEL

The release of fission products and actinides from the fuel takes place from three different sources. During operation, Cs and I have been released from the fuel matrix and are readily accessible for leaching in the gap between the cladding and the fuel and in cracks in the fuel. Other fission products, such as Pd, Tc, Ru, Rh and Mo, may have formed separate phases in the fuel. In this way, segregated material can be released faster and via other mechanisms than those radionuclides that are trapped in the UO<sub>2</sub> matrix. It is therefore important that the spent fuel be characterized with respect to the distribution of the fission products and actinides. This in-

formation is of great importance for the work with development of predictive models.

Experience from the preceding period has shown that this work is complex and time-consuming. Experience from the JSS project has shown that analysis of the solid phase is necessary in order to obtain the knowledge of the kinetics and mechanisms of corrosion that is required to model the process. This area has high priority and research efforts will be stepped up compared with the preceding period. However, resources within Sweden are limited. Close cooperation with foreign researchers and institutions will therefore probably be necessary. As before, the main techniques used will be optical microscopy, SEM, STEM/TEM, microprobe analysis and Auger spectroscopy. The investigations will be conducted on existing PWR and BWR fuel, but will be augmented with investigations of a segment rod subjected to a controlled power increase in the R2 reactor. The power increase produces a different temperature distribution than in a commercial reactor and results in a redistribution of mobile fission products in the fuel.

## RADIOLYSIS

The available experimental data show that radicals formed during radiolysis of water cause oxidation of UO<sub>2</sub>. While the irradiation fields used in the experiments have been much higher than can be expected near the fuel surface in a repository environment, it is nevertheless reasonable to assume that conditions at the fuel surface are oxidizing, even though the size of the radiolytic effect is not known. This means that the release of radionuclides from the fuel will take place through oxidative dissolution.

During the preceding period, investigations have been conducted of radiolytic oxidation in a gamma field. The part of these experiments being conducted in Sweden will be concluded within the next year. A possible continuation of these experiments will take place within the framework of an ongoing joint project with AECL of Canada. During the next three years, the emphasis will be on experimental investigations of the effects of alpha radiolysis, especially in oxygen-free systems.

The experiments that have been conducted under oxidizing conditions, by allowing the leachant to be in contact with a volume of air, undoubtedly give an upper limit for the oxidation rate. But the actual rate in an oxygen-free system is not known. During the period, oxidation through alpha radiolysis will be investigated both in model systems and in systems that include spent fuel.

## CORROSION OF HIGH-LEVEL FUEL

The corrosion studies of PWR and BWR fuel will continue during the next few years. In comparison with the preceding period, however, fewer but more specific ex-

periments will be carried out. The analysis work will also be more extensive for each experiment. As before, particular attention will be given to the following phenomena:

- solubility and saturation effects,
- type of corrosion on the fuel,
- colloid formation,
- oxidizing/reducing conditions.

Some of these phenomena have already been discussed in more detail in other sections and will therefore not be taken up under this heading.

### **Solubility and saturation effects, the thermodynamics of the actinides**

General data on actinide and fission product solubilities in groundwater will be determined within the framework of SKB's chemistry programme, see Chapter 7. During the past period, the uranium database for hydroxides and carbonates has been updated and validated /5-8/. At present, corresponding work is under way for phosphates and silicates. This work is expected to be concluded within the next three years. In addition to the work with uranium data, an updating of the databases for technetium and plutonium has also been begun. In both cases, the updating entails both a critical review of literature data and experimental determination of data.

A comparison between experimental equilibrium concentrations for uranium and calculated solubilities for possible solubility-limiting uranium(VI) phases indicate a discrepancy of a factor of between 10 and 50 for oxidizing conditions. The discrepancy is not surprising in view of the fact that no solubility-limiting secondary phase has yet been identified with certainty experimentally. The kinetics for the dissolution of UO<sub>2</sub> and the precipitation of the secondary phase are also inadequately understood. Work on these problems has begun and will continue during the next few years. This work also entails determining the oxidation state and species for radionuclides in solution to as great an extent as possible.

### **Water Chemistry**

Since KBS-3, the site investigations have shown that relatively high chloride contents can occur, particularly in coastal areas. Chloride concentrations of more than 10 000 ppm have been measured. These levels are not so high that they can be expected to have a crucial effect on the solution chemistry of actinides and fission products. But some experiments are intended to be carried out to confirm this.

The composition of water that comes into contact with bentonite is also strongly affected. Some increase

in the bicarbonate concentration has been measured for Mx 80. For calcium bentonites that have been conditioned with soda, the increase in bicarbonate content can be considerable. It is not quite clear whether this influence on water composition is permanent or merely transient, since this excess carbonate can be expected to be leached out of the bentonite. The influence of carbonates on the dissolution of UO<sub>2</sub> is well known, but in this case as well a number of specific investigations will be done.

In addition to the carbonate content, the sulphate content also increases to several thousand ppm in contact with bentonite. Sulphate contents in this concentration range are not expected to affect the solution chemistry of the more important actinides and fission products. Moreover, this increase may also be transient. However, several experiments involving leaching in synthetic bentonite interstitial water are intended to be conducted to confirm this. Experiments in synthetic bentonite interstitial water will also be one step in the studies of the more complex, realistic repository conditions.

### **Colloids**

During the preceding period, the colloid and particle fractions have been characterized solely by means of filtration through membrane filters. This provides an approximation of the quantity of particulate/colloidal material, but is much too insensitive a method to provide a good idea of the size distribution. Tests with more sophisticated methods have been conducted, but the results have not been encouraging. Development of methods and technology is continuing and progress in this area will be monitored, and further work may be done during the coming period.

### **MODEL DEVELOPMENT**

The purpose of model development is to devise a predictive model for corrosion of spent fuel over long periods of time. Such a prediction is only meaningful if the dissolution mechanisms in the short and the long time perspective are known and quantified. The work is proceeding along the same lines as were defined in the previous research programme. The main goal for the coming period is to develop a more realistic model for fuel dissolution than the KBS-3 model to use in the safety assessment for SKB 91.

The work is based on the assumption that the fuel dissolution can be oxidative and controlled by radiolysis. This means that a kinetic model must be used, at least during an early phase of fuel dissolution. In a longer perspective, when the alpha activity has decayed, fuel dissolution can be described with the aid of a solubility-limiting model. These two models will therefore be developed in parallel during the period.

## 5.2 CANISTER

### 5.2.1 Goal of the R&D Activities

The goal of the studies of canister materials is to have sufficient knowledge of both copper and alternative materials by 1995 in order to make a final choice of canister material. This applies to both corrosion resistance and other material properties of importance for canister design and for the mechanical stability of the canister.

### 5.2.2 Present-day State of Knowledge

In all programmes for final disposal of high-level waste, it is assumed that the waste will be encapsulated in an impervious container prior to deposition. In most countries, the aim is an absolutely impervious containment with a canister life of about 1000 years. In addition, Sweden and several other countries have as an alternative, or as the main alternative, long-term containment (about 100 000 years) in canisters.

The foreign research programmes with repository geologies that are most relevant for Swedish conditions are Canada, Switzerland, Finland and the EC.

Canada has chosen titanium as a reference material and copper as an alternative material. For both materials, the research centres around a relatively thin-walled canister with a life on the order of 1000 years. The purpose of the research is to obtain an understanding of the possible corrosion processes by using electrochemical techniques for studying the mechanisms and long-term experiments for confirmation. Owing to the combination of short canister life and the thin-walled material, the research is largely centred around corrosion under oxidizing conditions. In addition, the Canadian groundwater in the projected repository areas has a very high chloride content, about 1 mol/l. Titanium and titanium alloys are highly corrosion-resistant, especially in chloride-containing waters. General corrosion is very small, but the materials have proven to be somewhat sensitive to crevice corrosion. The research is being focussed on studies of the conditions for crevices and the propagation rate of crevices. In the case of copper, the research is heavily concentrated on investigations of the corrosion kinetics of general corrosion under oxidizing conditions, but knowledge gaps have also been identified with regard to pitting in connection with sulphide corrosion.

In the Swiss programme, the main alternative is a thick-walled steel canister, with a copper canister as the secondary alternative. The steel canister is supposed to have a life of at least 1000 years. Research during the past few years has primarily been focussed on hydrogen-producing corrosion and stress corrosion cracking.

The Finnish programme is very similar to the Swedish and the main alternative is a copper canister of roughly the same type as the Swedish canister.

As was pointed out in R&D-Programme 86, the research work on copper is being conducted in more long-term projects. Most of the work has not yet been concluded, but is expected to be concluded during the coming period.

The research on copper corrosion is concentrated on investigations of pitting under reducing conditions. Phase 1 is concluded and a new phase will begin during the latter part of 1989. As yet, nothing has been found to change the conclusions of KBS-3, ie that the most probable value of the pitting factor is 5. The evaluation of the first canon to be salvaged from the warship "Kronan" has been concluded and published /5-9/. The bronze, which has a very high copper content (96.3% as compared to a normal value of about 90%), showed very little corrosion, equivalent to less than 10 mm in 100 000 years.

The method development of HIP technology for copper was concluded during the period. The results show that with inert handling of the copper powder, it is possible to produce a sintered material with a ductility and mechanical properties that are comparable to the properties of ordinary copper metal. Stress corrosion tests showed that the HIPed material did not have higher sensitivity to stress corrosion cracking than OFHC copper /5-10/. The development of welding technology is still progressing within the framework of a EUREKA project. The definition phase was concluded during the preceding period. Phase two was started in 1989.

An initial phase of the studies of the creep properties of copper has been concluded /5-11/. The study has revealed considerable differences in creep properties between the weld, the heat-affected zone and the parent metal. In addition, as yet preliminary results indicate that the creep ductility of copper is relatively low. Further research is therefore required before the creep properties of copper under repository conditions are fully understood.

For steel as the canister material, the work has been concentrated on studies of pitting during the aerobic period in the repository. A statistical study of the pitting process has also been carried out /5-12/. With the exception of a few long-term tests, the studies of pitting are concluded. The results have also been applied in a preliminary evaluation of the life of a steel canister in a KBS-3 repository. With a wall thickness of 100 mm, a life of about 1000 years can be achieved.

The research activities for titanium are concluded. Long-term exposures of up to 6 years with titanium in contact with bentonite have been evaluated. These tests show an incipient crystallization of the oxide layer, and in some cases an increase in the growth rate (corrosion rate) has been observed /5-13/.

Two alternative designs of a copper canister with a thickness of at least 10 cm were presented in KBS-3. These were fundamentally different with regard to closure technique and compactness. The welded and lead-filled canister had a lead fill with a residual

porosity equivalent to no more than 2% of the internal volume. During use, the copper canister will undergo creep deformation under the external pressure. Recent research has been devoted to the properties of the copper in connection with such creep deformation (see above). A description of the creep in a welded copper canister that takes into account realistic low stresses and possible fracture mechanisms has not yet been forthcoming, however. Nor is there any basis for an assessment of the behaviour of the pressed canister in connection with scenarios with movements in the bedrock that directly affect the canister.

Model development for rock/buffer/canister mechanical interaction is in progress, see section 5.3.3.8. With this model, deformation of the copper can be calculated if a design basis or a scenario – for example movement in rock with deposition holes due to temperature effects, glaciation or the like – has been defined. When the fracture mechanism has been clarified, this provides a basis for canister design or consequence description which in turn provides a basis for the safety assessment. Naturally, it is not meaningful to test other fill materials in the canister that give greater porosity without this design basis.

A steel canister can be designed with a chosen safety factor to fracture. A description of the probable fracture mechanism in connection with overload and/or corrosion is not yet available. A copper canister that is supported internally by a steel canister is an interesting alternative for continued studies.

In the design of welded canisters, special attention shall be given to the possibilities for quality assurance with regard to canister integrity and possible material changes in the zone surrounding the weld. The R&D-programme shall include such analyses of the relationships between quality and design.

### 5.2.3 Important Review Comments from R&D-Programme 86

The National Board for Spent Nuclear Fuel said that canisters consisting solely of corroding material did not have to be included in the SKB programme. SKB does not believe steel should be dismissed as a canister material merely because of its shorter expected life. Only if research results and available data do not clearly indicate that the desired canister life can be achieved, or if a shorter canister life will have unacceptable consequences, can the canister material be dismissed. It should be emphasized that copper is still the main alternative and has top priority. In the continued programme, steel is to be regarded primarily as an alternative to lead as a load-bearing component in a canister (see below). In SKB 91, however, a steel canister will also be studied in order to examine as fully as possible the consequences of early canister penetration.

The sensational observation that copper might corrode with hydrogen gas evolution /5-14/ has been check-

ed by two independent studies /5-15,16/. In neither case has hydrogen been detected, despite the fact that the equipment used was capable of detecting a hydrogen production rate only one-thousandth of the rate reported by Hultquist. No scientifically satisfactory explanation for Hultquist's observations has been forthcoming.

Naturally, it must be assumed that the encapsulation process will not take place with absolute infallibility. At present, SKB has not decided whether defective canisters are to be repaired or quite simply enclosed in another canister. SKB intends to take up this question in greater detail in connection with the design of the encapsulation plant.

SKB shares the viewpoint of the Board and the reviewing bodies that so-called "delayed fracturing" of ceramics is not merely to be regarded as a material property, but is highly dependent on the manufacturing technology. Moreover, it is a statistically related phenomenon, and observations of specimens from small-scale manufacture can to some extent be irrelevant for the assessment of the probability of delayed fracturing in a full-sized canister. Against this background, TAC in Canada has drawn the conclusion that studies of the stability of ceramics in water are only relevant if they are related to a full-scale production of canisters of such materials /5-17/. On the same grounds, SKB does not consider ceramic canisters to be of interest for Swedish conditions.

### 5.2.4 Research Programme 1990–1995

The most urgent research areas for the period are as follows:

- corrosion assessment for potential canister materials,
- testing/development of technique for non-destructive testing,
- definition of fracture mechanisms and distribution in time of canister failures.

### CORROSION STUDIES

For copper, current investigations are concentrated on supplementary studies of pitting of copper under reducing conditions. These investigations are being combined with further evaluation of archaeological material.

As was discussed above, the studies of pitting on steel are nearly concluded, and only a few long-term exposures will be evaluated during the period. Beyond these, studies are being conducted of the influence of hydrogen-producing corrosion under reducing conditions. These studies are divided into three parts: (1) Electrochemical measurement of the influence of hydrogen gas production on reaction kinetics. (2) Investigation of the properties of the corrosion product layer. (3) Long-term testing (up to two years) of the corrosion rate under hydrogen gas pressure. These studies are

relevant both for a pure steel canister and for a copper canister internally supported by steel (see below).

Investigations of the growth of the passive film on titanium were concluded during the period. The results indicate certain changes that can be of importance for the long-term stability of the passive film. These results must be further evaluated before it is possible to make a decision regarding continued studies. As before, any Swedish measures will be planned so that they complement the more extensive Canadian investigations.

## **MATERIAL PROPERTIES**

The creep properties of copper and welded joints in copper at low stresses are not yet completely understood. Further work in this field will be done during the coming three-year period.

## **SEALING TECHNIQUE**

Electron beam welding is still considered to be the method with the greatest development potential for canister sealing. The research in this area is being done within the framework of a EUREKA project in collaboration with the Welding Institute and other foreign interests. During the period, work will also be done on non-destructive testing of electron-beam-welded material.

## **CANISTER DESIGN**

A canister design without the requirements on heating entailed by lead fill and HIPing according to KBS-3 requires an analysis of the relationships between dimensions, external pressure and fracture loads as well as the opportunities for quality control offered by a self-supporting canister.

A steel canister designed to relevant portions of Swedish regulations and codes for pressure vessels will have, depending on the design of the ends, a wall thickness of 7–8 cm with an external pressure of 15 MPa. It can be provided with a corrosion protection of copper.

Alternative designs of copper and/or steel canisters are being considered with respect to manufacture, handling and quality control. In connection herewith, any necessary tests for quality control of seals, welds and the like are being identified, along with hydrostatic testing or other types of load testing.

Tests are being conducted with the intention of verifying theory for designing against failure and rigorouslyness of quality control.

## **5.3 BUFFER AND BACKFILL**

### **5.3.1 Background**

Buffer material in deposition chambers and backfill material in rock caverns, tunnels and shafts are examples of engineered barriers included in the final re-

pository system. The primary function of the barriers is to limit groundwater flow. Buffer material shall also constitute a chemical and mechanical zone of protection around canisters in the rock. Sealing measures can be adopted in the form of plugs in rock chambers and sealing of the fracture system in the rock by means of injection grouting.

### **5.3.2 Goal of the R&D Activities**

The goal is to be able to select buffer and backfill materials by the mid-1990s and specify properties of importance for final repository performance. Alternative deposition methods and final repository designs shall be compared taking into account the geological characteristics of the site.

In R&D-Programme 86, it was stated that material and properties were to be described so that a choice of deposition method can be based on

- a clarification of the relationship between different clays, mixed materials, the repository environment and the properties of the materials of importance for the engineered barriers,
- a theoretical model developed for calculations,
- developed and tested methods for sealing rock.

Furthermore, a plan was described for a broadening of knowledge and model development with the goal of being able to choose materials around the year 1995.

The subsequent review and commenting procedure resulted in recommendations for research concerning:

- connection between high temperatures and long-term stability of the bentonite,
- chemical conditioning, admixture of crushed rock etc,
- rheology, water uptake, erosion resistance,
- effects of gas,
- sealing measures in boreholes and shafts,
- model development for barrier performance,
- QA programme.

Research has been conducted more or less intensively within all of these areas. An account is provided below, divided into the above areas.

### **5.3.3 Present-day State of Knowledge**

#### **5.3.3.1 Long-term Stability of the Bentonite**

As early as December 1983, the second workshop on the stability of smectite-rich clays under the influence of such factors as temperature was organized /5-18/. The general opinion of the participants was that smectite/illite alteration took place in stages involving Si release, increased charge through substitution of Al, Mg and inward transport of K with irreversible fixation



and formation of the non-swelling clay mineral illite. It was recommended that conditions in nature where illite formation took place be studied. The continued SKB research has been focussed on both studying natural conditions, including development of methods for characterization of clay mineral, and conducting hydrothermal tests of cleaner clays in laboratories. The importance of mineral changes for the barrier properties of the material has to do with how minerals interact with water in the microstructured arrangements that are characteristic for the clays and that are also determined by density and water composition, among other factors.

Recent years' research has therefore been largely devoted to trying to explain the relationships between the microstructure of the clay minerals and water in different parts of the pore system of importance for both the isolating properties that determine the conditions of transport and the rheological properties that are of importance for mechanical interaction between canister and rock.

Studies of relatively pure Wyoming bentonite with, for example, autoclave tests at temperatures up to about 200°C, and investigations in the electron microscope, have led to a more nuanced model for change of the microstructure with temperature /5-19/, see Figure 5-4. Two new bentonite deposits with samples of material with a traceable temperature history have been utilized for thorough studies with results that support the proposed model for microstructure changes. Of particularly great interest is the case with bentonite at 500 m depth at Hamra on Gotland. It has retained its isolating characteristics without any sign of cementation and has maintained 110–120°C for at least 10 million

years and is probably contemporary with Kinnekulle (Ordovician) /5-38/.

### 5.3.3.2 Chemical Conditioning, Mixing with Crushed Rock etc

The possible advantages of mixing “getters” in buffer material for the purpose of increasing retardation is a question that is dealt with in near-field chemistry, see Chapter 7.

There is no known suitable thermodynamically stable fill material that can be used as a buffer material, as mentioned in the reviewers' replies to R&D-Programme 86. It is probably a mistake based on confusion between canister and buffer material.

Material additives lead to altered premises for assessment of long-term effects.

A study of the clay/quartz system with experiments lasting 70 days did not reveal any appreciable dissolution and precipitation of Si at a temperature of 115°C and a pressure of 20 MPa. The literature refers to cases where this has been achieved at higher temperature (270°C) /5-20/.

A study of crushed rock compared with sand with 10% admixture of bentonite for each material has been carried out on laboratory scale. Shear deformation was imposed on compacted, non-water-saturated samples and changes in permeability were measured by means of gas flow measurements in the shear region. Shearing led to an increase in permeability, but was no higher for crushed material than for sand as the aggregate.

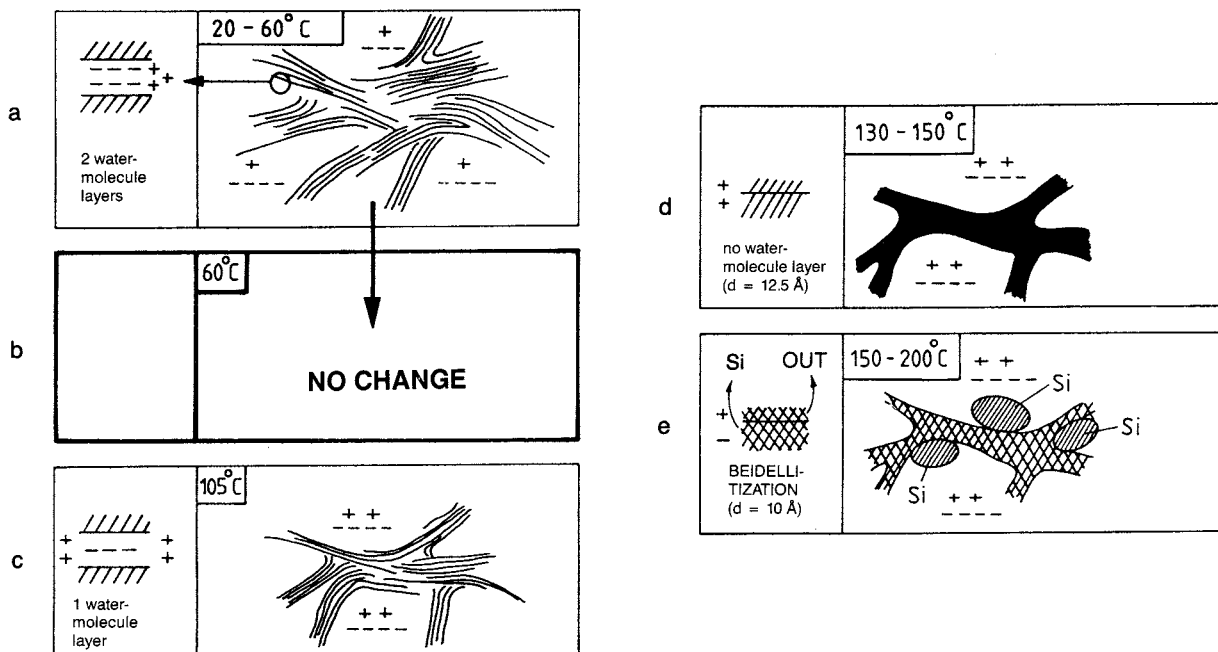
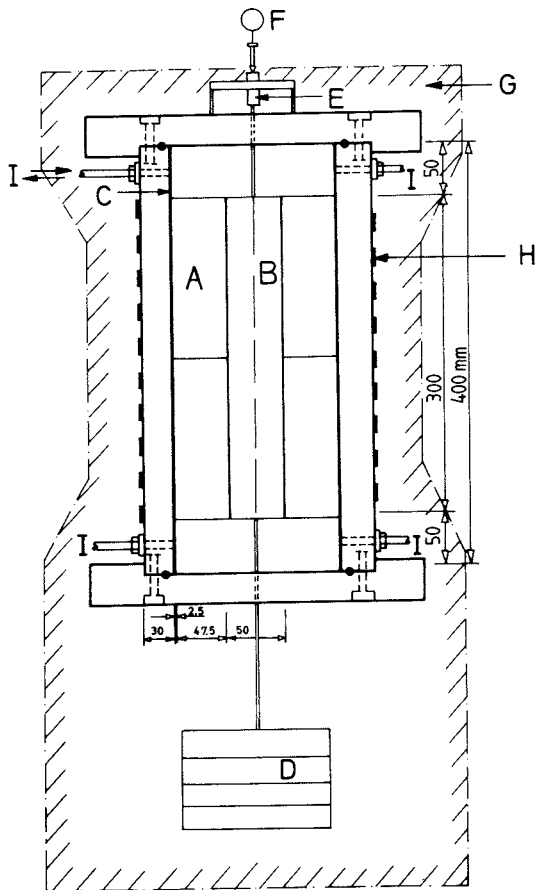

Figure 5-4. Schematic model for the flaky clay particles' microstructural changes and release of silicon at high bentonite density. The base plane distance,  $d$ , is the distance between individual clay particles.



- |                           |                       |
|---------------------------|-----------------------|
| A) Bentonite block        | B) Copper canister    |
| C) 2.5 mm filter          | D) 80 kg lead weights |
| E) Induction strain gauge | F) Dial indicator     |
| G) Heat insulation        | H) Heating coil       |
| I) Drainage pipe          |                       |

Figure 5-5. Experimental setup for measurement of settlement of a simulated canister in a deposition hole.

### 5.3.3.3 Rheology, Water Absorption, Resistance to Erosion

Long-term creep in clay under the influence of the load from the canister in the deposition hole can be described in a theoretical model if the rheological properties of the material are known. These are measured in the laboratory with good geotechnical equipment. At present, creep tests are being conducted with very small shear stresses and with elevated temperature. The intention is that a creep model for Na bentonite should become available during the year.

An experiment in a laboratory simulating a canister in a deposition hole, see Figure 5-5, was conducted between April 1985 and December 1985 /5-21/ and was followed by an experiment at Stripa that is still in progress. In addition to loading with a simulated

canister in a deposition hole, the experiment concludes heating and cooling for thermomechanical data. Theoretical calculations of the same processes with a material model based on the geotechnical measurements and adapted to finite element programs is being compared with experimental data for validation.

The material model is supported by development of a creep model based on a greater understanding of the degree of organization of the interlamellar water and the kind of binding between this water and the mineral substance.

Water absorption in bentonite was studied in the Stripa BMT test with half-scale simulated deposition holes under realistic rock conditions. The availability of water in the rock and redistribution of water in the hole due to heat from the simulated canister were the reason for the uniform absorption /5-22/.

The homogenization process associated with swelling and compression is being studied in geotechnical measuring equipment to obtain data for a material model to be used in FEM analysis (ABAQUS). The models are intended to be used for deposition holes/rock fracture geometry. A high-temperature test (170°C) with a French smectite-rich clay has been in progress at Stripa since 1986.

Erosion conditions in bentonite gel have been studied in the laboratory /5-23/. A microscope was used to identify erosion mechanisms. Results verify theories of how flowing water affects the cohesive particle bonds. Greater understanding of the bonds between neighbouring particles is needed. This is related to a general rheological model for smectite-rich clays, which is a goal for the research within this area.

### 5.3.3.4 Effects of Gas

In measurements of gas conductivity in porous materials in routine tests, just as in the case of measurements of hydraulic conductivity, it is important that average values be obtained. If there is great variation in the pore system, actual rates will not be measured.

The microstructure in smectitic clay can cause great variation in the pore system. Gas conductivity is dependent on whether the composite system of clay mineral and water is able to form a continuous pore system for penetrating gas, which is also dependent on the pressure conditions and gas flow. Earlier measurements of gas transport through SFR buffers /5-24/ showed that a critical gas pressure constituted a characteristic material parameter that is primarily determined by the density and homogeneity of the smectite component, that gas penetration takes place in a very limited number of passages, that the quantity of water displaced during buildup to critical gas pressure and gas breakthrough constitutes a small fraction of total pore volumes, and that breakthrough only occurs when the gas pressure is equal to the sum of the critical gas pressure and the prevailing water pressure.

A model has been proposed /5-25/, for the purpose of demonstrating the importance of density for gas and water flow in the density range between highly compacted Na bentonite and the looser state that exists in clay/aggregate mixtures. This model will be verified or refined in the continued research work.

### **5.3.3.5 Sealing Measures in Boreholes and Shafts**

The international collaboration at Stripa has permitted tests in a realistic environment of sealing measures in boreholes and in simulated shafts and tunnels /5-26,27,28/. It has been found that sealing measures in the rock around deposition holes and plugs in shafts can possibly be carried out even in relatively impervious rock with developed technology /5-29/. Tests with such technology are included in Stripa phase 3. In an initial stage /5-30/, both bentonite- and cement-based materials have been chosen for continued tests in the Stripa mine.

Borehole and shaft sealing measures require great attention in the programme for development of the KBS-3 type disposal method with several shafts to storage caverns at a depth of about 500 m spread out over an area of a square kilometre or so. In order to obtain good sealing results, a developed methodology is also required for quality description of surrounding rock so that the sealing measures can be carried out with good strategy and taking into account the geohydrological conditions. It is of great importance to be able to characterize conductive conditions in the rock in the near field so that its interconnection with other preferential water paths in the rock is obtained. An initial analysis has been made of a process for quality description of the rock in the repository's near field and its interconnection with fracture zones of geohydrological importance in the rock. Stripa and the Hard Rock Laboratory are potential testing grounds for such method development.

### **5.3.3.6 Model Development for the Barrier Function**

SKI assumes that development of models describing processes of importance during and after deposition will take place in close cooperation with groups who are studying different sub-areas. As noted above, mechanical model development is being pursued in close cooperation. The same group is devising the material model and calculating and performing validation tests.

For studies of migration of radionuclides, TVO and VTT in Finland are collaborating with SKB and Clay Technology AB in measuring diffusion and interpreting its premises with the available material model.

As was evident from the section on long-term stability, 5.3.3.1, a model for the chemical stability of the buffer is being developed in direct association with the study

of clays. Other chemical aspects of this model development are being studied in other groups.

The development of a model for radionuclide migration coupled with groundwater flow in rock, a model for canister corrosion and a model for fuel dissolution have to do with chemical conditions and are described in other sections of the research programme.

### **5.3.3.7 QA Programme**

IAEA says that attention must be given to quality assurance when it comes to buffer and backfill materials, and recommends that higher priority be given to QA in connection with such research in the future (early 1990s).

As was evident from the section on sealing measures, 5.3.3.5, confidence in the description of rock quality is important, in particular when describing the connection between the sealing materials and the rock in terms that define the premises for how its function can be expected to be during a long period after emplacement. Attention has been given to the question in connection with the development of methods for sealing of rock in Stripa phase 3.

### **5.3.3.8 Summary of Research Results**

#### **Description of engineered barrier, buffer material with respect to transport conditions**

The properties that characterize transport conditions through the buffer material are low hydraulic conductivity and low diffusivity.

Hydraulic conductivity is primarily determined by density and smectite content, see Figure 5-6. A selection of well-defined clays has been compared with the reference clay in KBS-3, Mx 80, a clay of the Wyoming type with mainly sodium as the adsorbed ion. The comparison shows that with no reduction in density, hydraulic conductivity is low even if the smectite content decreases /5-31/. The smectite content of the buffer material can decrease as a result of transformation of smectite to illite at a rate dependent on the temperature. A greater understanding of the relationship between microstructure and temperature, obtained through studies of clays in hydrothermal tests, has led to a more nuanced model for temperature effects /5-19/. The model has been tested in the study of natural bentonites. An important contribution has been the Gotland bentonite located at a depth of about 500 m at Hamra. According to the model, a critical temperature is 150°C. Below 105°C, insignificant changes occur due to a slow reaction of the Arrhenius type. In the interval 105°C to 150°C, permanent changes can occur of importance for microstructure, but illite/smectite mixed layer formation is insignificant or non-existent. The conclusion is that temperatures of 105°C to 120°C are pos-

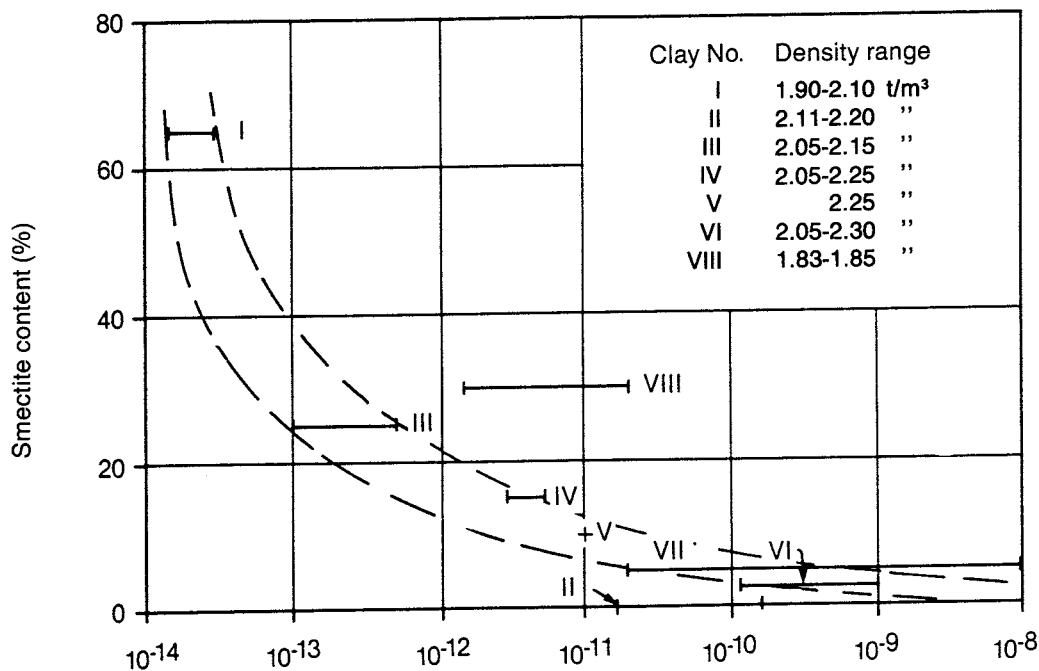

Figure 5-6. Hydraulic conductivity/smectite content for eight clays. Smectite content is shown here as a percentage of the total quantity. The width of the area marked in the figure represents the variation of hydraulic conductivity in smectite clays with a density of at least 2.0 t/m<sup>3</sup> at water saturation.

sible in deposition holes in compact bentonite without mineral changes being of importance for the barrier function.

A survey of Swedish buffer material candidates has been carried out, whereby a developed technique for quantitative XRD analysis (Reynolds) has been tested. The technique enables the fraction of constituent clay minerals in a sample to be determined with an accuracy of  $\pm 10\%$ . The survey did not reveal any major deposits of Swedish materials for buffer in deposition holes, but did find material for backfill /5-32/.

### Description of engineered barrier, buffer material with respect to mechanical conditions

The buffer material is supposed to interact with the rock and the canister so that a suitable environment is obtained for the canister. Accordingly, the canister is supposed to be borne up by the material in the deposition hole and protected from unfavourable stresses or possible movements deriving from the rock.

Bentonite can be deformed and change its volume through redistribution, absorption or emission of water. The water in highly compacted bentonite comprises approximately one-quarter of the volume, and the physical state of the bentonite varies depending on the clay

mineral and the microstructure. The variation in density has been measured and discussed over a long period of time and indirect measurements using several methods have been used. Examples are NMR, which has been tried for many years in the SKB research programme in an attempt to reveal the nature of the interaction between the clay mineral and water /5-18/.

A model for the physical state of water in different parts of the microstructure, see Figure 5-7, is of importance to obtain a theory for the rheology to be applied in the formulation of the material model and to permit extrapolation of conditions over a long period of time, for example for creep, see sections 5.3.3.3 and /5-33/.

Rheological properties of bentonites have been measured /5-34, 35/. The settlement (subsidence) of a simulated canister in a deposition hole was studied in the laboratory, see Figure 5-5, during the period April '85 – December '86, and observations are being made at Stripa, in both cases with temperature variations.

Shear tests with models simulating canisters in deposition holes have been carried out /5-36/.

Mathematical models with FEM have been used for comparisons /5-37/. They show that it is possible to model rate and temperature dependence in more or less dynamic processes such as thermomechanically or tectonically induced shear deformations or settlements of canisters.

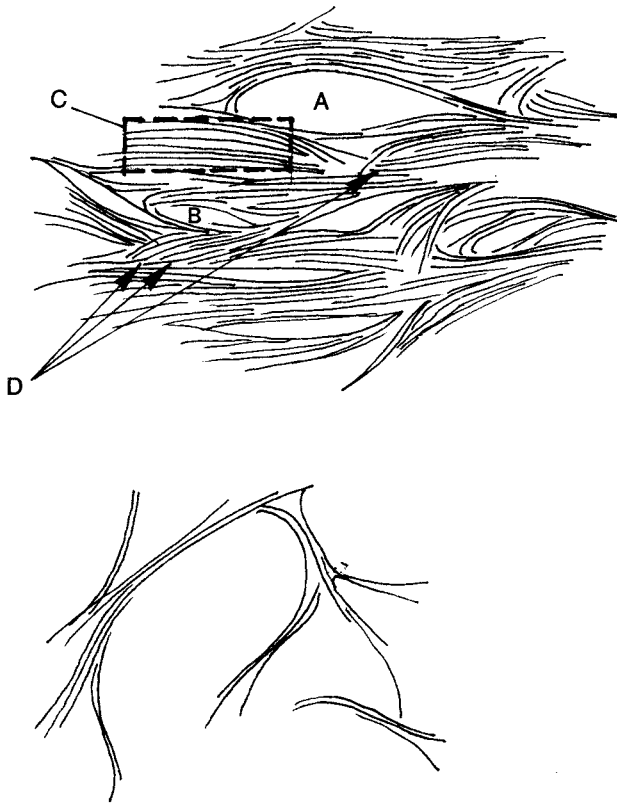

Figure 5-7.

TOP: Compact sodium montmorillonite clay

A) Large pore

B) Little space with external water

C) Stack or quasicrystal with organized interlaminar water

D) Contact between stacks

BOTTOM: Swelled sodium montmorillonite gel with very thin stacks and almost only external water.

### Description of Backfill and other Sealing Measures

Attempts to reduce the water flux in the near field of the waste outside the buffer include backfilling with impervious materials in rock chambers and sealing of fractures in surrounding rock. The lower part of the disposal tunnels can be backfilled using currently known methods and equipment. Experience from Stripa, where backfill with 10–20% bentonite mixed with aggregate has been used /5-22/, has shown that a compacting method and equipment for the upper part of the disposal tunnels can be developed. The test showed that water absorption took place with low water pressures in the near field in the surrounding rock despite relatively high pressures further out in the rock. The backfill filled out the tunnel completely, but the degree of compaction can be increased with a refined method for the application of fill in the upper part of the tunnel. Plug-

ging of shafts, boreholes and tunnels /5-26,27,28/ was also tested. Experience from these tests has led to experiments with the sealing of rock fractures in a third phase at Stripa. The rock surrounding the BMT drift is planned to be sealed in stages so that its hydraulic conductivity is reduced in a measurable fashion. Of particular interest is obtaining data on the disturbed zone surrounding the tunnel so that blasting effects and stress redistribution effects can be distinguished, if possible. Theory and experiential data may indicate that conductivity is several orders of magnitude higher along the tunnel than in the radial flow direction. Sealing measures in the rock surrounding deposition holes are being tested, as well as sealing in a natural fracture zone.

The measures are to be regarded as examples of sealing measures intended to be included in a strategy that redirects the flow of water away from the near field of the waste. It presumes knowledge of the pattern of more conductive zones that communicate with the near field and the size of more impervious intervening rock volumes, see Chapter 6.

The research includes laboratory tests and analysis of long-term stabilities of the sealing materials based on cement and bentonite.

### 5.3.4 Research Programme 1990–1995

The research on the relationships between the microstructure of clays and factors of importance for transport in buffer materials will continue. The studies will also be broadened to include mixtures with natural material and crushed rock with the goal of presenting material models for

- water flow,
- diffusion,
- heat conduction,
- behaviour in the interface with mobile water in rock fractures.

Rheological properties will be tested in the laboratory for buffer and backfill materials for material models to be used in theoretical modelling for

- thermomechanics,
- creep,
- shear deformation,
- swelling, compression, homogenization,
- rock fracture sealing.

The research will include development of methods for quality assurance based on characterization of materials and their interaction with the canister and the rock.

The R&D-programme includes development of compaction methods for backfill material in the upper part of the storage tunnels with the goal of identifying how the methods themselves can influence the isolating properties of the backfill. A proposal for a method for use on field scale is being prepared and will serve as a basis for the development of equipment and later practical tests in a simulated repository environment.

## 6 PROPERTIES OF THE ROCK

### 6.1 GENERAL

#### 6.1.1 The Role of the Rock in the Final Repository

The rock is a prerequisite for a safe final disposal of spent nuclear fuel in accordance with the principle developed in Sweden and many other countries. The rock has a number of fundamental properties that are exploited for the long-term safety of the repository.

Important fundamental functions are:

- mechanical protection,
- chemically stable environment,
- slow and stable water flux.

The rock provides a long-lasting mechanical protection against external forces, including human intrusion. A final repository in rock also provides good protection against changes in climate. Climatic changes can lead to an altered biosphere, a considerable increase in sea level, or can alternatively give rise to permafrost and glaciation. The impact of such changes will be minimized if a final repository is located in deep geological formations.

Of fundamental importance is that the chemical environment be stable. The reducing chemistry of the groundwater is of great importance for the service-life of the canister and for the slow dissolution of the fuel matrix. The chemistry is determined for the most part by the mineral composition of the rock, which is stable over very long periods of time. The chemical environment of the rock is also important in determining how radionuclides can be transported. Here, the interaction between nuclides and rock is of importance. These properties are largely associated with the rock matrix, which does not change appreciably through the eons.

The low groundwater flux in the rock is of importance both for the stability of the barriers and for the slow transport of nuclides in the rock. The water flux is governed largely by the topography of the ground surface, by the fractures of the rock and by prevailing rock stresses. These factors are all stable by nature. The groundwater flux around a repository will therefore not change appreciably with time.

For an assessment of the performance of the final repository, it is necessary to describe the components of the repository and their interaction over long periods of time. Since it is difficult to clarify how this long-term interaction takes place on a specific site, theoretical models are used.

The extent to which the models used are valid is of fundamental importance for the assessment. Models of

the rock have specific peculiarities, which are discussed in greater detail in section 6.3.2. The rock is opaque and large volumes of a complex, heterogeneous medium have to be described. The description is often based on a large number of point data from boreholes that are then generalized to various scales according to the specific problem to be analyzed.

Certain interactions in a repository are only affected by a few of the rock's parameters. Calculating the canisters service-life, for example, requires only data on local groundwater flux and chemistry.

Describing how nuclides are fixed and transported in the rock requires more information. The groundwater's flow distribution must be described over large volumes. Different models are employed by different groups of researchers. Some models describe flow in individual fractures, putting high demands on data collection. Other models assume flow in a porous, partially homogeneous medium, which is much too rough an approximation in many applications.

It is an urgent task of current research to test the validity and limitations of these models.

#### 6.1.2 Investigation of Rock

Investigations of rock for final repositories are carried out in stages which become progressively more detailed and whose content is progressively adapted to the needs and the information that emerge in the investigations.

It is fruitful to carry out and present the investigations on different scales. A rough classification that is used here, see Figure 6-1, is

- regional scale, 1–10 km,
- site scale, far field, 100–1000 m,
- block scale, far/near field, 10–100 m,
- site scale, near field, 0–10 m.

The near field is usually defined as the area nearest the waste that could conceivably be affected by the waste or by the excavation of rock; a small temperature increase is not included. The size of the near field is dependent on the configuration of the final repository. In some configurations, it is possible to have a near field for each waste package.

The fundamental functions can be studied for each scale. This involves setting-up of a descriptive model, groundwater flow and chemistry, transport of solutes and mechanical stability.

It is urgent that the rock investigations for a final repository be conducted in a given sequence:

# Site investigations of rock for design and assessment of safety

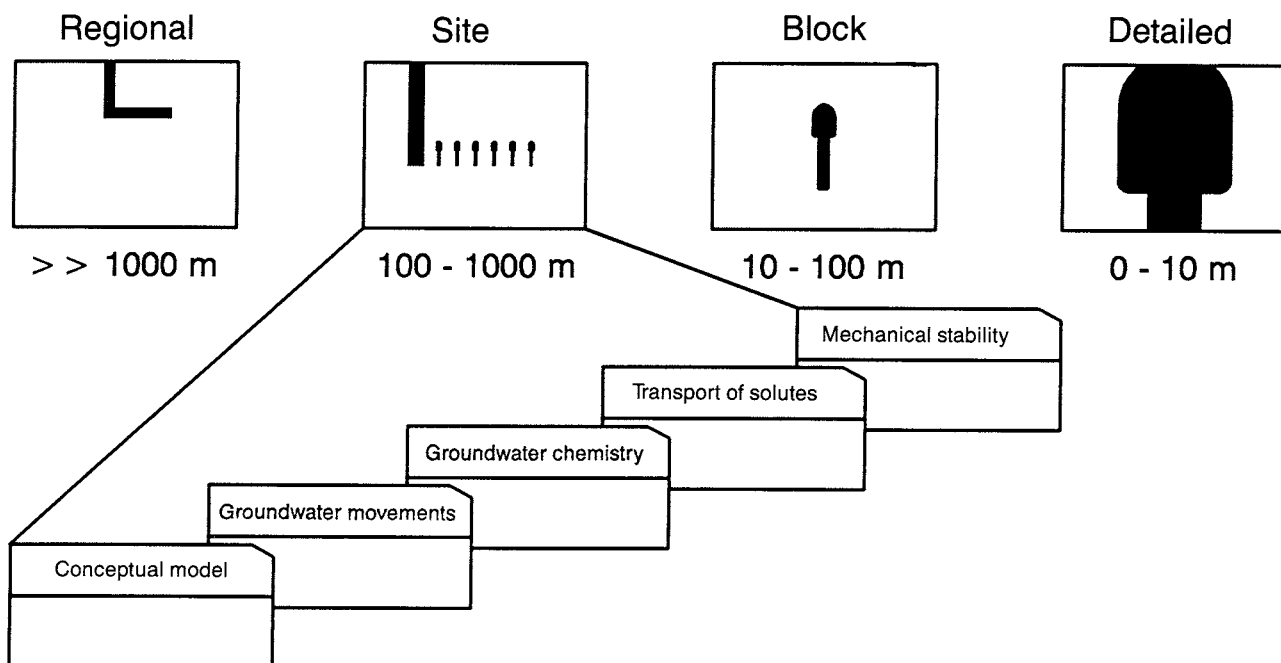

Figure 6-1. Research areas and scales.

- observations (data),
- processing of observations to set up a conceptual model over the area (structures and physical processes),
- calculations,
- evaluation.

This sequence is gradually carried toward a higher degree of detail as the information is improved in each investigation stage.

The different investigation stages are supposed to describe:

- groundwater flux,
- geometry and properties of the groundwater conductors,
- groundwater chemistry.

The investigations shall designate which volumes are of interest for continued detailed investigations. Volumes of interest for repository emplacement shall be specified. Furthermore, those volumes that will later have to be characterized between the repository and the discharge areas shall be defined.

The investigations shall provide background material for the geometric layout of the repository. Aims for the layout of the repository are:

- low groundwater flux in the repository's near zone,
- "respect distance" to potential zones of future rock movement.

The final repository should be progressively adapted and modified, leaving a large potential for flexibility.

## 6.2 GROUNDWATER MOVEMENTS IN THE ROCK

### 6.2.1 Goals of the R&D Activities 1990–1995

The main goals of the research on groundwater movements in the rock are to:

- further develop and test methods for location and characterization of fracture zones and water-bearing fractures,
- broaden the database for water-bearing fractures and fracture zones with the data needed in models,
- further develop models that describe the groundwater flow pattern in the rock,
- test the usefulness of different models and the reliability of the calculation results.

Much of this research is being carried out within the framework of the Hard Rock Laboratory, see further chapter 9. For the period 1990–1995, the following sub-goals can be mentioned:

- to evaluate the results of Phase 3 of the Stripa Project in order to specifically decide whether further experiments are needed to characterize the so-called “disturbed zone”, to evaluate tracer technique in underground facilities and to evaluate the usefulness of numerical fracture network models,
- to evaluate the tracer tests at Finnsjön to specifically decide to what extent the technique used provides material for calculation of transport of radionuclides in fracture zones,
- to set up programmes for the pre-investigations, calculations and reports that are to be carried out on the candidate sites,
- to set up programmes for the detailed investigations that are to be carried out.

## 6.2.2 Present-day State of Knowledge

The movements of the groundwater are of importance for describing the performance and safety of the final repository.

In order to carry out a credible analysis of groundwater movements, a good description is required of the physical media in which flow takes place. Furthermore, the theories used must relate to the way in which the flow takes place physically in the medium. There are practical (and economic) limits here on how long the description can be carried in the different investigation stages.

It is also important to describe how models can be set up and validated with the data available in different investigation stages. Models are set up with different basic premises and can be applied on different scales, which governs which data are to be collected and how they are to be evaluated. Validation of the models thereby also requires experiments on different scales.

There are only a few facilities in rock today where the entire chain investigations – calculations – evaluation of groundwater flowpaths has been carried out and documented.

Observations and data on the rock and on groundwater movements in the rock need to be processed and analyzed from different aspects. The most important of these are:

- available rock volumes of a certain quality,
- presence of flowpaths,
- data for repository layout on different scales,
- data for analysis of groundwater flux on different scales,
- description of the water’s flowpaths in the repository area and its environs.

### 6.2.2.1 Observation Methods for Groundwater in Rock

The present-day state of knowledge regarding the collection of relevant data in the field to describe groundwater movements is outlined in this section. In order to tie in with natural investigation stages, the relevant methods are described under the headings:

- surface investigations,
- borehole investigations,
- underground studies.

Investigation methodology and instruments are described in detail in section 8.2.

## SURFACE INVESTIGATIONS

Surface investigations include geological mappings, as well as airborne and ground geophysical surveys. Unfortunately, it is generally difficult from existing material from investigations in Swedish bedrock to draw unequivocal conclusions on the applicability and limitations of the methods. Furthermore, the value of different methods varies for different sites. In order to evaluate the limitations of different methods on a chosen site, predictions must be made. These predictions can then be checked by the use of other, independent surface investigation methods for the purpose of verification. Other ways to check the predictions are borehole investigations or investigations from tunnels. Surface investigations normally provide a very good coverage of the ground surface, but it is difficult to utilize this surface information for preparing three-dimensional descriptions.

The geological mapping that is carried out in Sweden through the Geological Survey of Sweden shows eg rock type distribution and tectonics in the ground surface. For engineering purposes /6-1/, however, it is recommended that three-dimensional descriptions of the bedrock be performed in the form of predictions. The importance of making these predictions in stages is also emphasized.

This strategy is applied consistently for the investigations in the Hard Rock Laboratory, where predictions are prepared on a number of scales. This makes it possible to judge the value of the results from surface investigations in the light of continued investigations. The first stage in the investigations has been presented /6-2/.

A large number of surface investigation methods have been utilized to provide an aggregate regional picture of geology, geohydrology and groundwater chemistry. In the continued investigations, it will be possible to compare these predictions with results from deep boreholes and from tunnels.

An important part of a rock description is to indicate the rock type distribution, since the rock type influences the chemistry of the groundwater, permeability and structures /6-2/.



Geological mapping provides a good description of the rock type distribution in the ground surface. The regional mapping is facilitated by airborne geophysical surveys. For the Hard Rock Laboratory, the magnetic and electrical properties of the rock, as well as bedrock radiation, were measured. The connection between geophysical indications and rock type was then confirmed by mapping and petrographic investigations. The geological/geophysical interpretation also indicated the depth to which the rock types extended (diapirs). Supplementary gravitational measurements were carried out and interpreted, showing that younger (and lighter) granites were present at a depth of a kilometre or so below the ground surface. The geological mapping and applied geophysics thereby enable a three-dimensional rock type distribution to be described on a regional scale.

The detailed investigations of southern Äspö showed that surface investigations are of limited value for describing the rock type distribution in depth. Data from the drillings showed an unexpected occurrence of a quartz-poorer variety of rock – diorite – at a depth of about 300 m. It is possible that detailed gravimetry can be utilized to shed light on possible rock type variations in three dimensions.

Another important part of the rock description is to describe the zones of weakness of the bedrock. Mapping provides a good means of describing the geometric distribution of steeply-dipping structures in the bedrock. Mapping is facilitated and can be supplemented by information from eg aerial photography interpretation, geophysics, topographical analysis etc. It is often difficult to describe the character of the zones in mapping if the area is not completely exposed. Of great value is the opportunity to expose geological profiles, in a similar manner as was done over Äspö in connection with the investigations for the Hard Rock Laboratory /6-3/. As far as the subhorizontal structures of the bedrock are concerned, a careful mapping and interpretation can also contribute towards describing these /6-4,5/.

The National Land Survey Administration's digital database was utilized to perform tectonic interpretations. Study of the topography reveals lineaments, especially vertical structures. The length, width and direction of the lineaments can be utilized to describe zones of weakness. Zones, however, can have widely differing characters that cannot be discovered on maps.

Magnetic and electrical methods are used routinely to map the zones in the bedrock. In general, however, their range is limited to a 100 metres. Simultaneous interpretation of several methods in parallel provides indications of the dip of zones.

Also of interest here is the evaluation of geology and geophysics that was carried out in conjunction with the construction of the 80 km long Bolmen Tunnel in southern Sweden /6-6/. Mapping carried out in conjunction with the tunnelling work could be compared with the geological and geophysical description prepared

before and during the construction work. The following was found:

- airborne magnetic surveys indicated 80% of all zones over 50 m in width, but only 25% of zones less than 50 m in width,
- ground geophysics (VLF and Slingram) indicated 80% of all zones over 50 m and 60% of narrower zones,
- resistivity measurements indicated 95% of all zones over 50 m in width and 80% of zones less than 10 m in width,
- refraction seismics indicated 60% of the zones over 50 m in width and 13% of the most pronounced zones with widths less than 10 m.

It was found that a combination of geophysical methods is often necessary to prepare a good description. Furthermore, it is difficult – with the chosen distance between measuring points in profiles – to detect zones of less than 10 m and zones that are subhorizontal. Predictions of the presence of water in rock could not be made merely on the basis of geophysical investigations.

A geophysical method that has had limited application in Sweden is shallow reflection seismics. Analyses of reflection seismic surveys have been reported in /6-7/ and /6-3/. In order to obtain a good description of the uppermost 100 metres, time resolution and apparatus need to be better than those used in these surveys. In /6-8/, for example, the resolution of 0.25 ms is to be compared with 0.5 ms for the surveys on Äspö. Reflection seismic surveys for URL in Canada soon revealed Fraction Zone 2. This technique is well worthwhile for further surface investigations, since it provides volume information while at the same time permitting the subhorizontal zones to be detected, which can be difficult to detect with other methods. In the approximately 7 km deep boreholes that were drilled at Siljan to test the deep-gas theory, the reflection seismic surveys were of great value.

With dense reflection seismic profiles, it is deemed possible to achieve a good geological model in three dimensions. Such surveys can be carried out relatively easily even for areas under water.

### Summary Evaluation

Surface investigations provide the basis for an initial geological interpretation of a site.

It is of value that surface investigations be carried out in parallel with different methods and that the investigations be evaluated progressively, in stages. It is difficult today owing to limited documentation – to generally evaluate what surface investigations yield in relation to borehole investigations. It must also be stressed that surface investigations should be site-optimized, since different methods are suitable for different sites. It is essential that all material – geological, geophysical, geo-

hydrological and geohydrochemical – be co-interpreted in stages.

The difficulty of establishing the true scope of sub-horizontal structures must be particularly borne in mind. Surface descriptions constitute the basis for the setting-out of boreholes and thereby also provide the basis for interpreting the data that are later obtained from borehole measurements.

## **BOREHOLE INVESTIGATIONS**

Borehole investigations provide information that supplements surface investigations. As far as geology and geophysics are concerned, basically the same methods are used for both surface and borehole investigations. The boreholes can also be used for measurements between several holes to obtain a volume description of the rock, known as cross-hole measurements. In relation to the repository volume, the number of boreholes is very limited. In the French waste programme /6-9/, for example, it is emphasized that the number of investigation holes from the surface must be limited to a minimum.

### Cross-hole Measurements

Cross-hole measurements are carried out in order to determine the extent of zones of weakness between boreholes or to obtain average values for the properties of the rock between the boreholes. Different methods are used. The most common are hydraulic cross-hole measurements, where hydraulic response (pressure propagation) is analyzed. These measurements are often combined with tracer tests, where different tracers are injected into a borehole and water samples are taken from nearby holes. Cross-hole measurements are also performed using seismic and electrical (radar) methods.

### *Interference Measurements*

Hydraulic cross-hole measurements (interference measurements) are performed to obtain information on hydraulic interconnections in the rock mass.

Evaluation of the measurements provides values for the transmissivity of the flowpaths, as well as information on their geometric extent. Cross-hole measurements have been carried out both within the framework of SKB's fracture zone project at Finnsjön /6-10/ and for the Hard Rock Laboratory /6-3/. The measurement technique used has performed very satisfactorily, as has the evaluation of the results. Interference measurements have also been carried out as a part of the investigations for SFR /6-11/, where they made a substantial contribution toward increasing the understanding of the hydraulic interconnections around the final repository and toward averaging over large volumes.

### *Radar Measurements*

Borehole radar is described in greater detail in Chapter 8. The technique for radar measurements in the type of rock that exists in Sweden has been further developed within the framework of the international Stripa Project, see Chapter 10. Measurements with radar can be carried out either as reflection measurements or using tomographic analysis. Radar tomography requires high measurement density so that the area or the measuring plane between the boreholes is criss-crossed by a large number of measurement lines. Two types of tomograms can then be plotted from the data, representing the attenuation and the speed of propagation of the radar signal, respectively.

SKB has conducted two special method tests, one of which was a blind test where cross-hole radar, without access to other information, was supposed to be used to describe the properties of the rock. The method test was performed in connection with the boring of a tunnel in Stockholm from which the goodness of the prediction could be evaluated afterwards /6-12/. The radar predicted a large, flat zone that was subsequently penetrated by the tunnel. It turns out that the radar also identified a number of minor anomalies that were of no importance for tunnelling. The study also showed that the technique for evaluating tomograms has improved considerably over the course of a few years.

At Stripa, SKB has also tested a method with saline water injection in connection with radar measurement. This method is deemed to be of great future value. Since radar is sensitive to the resistivity of the medium, the difference between tomograms plotted before and after saline water injection could be used to identify those areas in the rock that were water-bearing. As a cross check, the saline water content in the boreholes was also recorded. Since the measurements were carried out in several boreholes with a suitable configuration, a 3-dimensional picture of the flowpaths was obtained /6-13/.

### *Cross-hole Seismics*

Within the Stripa Project, seismic borehole investigations have been further developed by /6-14,15/. For this method as well, the development has concerned cross-hole measurements with tomographic analysis.

Within Phase 2 of the Stripa Project, cross-hole measurements were performed on two scales: within a 200 m block and with up to 1000 metres between the boreholes. Measurements on the large scale, which were to be used to test 3-dimensional tomographic analysis, were not very successful. This is partially due to the fact that the borehole configuration was unsuitable. On the smaller scale, however, the results were more promising. The method is being further developed with respect to the transmitter equipment, among other things, see also Chapter 8.

Vertical Seismic Profiling (VSP) is another seismic method where measurements are made from points on the ground surface at different distances and directions around the borehole to a receiver in the borehole. This method has not been tested within the SKB programme.

### Single-hole Measurements

#### *Core Mapping*

The drill core can be mapped with great accuracy with respect to rock type, fracture character, fracture-filling material etc. Of great importance is the analysis of the fracture mineral, which provides a means of estimating a relative age for different groundwater periods. It is, for example, possible to describe when calcite sealing took place, cf Chapter 7 and /6-3,6-16,17/.

#### *Geophysics*

Geophysical loggings of boreholes by means of several methods complement each other so that several coincident anomalies are utilized to describe the rock mass. Systematic studies have been performed to correlate logging results with, for example, hydraulic parameters /6-84/ or to study correlations between radar anomalies and other borehole information /6-18/. Systematic correlations have also been carried out for the Hard Rock Laboratory /6-3/.

Statistical processing of correlations between different types of data has begun. There is no single geophysical method that clearly and consistently correlates with hydraulic conductivity or hydraulic fracture frequency. The results in /6-84/ indicate that hydraulic conductivity can be predicted with relatively few data from the borehole. Highly conductive zones are indicated by a combination of low resistivity (single point resistance) and long pulse times (sonic). These zones often coincide with increased fracturing, crushed rock and iron precipitations in fractures. Within the Klipperås study site, the subhorizontal zones appear to be the most conductive.

In one study /6-18/, the radar signals from measurements at Klipperås, Finnsjön, the Saltsjö Tunnel, Ävrö and Stripa were evaluated and correlated against other borehole information. The study shows that there is a good correlation between high radar intensity and fracturing in the rock mass. The correlation between radar intensity and hydraulic conductivity is good for the measurements at Stripa, but not for the other sites. It is also evident that there are hydraulic units in the rock mass that are not detected by means of the radar method. Radar indicates potentially conductive zones. What is valuable about radar is that it is a volume-descriptive method that shows structural (geometric) characteristics in the rock mass far out from the borehole – up to 150 m with present-day equipment. Resolution is dependent on the measuring frequency selected.

Of particular interest is being able to determine the orientation of fractures in the borehole. Here a so-called “televiewer” seems to be appropriate, see further Chapter 8.

#### *Hydraulic Measurements*

In order to determine the transmissivity of the rock, water injection measurements are performed between packer seals in boreholes. The packers are usually spaced at distances of from 20–30 m down to 2–3 m, but in special studies /6-10/ spacings of down to 0.11 m have been used. With refined evaluation technique /6-3/, the evaluation limit can be as low as  $10^{-12}$  m/s for a 3 m packer spacing. It is very important that the evaluation of the hydraulic conductivity should take into account the scale on which the measurements are performed. Most of the measurements are performed on a scale that is below the Representative Elementary Volume (REV), ie the minimum size for which the approximation with a porous medium assumption can be used. The packer spacing is important, since it is not possible to describe the spacial variation of the logarithm of the conductivity in the borehole on scales smaller than the packer spacing /6-19/, unless the transmissivity distribution can be linked to other information from the borehole /6-20/.

Within the framework of the bilateral agreement between US DOE and SKB, data from study-site investigations have been used to provide recommendations for optimal packer spacing /6-20/. It is recommended that short packer spacings – just a few times greater than the average fracture spacing – be used.

In the investigations for the Hard Rock Laboratory, a new type of measurement has been introduced for measuring hydraulic conductivity /6-3/. Flow logging has been carried out in deep cored holes in connection with test pumping of the holes. The vertical water flow is measured along the entire hole under the pump, enabling the water-bearing sections to be detected. Measurements are carried out for a 1000 m long borehole in a few hours. A measurement is performed for each metre, and the transmissivity of the most conductive zones is calculated. Furthermore, a unique series of measurements with different packer spacings has been carried out to shed light on average conductivity and variance on different scales.

#### *Flow Measurements*

Of great value for an understanding of groundwater movements is the ability to carry out direct measurements of the groundwater flow. A special instrument, a dilution probe, has been developed for this purpose. Measurements have been carried out at Finnsjön /6-10/. This type of measurement is deemed to be of great importance, since it provides a means for direct comparison between calculated and measured values of water flux.

### *Hydraulic Pressure*

Measurement of groundwater head is essential in order to understand the driving forces for the groundwater. Pressure measurements were of crucial importance for how the numerical models were utilized for SFR /6-21/. It is, however, tricky to evaluate pressure when the density of the water varies, and the results have to be adjusted for this. This is essential if pressure measurements are used to validate calculation models for groundwater.

### *Rock Stress Measurements*

Stress measurements have been carried out to correlate hydraulic conductivity with stress levels and to study whether the direction of the maximum principal stress coincides with anisotropies for the groundwater flow /6-3,6-10,6-17/.

Evaluating stress measurements is not a trivial matter. A large quantity of data has been evaluated under the cooperation agreement between AECL and SKB that was concluded for characterization of the 240 m level in URL, /6-22,23/. It turned out that the stress results were affected by such factors as tectonics, mineral grain size, microfissures and drilling technique. In the high stress field at the 240 m level, the main result was that measurements in boreholes with a large angle to the maximum principal stress direction tended to yield results with the maximum obtained principal stress oriented parallel to the borehole. It is believed that the problems can be identified by geological mapping of drill cores and by parameter checks. Geological mapping is being concentrated on mineralogical inhomogeneities adjacent to the measuring cell, as well as structures such as foliation and visible microfissures. At URL, it was found to be difficult to interpret the measurement results if the volumetric strain exceeded 0.07% /6-22/.

### Summary Evaluation

Measurements in boreholes are based on advanced technology and are resource-demanding. In order to permit subsequent evaluation, several independent methods must be used. It is difficult today to determine the specific benefit of an individual method. It is judged that borehole measurements and surface investigations together provide sufficient information to carry out a preliminary evaluation of the performance and geometric layout of the repository and to identify suitable rock volumes for detailed characterization.

## **INVESTIGATIONS IN TUNNELS AND SHAFTS**

Detailed investigations and construction of a final repository entail the construction of tunnels and shafts. It is of primary interest to make use of these tunnels and shafts to make observations of the bedrock. In the same

way as for surface investigations, tunnels provide access to surfaces for observations. The generalized geological picture that is obtained from surface investigations and from point information in boreholes can be confirmed and complemented. As far as groundwater movements are concerned, the boreholes provide point information while tunnels provide an opportunity for more detailed analysis of how the water distributes itself geometrically in the bedrock. In connection with the construction of tunnels, pressure responses in surrounding boreholes can be successively evaluated and compared with the evaluation previously made on the basis of surface and borehole information. The seepage that takes place into the tunnel is of interest in evaluating the validity of models for groundwater movements. The total seepage quantity can be utilized to calibrate the total groundwater flux in the area. The geometric distribution of the groundwater can be used to describe the flowpaths. It is also possible to collect samples of the chemistry of the groundwater in a tunnel. Comparison between chemistry results at different points in space and time facilitates the interpretation of groundwater movements.

A theoretical study describing how a tunnel can be utilized to gather data on the near field during repository construction has been published /6-24/.

### Groundwater Distribution

Both two- and three dimensional tracer tests have been carried out within the Stripa Project to shed light on the movement of the groundwater in the rock mass. The fundamental two-dimensional tests in a single fracture demonstrated the uneven distribution of the water over the fracture plane. The flow in the fracture plane can be described in simplified terms as taking place in flow channels formed as a result of the irregular profile of the two fracture faces /6-25,26/.

The three-dimensional tests were conducted in a relatively large volume of the rock mass. Different types of tracers were injected from boreholes 10–55 metres up from the drift to which they were expected to flow. The quantity of tracer collected in the drift varied from tens of percent of the injected quantity to thousandths of a percent. Four of the nine types of injected tracers were never recovered in the collection drift /6-27/. The experiments confirmed the channelling phenomenon. The other results have proved to be difficult to interpret, however, and no satisfactory explanations have been reported.

The results of the Stripa tests show that for tracer tests in tunnels, it is necessary to characterize the test area thoroughly. Flow takes place in the direction of the gradient only if the conductivity is isotropic. Accordingly, it is necessary to take anisotropy into account to describe the direction of the flow, since there are individual fracture planes in the near field of a tunnel that can control the flow. This experience will be built on in the design of future tracer tests.

Tunnel observations were also of some importance for the safety assessment of SFR /6-28/. The assumption of a high “channelling” in the bedrock could not be ruled out. Input data to the assessment were obtained by mapping the SFR tunnels with respect to the size of the seepage surfaces. It was assumed that the groundwater’s behaviour outside the tunnel corresponded to what was mapped in the form of seepage. Data from other studies /6-29/ were also utilized to support the model. Data from SFR, Stripa, Kymmen, the Saltsjö tunnel and from other facilities are currently being compiled. However, it is not yet clear what relevance these data have for interpreting the movements of the groundwater under natural conditions.

A tunnel gives rise to stress redistributions. These generally lead to a change in conductivity in the vicinity of the tunnel. Experience from SFR shows that conductivity across the tunnel decreases. It is a widely accepted view that axial conductivity increases. This is important in view of the fact that if nuclides leak to the “disturbed zone”, there is a greater chance of short circuiting between the tunnel and surrounding fracture zones. Few experiments have been conducted to study this effect. The buffer test at Stripa /6-30/ supports the view that the axial conductivity increases. The ongoing injection experiment at Stripa will furnish further data on axial conductivity, see Chapter 10. Besides stress redistributions, conductivity near the tunnel is affected by the blasting procedure, where the tunnel floor in particular is damaged by blasting. Other effects to take into consideration are the potential difference between the roof and the floor of the tunnel, and capillary effects.

Through cooperation with AECL in Canada, it has been possible to analyse one of the more well-documented experiments that shed light on how a tunnel is affected by the ambient rock mass /6-31/. AECL’s rock laboratory, URL, is situated in the Lac du Bonnet batholite, which has very few fractures. However, room 209 at the 240 level contains a single, highly conductive fracture that is crossed by a tunnel. Before the tunnel was built, holes were drilled parallel to it. The holes were instrumented so that changes in water pressure, transmissivity, rock stresses and rock deformations could be monitored during the blasting of the tunnel. The results show that the hydraulic conductivity across the tunnel has changed. The change varies over the periphery of the tunnel in such a manner that conductivity has decreased in the roof and walls, but increased in the tunnel floor. Since the fracture plane across the tunnel possessed very high stiffness, it has been concluded that the reduced conductivity in the roof and walls stems from the fact that the flow is affected by unsaturated conditions and/or material transport into the fracture. The increased conductivity in the floor of the tunnel is explained as an effect of blasting.

Tunnel tests have also been conducted at Hylte in connection with the instruction of a hydropower plant /6-32/. The studies have taken the form of experience gathering in preparation for the planning of the Hard

Rock Laboratory. This has included coordination of data collection and tunnel production. Geological mapping at the tunnel face, pilot drilling and hydraulic pressure buildup tests have been carried out for this purpose. Several different types of tracers have been tested. At present, qualitative tracer tests are in progress aimed at using UV light to test a technique for optical recording of tracer breakthrough in tunnels.

### Summary Evaluation

Data from tunnels are already being used for assessment of the repository’s performance and safety. The data collection method needs to be refined so that the information on eg pressure responses occurring during construction can be optimally exploited in the description of the site. The question of whether the data obtained during tunnel mapping etc are really representative of groundwater distribution under natural conditions requires further examination.

### **6.2.2.2 Conceptual Models**

The observations gathered from field measurements, in situ tests and laboratories need to be processed and generalized in conceptual models.

A conceptual model of, for example, groundwater flow consists of two submodels. One is the structural model, where the heterogeneities of the rock are defined geometrically. The definition includes volumes and/or surfaces and/or one-dimensional flow channels. Structural models can be set up on different scales with a relatively high accuracy, depending on available data.

The second submodel – the process model – describes which physical phenomena are applied to the structural submodel. The flow may, for example, be stochastic, saturated or unsaturated, take into account density contrasts in the water, thermal convection etc.

Since design and analysis proceed in stages and on varying scales, it is very helpful to set up these conceptual models on different scales. At present, there are several alternatives where each conceptual model imposes different demands on parameters and data.

The conceptual models are based in principal on laminar, viscous flow, but seek different ways to simplify the description of the fractures and cavities in the rock where groundwater movement takes place. Depending on data and needs, the conceptual models may be deterministic or stochastic.

The conceptual model also identifies the required data. For calculation of eg nuclide transport with the channel model, essential parameters are water flux, the length of the channels to the biosphere, diffusion of nuclides into the rock matrix, sorption of radionuclides on rock faces, the contact area in the flow channels between the flowing water containing radionuclides and the rock, the number of flow channels and the distribution of flow between the channels.

Most calculations are carried out assuming saturated flow and that the density of the water is independent of depth. In view of the fact that it has been shown that the salinity and density of the water increase with depth in the Swedish bedrock, these calculations are highly simplified and exaggerate the water flux in the bedrock. The calculation results can generally be verified by geochemical observations, flow observations or pressure observations.

Geochemical observations are preferable. The interface between the lighter, fresh water and the heavier, saline water provides a good means for checking the calculation results. The location of the interface is controlled by, and is extremely sensitive to, the regional groundwater situation. If good agreement is obtained between the geochemical and the calculated values, this is strong evidence that the model used is valid.

The interface shows that the driving forces to which the topography gives rise are short-circuited by sub-horizontal and subvertical zones. It is then of importance to study whether thermal convection can occur below the interface. Furthermore, it is of value to study the stability of the interface in order to see how the situation is altered by pressure changes, land uplift, assumption of conductivity distribution in the rock etc. Theoretical studies of the stability of the interface are included in the investigations for the Hard Rock Laboratory.

Flow observations have been made possible by SKB's dilution probe. The methodology is of great value for checking numerical calculations. Pressure observations are of limited value for validation of conceptual models if the calculation results relate to pressures at a depth of several hundred metres. The pressure differences are so small there that it is possible to use radically different geological models and still obtain good agreement /6-33/.

Conceptual models for groundwater flow in fractured rock can be classified in different ways, as mentioned previously.

Some of the conceptual models used are described in the following.

### Equivalent Porous Medium

In crystalline rock, the flow takes place preferably in the network of fractures in the rock. By disregarding the individual characteristics of the fractures and instead calculating a fictitious average value through the bedrock, the continuum concept can be utilized. This simplifies the mathematical description of the problem. A prerequisite for this averaging from the microscopic to the macroscopic scale to be valid is that the rock volume over which averaging takes place is larger than the Representative Elementary Volume (REV) /6-34/.

In view of the variation of transmissivity in the Swedish bedrock, it is estimated that several thousand water-bearing fractures are required to obtain stable

averages of conductivity, i.e. the average flow must be calculated over km<sup>3</sup> large rock volumes. From this viewpoint, it is reasonable to use the continuum assumption for studies of regional groundwater flow. It should be noted that many researchers are uncertain whether an REV exists at all.

This model has been used for calculations on a regional scale. They provide a general description of the inflow and outflow areas, a description of the water flux and the length of the flowpaths. They also give the boundary conditions for the smaller-scale calculations to be carried out later.

The regional calculations can be compared with flow observations. Sometimes, groundwater recharge is compared between measurement and calculation. This comparison provides some support for the calculation results, but is relatively controversial, since groundwater recharge in nature is difficult to establish. Important is the application of flow measurements in boreholes performed with a dilution probe.

An example of a successful measurement and interpretation is provided in /6-10/. In the subhorizontal zone at Finnsjön, the groundwater flow was measured across boreholes and compared with results from pressure and conductivity determinations, Fig 6-2. The flow measurement illustrates in a convincing manner the fact that subhorizontal zones can act as hydraulic barriers. Above the zone, the water is fresh. Below the zone, the water is saline and stagnant. The geochemical results show that the saline water is at least 7 000 years old, probably older.

The result is also supported by the theoretical numerical modelling of the interface that has been carried out, /6-3/.

The possible impact of the boundary conditions on the calculation results obtained in regional calculations has been discussed. An analysis was carried out for Klipperås /6-35/. For the calculated cases, the pressure distribution is relatively unaffected by assumptions of conductivity distribution. For a subregional three-dimensional calculation, the water flux and flow vectors were not affected by different assumptions of boundary conditions, nor was the pressure distribution.

Calculations with the conceptual model "equivalent porous medium" have above all been done with the computer program GWHRT /6-36/. This has been verified within the framework of HYDROCOIN /6-37,38,39/. The program was used in the safety assessments for KBS-3 and SFR. GWHRT uses the finite element method to solve the coupled problem with groundwater flow and heat transport in three dimensions. Pressure, flow and temperature distribution can be calculated, along with flowpaths for particles released from a given level.

For three-dimensional examples with realistic geometry, the number of calculation points is great, and limited computer resources have set a limit on the size of the calculations and parameter variations that can be done. The limit for model size is so far around 12 000 –

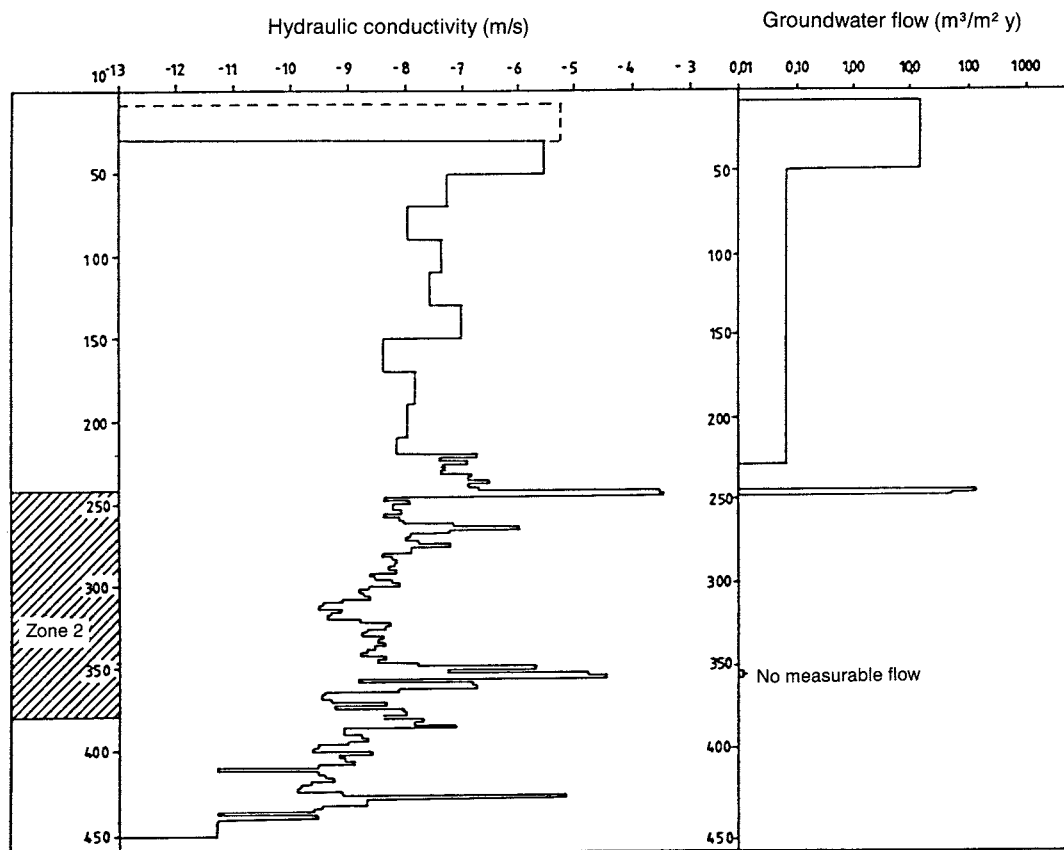

Figure 6-2. The left-hand portion of the figure shows results from measurements of permeability in borehole BFI 01 at Finnsjön. The borehole intersects the flat Zone 2. The right-hand portion of the figure shows the results from the flow probe. Below the zone the water is stagnant.

15 000 calculation nodes for a steady-state, non-coupled example.

The software package NAMMU will also be used for future analyses. NAMMU is a generally developed program for numerical calculation of groundwater flow, heat and nuclide transport in three dimensions. Extensive documentation is available in the form of both continuous program development and maintenance. What has been said above concerning output data and computer limitations for GWHRT also applies to NAMMU.

Like GWHRT, NAMMU has been verified with HYDROCOIN.

### Stochastic Continuum

It has been suggested /6-19/ that a stochastic continuum concept is a possible method for consistently and systematically describing groundwater flow and nuclide transport in rock. In this conceptual model, a statistical distribution of the hydraulic conductivity is assumed. The geometric situation of the conductivity in the model is stochastic. The method is interesting for describing the flow distribution of the groundwater, but it has not yet been clearly established whether the approach is adequate for describing the fixation and transport of

nuclides in the rock, since these are also controlled by chemical processes. The model has indirectly been used to study how the interface between fresh and saline water is affected by the spread in the hydraulic conductivity /6-3/. An interesting result is the fact that the variations in conductivity result in channels in the rock with high flows, while other units are stagnant. This flow distribution becomes more pronounced the greater the spread in conductivity is. Calculations have been carried out using a finite difference method, see Figure 6-3.

### Discrete Fracture Network Models

The possibility of describing groundwater flow with fracture network models is being tested within the Stripa Project. The properties of the individual fractures are simulated in these models. The models can be either deterministic or stochastic.

Using data from the three-dimensional tracer test in the Stripa Project /6-27/, network modelling has been tested to see if it can be used to describe and explain the distribution of the groundwater in a fractured rock mass /6-40/. The problem in network modelling, however, is the availability of relevant and adequate data on, for example, the extent and transmissivity of the fracture

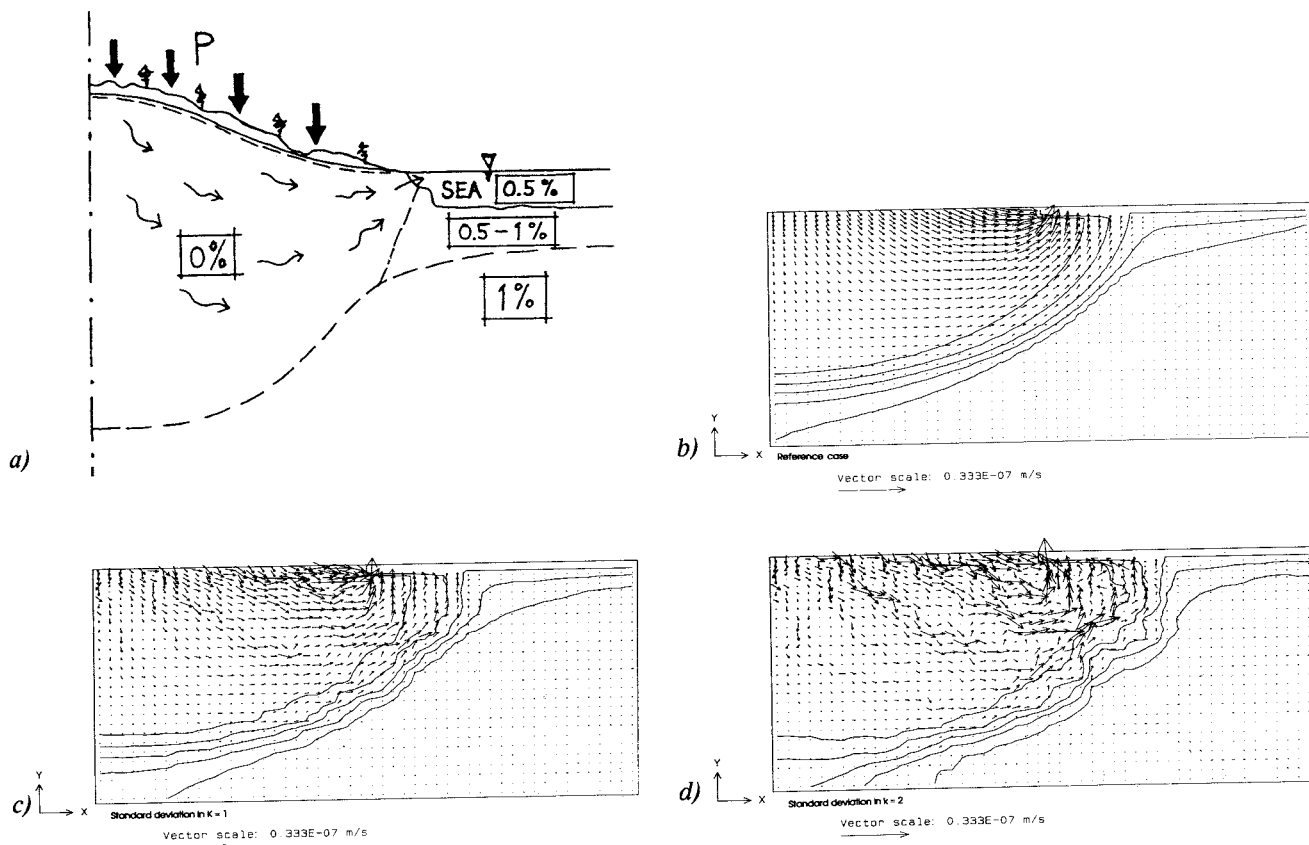

Figure 6-3. Calculations for studying the stability of the interface between the fresh and the more saline, heavier water encountered in coastal areas.

- a) Geohydrological situation. Salinity in %.
- b) Groundwater flow in a homogeneous medium.
- c) Groundwater flow in a medium where the hydraulic conductivity is stochastically distributed. Standard deviation  $\ln K = 1$ .
- d) For a more heterogeneous medium,  $\ln K = 2$ , the groundwater flow is concentrated to certain units. The interface becomes "crumpled".

plane. The work within the Stripa Project will help shed more light on the limitations of the calculation method and the requirements on input data.

Setting up network models on the basis of study-site data has also been tried /6-41/. It was possible to calibrate the injection measurements and the network model, but the calibration was insensitive to eg fracture length and fracture density, which are essential parameters for the network model. In order for network models to be used, measurements must be carried out to obtain a much better structural picture of the rock. It is not certain that this is possible. Furthermore, it is uncertain whether the physical description of the flow in the network models is relevant to nuclide transport. The fractures are modelled as parallel plates. The fracture opening between the parallel plates is calculated indirectly on the basis of packer measurements and/or tracer tests.

In contrast, the physical reality is that the flow takes place in portions of the fracture plane – channels – whose frequency and distribution is controlled by the direction and size of the gradient, among other things. Nor is it out of the question that most of the flow takes place in fracture intersections, which is also emphasized on structural geology grounds /6-3/.

A stochastic model that assumes that the fracture opening for an individual fracture varies has been tested /6-42/. The results show clearly that surface sorption and matrix diffusion have a great influence on the macrodispersivity in a fracture.

Different numerical calculations programs based on a discrete network model are being developed and optimized within the framework of the third phase of the Stripa Project. A description of a number of calculation models that are being used as well as of ongoing verifica-



tion exercises is provided in /6-43/. Two of the models are described in brief below.

NAPSAC is a three-dimensional network model that calculates the steady-state flow through a given rectangular block using the finite element method. The flow is assumed to take place exclusively through a network of fractures, and within these the flow is assumed to be linearly dependent on the pressure gradient. The model requires input data consisting of statistical distributions of the different parameters that describe the network. The calculations have to be repeated a large number of times for different realizations of the fracture network. Output data are the steady-state flow as well as the variation of the flow. The program is being developed for the Stripa Project by Harwell Laboratory in England /6-44/. Verification and validation will be carried out within this project. Limited computer resources set a limit on the utilization of this model today.

JINX stands for "Joints In Networks" and is a collective name of a number of computer programs /6-45,46/. JINX is also being used within Phase 3 of the Stripa Project. JINX consists of a PC-based graphic pre-processor for generation of fracture geometries and finite element networks, FRACMAN. MAFIC then calculates the steady-state or transient flow through the fracture network using the finite element method. Flow both through the fracture plane and through the rock matrix can be simulated. MAFIC can also be used to calculate nuclide transport along the flowpaths of the network. The programs are still under development.

#### Equivalent Discontinuum

The equivalent discontinuum model is something in between a stochastic continuum and a network model /6-43/. The model is being used in Stripa, Phase 3. Special automatic algorithms are used to generate a network that minimizes the discrepancy between model and measurement data. It is not possible for the actual network to be recreated. The model is interesting for studies of groundwater flow distribution. The approach is in the basic research stage and it is uncertain to what extent it can be used in the future for calculating nuclide transport.

#### Flow Channel Model

A highly simplified model for groundwater flow distribution in the bedrock is the flow channel model /6-28/. The input data for flow distribution comes mainly from data collected during tunnel mapping. The groundwater flow is very unevenly distributed in fracture zones and in fractures. The preferential flowpaths are not to be regarded as geometric properties, but are dependent on the gradient, the direction of the gradient and the local transmissivities in the fracture network, which has also been treated in numerical models /6-47/. Chemical transport is dependent not only on the flow distribution, but also on the chemical interaction between the solutes in the water and the surroundings. The

channel model is a highly simplified description of the groundwater's distribution and how nuclides are fixed and transported. The channels are alternatively regarded as being either independent or interconnected in points. In the latter case, mixing of water occurs.

Data for the flow channel model is obtained from tunnel mapping and assumes that such mapping gives a relevant statistical distribution of the groundwater's flowpaths. The extent to which this is the case requires further study.

#### Summary Evaluation

The conceptual models available today are able to describe water flux and flow distribution with sufficient accuracy to permit the preliminary layout of a final repository or the life of waste canisters to be evaluated, provided that data is obtained for the host rock (with existing methods).

The safety assessment of a final repository should include calculating how radionuclides are transported with the groundwater. This cannot be done today with the desired accuracy. It is impossible to say which models or combination of models best represent reality. It is therefore necessary to make use of pessimistic models that greatly exaggerate the transport.

The conceptual models that exist can be calibrated against experiments, but they are not particularly discriminating in relation to how the physical flow takes place in the rock. Tracer tests with non-sorbing and weakly sorbing tracers can be one possible way to distinguish the conceptual models. It has not yet been demonstrated that tracer tests make it possible to discriminate between different conceptual models. In recent years' safety assessments, SKB has used the flow channel model for calculating nuclide transport, since it offers the most conservative model for the function of the rock as a barrier.

It can be worth noting that UK/DOE has presented an overview of calculation models for groundwater movements and nuclide transport /6-48/. This report calls for further development of methods for modelling flow in fractured media and gas transport, and of geo-statistical methods.

#### **6.2.2.3 Validation of Models for Groundwater Movements**

How well models are able to describe reality is characterized by the concept of validity. The concept of validity is currently being discussed within several projects, see Section 3.3.6.

Within the framework of the Hard Rock Laboratory, work is also being done to define what validation of groundwater models entails and requires.

A computer model is a mathematical realization of the conceptual model within the framework of a defined and verified computer code. Ideally, the conceptual model should coincide with the computer model, but

this is not always possible owing to limitations in the computer code. To test the validity of the computer model, it can be calibrated against quantities measured in the field. The goal of a calibration is to minimize the discrepancy between the computer model and measurement results by adjusting the parameters of the model.

When agreement between the computer model and measurement results is good, the model is calibrated against a given set of data. The calibrated computer model can then be used to describe quantities in the system that have not been used in calibration – predictive calculations. These predictive calculations can later be used for new comparisons with measurements.

Validation includes a number of elements, for example a systematic comparison between prediction and outcome and a judgement of whether the agreement is good.

Validation can be performed against different quantities, for example pressure changes, groundwater flow, changes of groundwater chemistry etc. For the long-term safety of the repository, it is valuable to define which types of validations are of the greatest importance. Such judgements can be arrived at through systematic performance and safety assessments. For the Hard Rock Laboratory project, work is currently in progress to systematically determine which statements are to be predicted and validated and which types of measurements etc are to be utilized to validate the statements. This type of work is also going on within the Stripa Project.

#### 6.2.2.4 Some Special Research Areas

##### Fracture Zone Study

In the absence of data to describe groundwater movements in fracture zones, it was assumed in the safety assessment for KBS-3 that a radionuclide that reaches a fracture zone immediately reaches the biosphere. In order to broaden the knowledge base, fracture zone studies have been conducted for several years, among other places at Finnsjön. The intention is to study nuclide retention in fracture zones, investigation methods and the influence of fracture zones on regional groundwater movements.

The first phase of the studies at Finnsjön has previously been reported /6-49/. During 1986-1988, a subhorizontal, approx. 100 m wide fracture zone – Zone 2 – was studied in detail /6-10/ to provide a basis for the tracer tests in the concluding phase.

In the detailed characterization, geology, geohydrology and chemistry have been described. The zone was formed about 1.6 billion years ago and has since been reactivated on a number of occasions. Zone 2 is divided into several subzones, where the uppermost in particular is extremely conductive. A noteworthy fact is that the conductive properties found in all the boreholes that intersect the subzone are persistent and of uniform magnitude. A preliminary tracer test indicated trans-

port over 400 m in a month. A possible interpretation of the high, uniform conductivity is that the zone was activated in connection with the most recent deglaciation.

The groundwater flow was recorded in the zone with a dilution probe. Although large flows were measured, it turned out that the flows further down in the zone were small, despite high conductivity. The supposition that stagnant conditions prevail is supported by the chemical composition of the groundwater, since there is a saline interface in the zone. Although the water is mixed and derives from a number of sources, it is clearly fossil water. The supposition that the salt water is stagnant is also supported by the theoretical calculations for a fresh/saline water interface, which are reported in /6-3/.

The concluding phase of the Finnsjön work involves tracer tests. The project is included in INTRAVAL, where a number of groups have submitted predictive calculations for the tests that have been carried out.

Fracture zone studies have also been initiated at Ävrö /6-50/. The fracture zone is about 120 m thick and dips 40°. The strike of the zone has not yet been conclusively determined. In the same way as at Finnsjön, a more saline water has been encountered in connection with the zone. It has been deemed advisable to carry out most of the Finnsjön tests in order to see whether the technique used provides answers to the relevant questions before the studies on Ävrö continue.

Fracture zone studies have also been conducted in connection with tunnelling work, and the results are being compiled.

##### Subhorizontal Zones

Low-dipping zones are of importance for the layout of a repository and for assessment of performance and safety. Traditional geological investigations provide limited information on the occurrence of subhorizontal zones. It is only through the investigations that have been carried out in Sweden, Finland and Canada that data have begun to emerge on the frequency and properties of horizontal zones.

A subhorizontal zone was encountered on the Kamlung study site at a depth of 550 m. Its conductivity was about 100 times higher than in the surrounding rock. In the same manner, high conductivity zones have been encountered at Gideå, Svartboberget, Finnsjön, Klipperås and SFR. A large number of flat zones were also encountered during the investigations in the nearly 7 000 m deep hole drilled at Gravberg for the deep gas project.

Conductive, subhorizontal zones have also been identified on Hästhölm in southern Finland and in connection with the investigations for URL in Canada.

The low-dipping structures appear often to be highly conductive and to short-circuit the driving forces and flowpaths for groundwater movements that are determined by the topography. This is positive for a final repository, since the water flux around a repository beneath a subhorizontal zone thereby decreases. The properties of the zones are of interest for assessment of

repository performance, since the presence of sub-horizontal zones facilitates the creation of thermal convection cells. For investigation of a site and optimization of the repository, it is urgent that the distance between subhorizontal zones be described, which requires investigations to relatively great depths.

#### Disturbed Zone

The disturbed zone can be defined as “the part of a tunnel or shaft whose physical or chemical properties are altered to such a high degree as a consequence of construction of the repository or of heat generated by the waste that the function of the repository is affected”.

Theoretical calculations show that stress redistribution around a tunnel causes the axial conductivity to increase around the tunnel /6-30/. This must be taken into account when calculating the nuclide transport. Experimental data from Stripa, phase 2 /6-30,6-51/, indicate that the axial conductivity increases by a factor of 1 000 – 10 000 in a zone 0.5 – 1 m around the tunnel periphery.

#### Gas Transport

Studies of gas transport are of importance in cases where a repository contains steel that corrodes anaerobically, producing hydrogen. These effects have been studied within the framework of the safety assessment of SFR and the assessment of the WP-Cave project.

For the analysis of gas transport in SFR, both a discontinuum and a continuum assumption were utilized /6-52,53/.

### **6.2.3 Research Programme 1990–1995**

The research required to attain the goals described in 6.2.1 is best carried out in interdisciplinary projects where geologists, geophysicists, geohydrologists, chemists and other specialists cooperate.

SKB plans to continue to develop conceptual and calculation models in close cooperation with universities, colleges, institutes of technology and other experts.

Over the next few years, most of the planned work will be carried out within the framework of Finnsjön, the Hard Rock Laboratory and Stripa, as described in detail under sections 7.3.3, 9.4, 9.5 and 10.2. The programme for the Hard Rock Laboratory is presented in detail in a separate background report.

#### **Development of Conceptual Models**

Development of conceptual models on different scales is of fundamental importance for increasing our understanding of how groundwater flows in crystalline bedrock. The Hard Rock Laboratory will work in parallel tracks that range from a regional scale down to volumes of a 100 m<sup>3</sup> or so. During the pre-investigation phase, regional groundwater models, discrete network models and simple transport models will be devised.

These models will then be tested and refined during the construction phase. The importance of a tracer test during the construction phase and the operating phase is particularly stressed here. The work at Stripa is, as mentioned previously, focussed on the block scale and on the near field. The “Site Characterization Validation” programme (SCV) will yield material for testing several different types of models. Three different groups are working with modelling of the experiments within the project. In the “Sealing of Fractured Rock” experiment, efforts are being devoted to the “disturbed zone”. The tests at Finnsjön deal with transport on the far-field scale.

A full evaluation of the extent to which tracer test technique is applicable for distinguishing between different conceptual models is required for the further planning of experiments. Such an evaluation is planned both for Stripa and the Finnsjön tests. Based on an integrated evaluation of SCV and the injection grouting tests at Stripa and of the tracer tests, it will be possible to plan which additional experiments can contribute toward an improved analysis of groundwater flow in rock. An evaluation is planned during 1992. This can influence the planning of the tracer tests in the Hard Rock Laboratory. Possible methods are:

- a development of the radar tomography/saltwater methodology. Investigations holes are drilled parallel to a conductive zone,
- a conductive unit of a rock mass is injection-grouted and then dismantled into small pieces. The parts of the rock that have been in contact with the grouting material are then mapped,
- castings are made of typical fracture planes using the technique described in /6-54/ and are then mounted in three-dimensional models.

A question of another character is to what extent the conceptual models are based on a complete body of data. Parameter determinations are based on the data collected in surface investigations, in boreholes and in tunnels. As the field investigations continue, the body of material for description of flowpaths will grow. It would be difficult to prove that the investigations are ever complete. Systematic uncertainty analyses should therefore be carried out concerning what importance overlooked fracture zones, for example, have on the calculation results for flow.

Uncertainty analyses will be carried out in SKB 91. It is hereby essential that calculation models able to take into account random variation in data are utilized and developed, see below.

#### **Development of Calculation Models**

##### Equivalent Porous Medium

High-powered computers will eliminate many limitations on the finite element models, which require so much computer capacity. NAMMU will be used for the calculations when the “equivalent porous medium”

conceptual model is considered applicable. The thermally induced groundwater flow will, for example, be of great importance if the repository is situated underneath a horizontal zone. NAMMU can be used to study effects of this type. Density stratification of saline water and its importance for groundwater flux is another example. A new computation program for sensitivity analysis of groundwater flow, GWHRT-S, was developed during 1989 in an initial version /6-55/. This program will be further developed, including implementation on NAMMU. The program will be applied to study how different input data parameters and boundary conditions affect output data.

### Fracture Network Models

Development of fracture network models is taking place in the Stripa Project. This work will shed light on the usefulness of these models for the safety assessment of a future final repository. The following development is planned of the models NAPSAC and JINX:

In addition to an extensive verification and validation of NAPSAC within the Stripa Project, the calculation

model will permit more general model geometries in the future. The goal is also to couple NAPSAC to a conventional continuum model, NAMMU. This model will calculate the regional impact on the flow field and automatically provide boundary conditions for more detailed local analysis with NAPSAC. Among other planned development, it can be mentioned that a transport model will be included in the program.

The model package JINX is under development at Golder Associates and will continue to be used both within and outside the Stripa Project. Within the project, verification and comparison of the codes of three different model groups will be carried out. JINX will be used in the modelling of groundwater conditions around the future Hard Rock Laboratory. An initial study will shed light on the applicability of the model for actual analyses.

### Application of Models

Table 6-1 shows how conceptual and calculation models will be utilized in ongoing projects.

**Table 6-1. Application and development of models for groundwater flow, 1990–1995.**

PROJECT	MODEL					
	Equivalent porous medium			Stochastic continuum	Fracture work	Channelling
	S	D	T			
<b>HARD ROCK LABORATORY</b>						
– regional scale	+					
– site facility scale		+		+	+	
– block scale	+				+	
– detailed scale	+					
<b>STRIPA</b>						
– regional scale	+					
– site facility scale		+		+	+	
– block scale	+					
– detailed scale	+					
<b>FINNSJÖN</b>						
– site facility scale	+				+	
<b>SKB 91</b>						
– regional scale	+					
– site facility scale	+	+	+	+	+	
– block scale	+			+	+	
– detailed scale	+					
S = saturated flow      D = saturated flow with variable density      T = thermal convection						

## Subhorizontal Zones

The geometry and properties of vertical and subhorizontal zones are of great importance. It is urgent to test better equipment and more refined evaluation methods in order to obtain a description of the frequency and extent of the flat zones at an early phase of the investigations. Targeted geological/geophysical studies have their place in this context. This deeper analysis can take place within the framework of the Hard Rock Laboratory.

The influence of subhorizontal zones on the safety of the repository will be elucidated within the framework of the safety assessment – SKB 91.

## Disturbed Zone

The disturbed zone is being studied within the Stripa Project LSI. Evaluation of this experiment and of the tests being conducted in URL at the 240 m level will serve as a basis for possible supplementary tests in the Hard Rock Laboratory. Such an evaluation should be carried out during 1992.

As far as the impact of the disturbed zone on the safety of the repository is concerned, this can be assessed within the framework of SKB 91.

## 6.3 STABILITY OF THE ROCK

### 6.3.1 Goals of the R&D Activities 1990–1995

The main goals are to:

- quantify or set limits on the effects of earthquakes, ice ages and land uplifts that are of importance for assessing the safety of a final repository for spent nuclear fuel,
- process, evaluate and increase knowledge of the geodynamic processes in the Baltic Shield.

Sub-goals for the period are to:

- supplement and conclude the study of the post-glacial fault at Lansjärv,
- plan and carry out a deeper tectonic analysis in southeastern Sweden,
- conduct a state-of-the-art review of ice ages and study their importance for the long-term safety of the final repository.

### 6.3.2 Present-day State of Knowledge

It is of fundamental importance to understand to what extent tectonic or climatic processes influence the performance of the repository. Low groundwater flux, a favourable chemical environment and the absence of rock movements that could damage the waste are guiding principles for the layout of the repository.

The studies that have been conducted support the notion that plate tectonics, together with the ongoing land uplift, following the most recent ice age, are of crucial importance for interpreting current and future movements in the bedrock. It is also evident that these movements occur preferably or exclusively along major fracture zones of very great age.

As a basis for designing and assessing the performance of the repository, it is also of importance to describe the extent to which a final repository can be affected by future ice ages.

The study of tectonic and climatic factors is wide-ranging and in a state of rapid development. Large national and international projects are underway and are continuously improving our picture of the tectonic processes and effects on the bedrock. General descriptions of these phenomena and their possible impact on the repository are discussed in /6-56,57,58,59/.

The purpose of the following review is not to provide a complete overview of knowledge on the development of the Baltic Shield, but to describe the work that has been done within the framework of SKB's R&D-programme.

#### 6.3.2.1 Tectonic Processes

A general outline of the precambrian evolution of the Baltic Shield is presented in /6-60/. An understanding of this evolution is central to the subdivision of Sweden into tectonic regions /6-61/.

Of importance in this context is to describe the evolution of the Baltic Shield during the past 58 million years, since the time when Scandinavia separated from Greenland and the Mid-Atlantic Ridge was formed /6-63/. Europe and America are currently moving away from each other at a rate of 13 mm per year.

It is this plate-tectonic process which, together with the ongoing land uplift, controls much of the seismic activity in the Baltic Shield. The seismic recordings made during the 1980s /6-63,64,65/ show that the stresses released in earthquakes have a horizontal compression in the direction N60W, perpendicular to the movement in the Mid-Atlantic ridge. The fact that plate tectonics and post-glacial rebound are controlling present-day deformation processes in the Baltic Shield is also shown in /6-66/.

The worldwide database World Stress Map Project shows good agreement between the vector of movement for the plates in the earth's crust and the direction of horizontal rock stresses.

The most probable mechanism for generating a surplus of horizontal stresses in the European portion of the Eurasian plate is a pushing force known as "ridge push" perpendicular to the strike of the Mid-Atlantic ridge. The forces are generated by topographical conditions and the formation of oceanic crust.

If it is assumed on the basis of present-day knowledge that the rock stresses are primarily caused by ongoing plate tectonics, a change in the movement of the

Eurasian plate would be required to generate a new state of stress. Global processes such as plate movements are stable over long periods of time, and it must be regarded as highly improbable that any significant changes will occur within the time spans encompassed by a final repository for nuclear waste.

Of a different nature than plate tectonics is the ongoing process of land uplift. This rapid land uplift is a result of deglaciation, although certain tectonic components cannot be ruled out entirely /6-67/. The remaining land uplift is estimated at 80 to 130 m and will be reached within seven to twelve thousand years. Irregularities in the land uplift rates can be noted. This irregularity, which can be observed both in shoreline displacements and geodetic precision measurements, may have a number of causes. It may, for example, stem from variations in the thickness of the earth's crust.

Of interest in this context is whether horizontal differential movements are taking place in the Baltic Shield. As yet, there is no geodetic data to support this. Measurements in Finland have taken place over too short a period of time to permit conclusions regarding horizontal aseismic creep. Hypotheses concerning aseismic horizontal creep have also been presented on the basis of seismic signal analysis /6-65/, but the validity of this analysis is still under discussion.

If horizontal movements are taking place, it should be possible to measure them by means of long-term geodetic measurements. A prerequisite is that "active" zones can be located. It is possible that such identification could be facilitated by gas sampling of Radon,  $^3\text{He}/^4\text{He}$  ratios /6-68/ or by ESR, electron spin resonance /6-69/, preferably in combination with seismic networks. Morphological analysis carried out within the framework of the Hard Rock Laboratory /6-70/ is also judged to be of value.

In order to describe possible future zones of movement, a thorough tectonic description of a future repository area is necessary.

### 6.3.2.2 Climatic Processes

The factors that control the climate and its long-term variations belong to well-established knowledge. These climatic changes will affect precipitation, erosion, the sea level and thereby the appearance of the biotope.

The forces behind the climatic changes can be attributed to variations in the orbit of the earth and to changes in the composition of the atmosphere.

The Milankovitch cycles can be described in three periodicities: 40 000 years (the tilt of the earth's axis), 22 000 years (precession) and 95 800 years (the eccentricity of the earth's orbit). The effects of these changes can be coupled to glaciations during the Quaternary period, about 1.6 million years.

The evolution of the composition of the future atmosphere is more complex. The connection between rising carbon dioxide levels in the atmosphere and rising average temperature has not yet been fully established.

New glaciations can be expected in the future. This would lead to new states of loading and new boundary conditions for groundwater movements. Of interest is to know whether glaciation is preceded by permafrost and whether altered groundwater chemistry can dissolve existing fracture minerals and thereby increase the water flux through the repository. Another factor to take into consideration is whether significantly increased gradients can lead to a high water flux through the repository. Water pressure conditions during deglaciation can in some cases be important for the sizing of eg a canister.

The Lansjärv study has shown that movements have taken place in conjunction with the most recent deglaciation, see section 6.3.2.4 below. This movement is judged to have taken place in connection with a strong increase in seismic activity. The supposition that seismic activity increases at the margin of a glacier is also supported by measurements in the Arctic and Antarctica /6-71/, which is especially true when the horizontal forces are greater than the vertical ones.

In the Swedish debate it has been asserted /6-72/ that there are areas "full of faults and fractures, created during, and in particular just after, the retreat of the ice from the region approximately 10 000 years ago".

The contention that movements occur in the bedrock in connection with a deglaciation is established knowledge and is also supported by calculations /6-17/. What is of interest, however, is to see whether these movements reactivate old fracture zones or whether new fractures are formed, see further section 6.3.2.4.

A sequel question is how the repository should be designed to avoid zones of movement. Model studies and variation analyses can also shed light on the importance of new fractures. Analyses performed to date show that the effects are limited /6-73/.

### 6.3.2.3 The Impact of the Repository on Mechanical Stability

The construction of a final repository leads to local changes in the rock. Factors to consider in the analysis are eg:

- can repository construction act as a "large-scaled (fracture) flow" for future movements?
- does heat emanation from the fuel cause permanent mechanical changes?

As regards temperature effects, these have been dealt with for the KBS-3 alternative /6-74/. The study included analysis of mechanical action and of convection.

The extent to which the heat emanated from the repository gives rise to mechanical movements in the vicinity of the canisters should be further studied. Such an evaluation is being done with the near-field model developed to study the interaction between canister and rock, see Section 5.3.3.3. Further information is required in relation to the KBS-3 study to make sure that

the thermal load does not give rise to large-scale movements at the borders of the repository, causing (sub-horizontal) flowpaths to be opened from the repository to surrounding zones. Such an analysis is planned.

A number of different finite element models have been used by SKB to calculate thermomechanical stresses in the rock. These continuum models include ABAQUS, ADINA and HNFEMP. Discontinuities such as fractures and faults are distributed over the entire rock mass in these models. An alternative method is UDEC, where the rock is regarded as a discontinuum, see further Section 6.3.2.6. Preliminary models for temperature load in UDEC exist.

#### 6.3.2.4 Post-glacial Movements

In 1986, extensive research was begun on the presumed post-glacial faults in the Lansjärv area. Lansjärv is located approximately 150 km north of Luleå. The goals of the studies at Lansjärv were to:

- assess the mechanisms that have caused present-day scarps,
- clarify the extent of any recent fracturing,
- clarify the extent of any ongoing movements.

The investigation was begun with a tectonic analysis of an approx. 150 x 200 km large area around Lansjärv (see Figure 6-4) based on geophysical survey results.

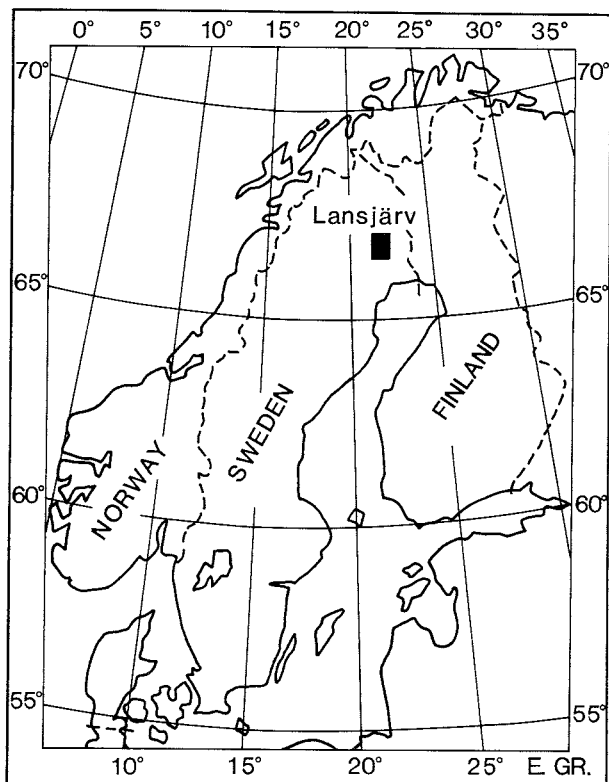

Figure 6-4. The Lansjärv area.

Through this analysis, three regional fault systems were located - two steeply dipping, one with a north-westerly and the other with a northerly strike, and a third weakly dipping towards ESE with a strike towards NNE. The post-glacial faults in the area are included in this fault pattern and are deemed mainly to have reactivated older low-dipping zones /6-4/. Structural-geology field studies have mainly aimed at examining the kinematics and recent dynamics of the geological deformation structures as they appear in the exposed bedrock in and near presumed post-glacial faults - PGF, (Lansjärv and Pärvie) and in connection with the geophysically indicated lineaments that strike toward N and NW. Kinematic arguments suggest that the NNE- and NE-erly striking shear zones, which were reactivated in connection with the formation of the post-glacial faults, are only the most obvious signs of a more general post-glacial reactivation process /6-75/.

#### Quaternary Geology

Through excavations straight across the approx. 20 m high and 50 km long NNE-erly oriented post-glacial fault scarps in the Lansjärv area, it has been possible to date the fault movements relative to the quaternary stratigraphy /6-76/. The post-glacial faults were formed in a context shortly after the retreat of the ice sheets approximately 9 000 years ago, and the faults can be associated with earthquakes with a magnitude of  $M_L$  6.5–7.0 or greater, judging from the dimensions of the faults and landslides within the region. Furthermore, the faults are judged to be reverse and to dip 40–50° or steeper.

#### Seismic Networks

During the period 1987–1989, a permanent seismic network – under the auspices of FOA (the Swedish Defence Research Institute) – recorded more than 90 earthquakes, with signals from three or more stations, in the northern part of Norrbotten County. The magnitude of the quakes lies between  $M_L$  0.1 and 3.6, and the focal depth between 5–15 km. The dominant fault mechanism appears to be strike-slip movements, but normal and reverse fault movements are also common. The two largest recorded quakes are interpreted as reverse faults. This supports the notion that the present-day tectonic activity is similar in character to the activity that built up the reverse stresses that were released in connection with the deglaciation in the Lansjärv area /6-65/. The results also suggest that it is the horizontal plate movements – and not land uplift – that is the primary cause of the seismic activity in northern Sweden. During the summers of 1987 and 1988, a mobile seismic network – operated by the Seismological Division in Uppsala and consisting of six stations – was deployed in the Lansjärv area. This network is able to record weak superficial quakes and has an accuracy for epicentre determination estimated to be within  $\pm 100$

m. It therefore constitutes a good complement to the permanent network of stations. More than 20 earthquakes were recorded with the mobile network within a distance of 40 km from the measuring stations during 1987. Nine of these were pinpointed more precisely, and focal depths of 8 and 9 km were calculated for two quakes. Several of the quakes were located east of the post-glacial faults. Approximately 30 quakes were recorded in the Lansjärv area during the summer of 1988. Eighteen of the quakes were pinpointed more precisely, and there are calculations for six of these that indicate a focal depth of between 5 and 12 km. There is no clear correlation between the quakes and the post-glacial structures. Some quakes can be related to an older fault that strikes at almost a right angle to the principal post-glacial direction. Of all the quakes recorded during the two years, the magnitudes in a few cases amount to a maximum of  $M_L$  2.4 /6-77/. Most quakes have a much lower magnitude.

### Borehole Investigations

On the basis of tectonic and geophysical measurement results, a number of boreholes were drilled – about 5 km north of Lansjärv – within a kilometre or so of a post-glacial fault (PGF) located by excavation. The purpose of the drilling was mainly to investigate whether the rock mass immediately adjacent to a presumed PGF differs with regard to rock stresses, hydrogeology, chemistry and fracture minerals from bedrock in other parts of Sweden. According to the geological tectonic model, three fracture zones low-dipping towards the east ought to have been drilled through within a depth of 100–200 m from the ground surface. A nearly vertical cored hole exhibited a very high fracture frequency in its upper portion, down to about 250 m. Below this level, the fracture frequency was normal for the granitic rock types that dominate in the borehole. Some presence of amphibolite, mylonite and pegmatite was also noted. Within the section 110–265 m in particular, there were several crushed and sometimes clay-altered zones. Due to a collapse at a depth of 148 m, the borehole had to be lined with casing down to a depth of 152 m. For the purpose of locating these zones, two percussive boreholes were collared approx. 400 m west of the cored hole in the direction towards the excavated post-glacial zone. In both of these boreholes, the drill rod got stuck in crushed zones at a depth of about 90 m.

The groundwater in the cored hole has been sampled and analyzed at depths of 150 and 237 m. The composition of the water from the two levels was largely identical, with a low concentration of solutes, which agrees with experience from other parts of the basement rock in Norrbotten County, for example Kamlunge.

Rock stress measurements by means of hydraulic fracturing were carried out in the cored hole at 27 different levels. Twenty measurements at the 300–500 m level yielded useful results. The results showed extreme-

ly low values for the minimum horizontal stress compared with measurements from other parts of Sweden. The maximum horizontal stress rotates from NW-SE to ENE-WSW within a depth interval of about 200 m.

Mineralogical and geochemical studies of fracture minerals from the drill core have been carried out in a project in collaboration with SKI. The sampling of the core was concentrated to the crushed zones within the section about 140–150 m and a number of fracture zones, which were assumed to be water-bearing. The samples were examined by means of INA and X-ray diffraction analysis as well as by microscoping of thin sections. The results indicate extensive hydrothermal activity, probably combined with circulation of hydrothermal solutions. This has caused formation of haematite, quartz, epidote, zeolites and, in a final phase, calcite followed by Fe-oxyhydroxides. Subsequent circulation of low-temperature groundwater has led to redistribution of elements and minerals, such as dissolution of calcite and release of U and light rare-earth metals in the upper part of the borehole, followed by sorption of these elements on Fe-oxyhydroxide phases at greater depth. In summary, it can be said that there are signs of extensive hydrothermal alteration under oxidizing conditions in connection with intensive fracturing, especially in the upper 300 m of the drill core.

The geohydrological investigations have included water injection tests in the cored hole, observations of groundwater pressure levels in cored holes and compilation of a map of the groundwater levels within the area. Numerical modelling has also been carried out to investigate to what extent measured hydrological data can be explained by the current geological interpretation for the area. The hydraulic conductivity in the cored hole is greatest – more than  $10^{-6}$  m/s – in the upper approx. 200 m deep part of the borehole, where the fracture frequency is great. Below this level, the conductivity is mostly lower than  $10^{-8}$  m/s, except in a few 3-metre sections that coincide with small fracture-crushed zones. There is, however, no clear-cut correlation between hydraulic conductivity and fracture frequency (rock type). A comparison between the cored hole at Lansjärv (below 200 m deep) and a large number of boreholes previously drilled in connection with the KBS-3 investigations reveals fairly similar conditions from a conductivity viewpoint. Numerical groundwater modelling of a general nature has been carried out in order to shed light on what importance the orientation of fracture zones has for groundwater conditions. At Lansjärv, it is the low groundwater pressures in the boreholes that need to be explained. The calculation results show that a steep post-glacial fracture zone can easily explain the obtained hydraulic measurements, while a subhorizontal fracture zone, according to the interpretation model on which the setting-out of the boreholes was based, gives poorer agreement. Alternatively, there are additional subhorizontal zones at great depth.



## Geophysics and Tectonics

The research group, which will publish the results of the different sub-objects in a joint final report /6-17/ during 1989, has compiled the following general conclusions:

### General Conclusions

1. Since the majority of the fractures that can be observed in the excavated profiles across presumed PGFs are highly chemically altered, it can be assumed that they are of pre-Quaternary age. Similar observations can be made in the upper, approx. 300-metre-long part of the drill core. Furthermore, large portions of the post-glacial faults coincide with magnetically indicated oxidation zones. An indication of a possible new formation of fractures in connection with post-glacial movements has only been observed on one excavated rock surface immediately adjacent to a PGF. The post-glacial movements at Lansjärv are therefore considered to have been released primarily through reactivation of already existing fractures and faults.
2. The pattern and kinematics of the post-glacial faults do not have the radial or tangential extent to be expected as a result of post-glacial uplift. The extent of the faults is more commensurate with the effects of plate-tectonic movements.
3. The post-glacial structures in northern Fennoscandia are prominent tectonic features that were formed in recent time in a bedrock characterized by a relatively large number of regional shear zones with an NW-SE and N-S orientation. The relief in the area is generally low and the present-day rate of land uplift is relatively high.
4. The orientation of older zones of weakness in northern Fennoscandia favours the occurrence of PGFs in the form of thrust faults and reverse faults.
5. The reactivation of PGFs in Lansjärv has taken place through tectonic movements, which may have been released in connection to the deglaciation.
6. The hydraulic conductivity in the cored hole at Lansjärv does not deviate significantly from the conditions measured in a large number of other boreholes in Swedish basement rock.
7. It is deemed that zones of movement of the thickness studied can be avoided by the proper layout of the repository. Even if zones are not located in surface and borehole investigations, they can later be located in connection with detailed investigations and repository construction. Despite the very dramatic formation of the PGFs at Lansjärv, neither hydraulic conductivity nor groundwater chemistry at typical repository levels is remarkable in any way. It has, however, not been possible to specifically distinguish the effects of the last ice age for depths greater than 300 m, since the conditions measured are the result of accumulated disturbances that

have taken place in the rock over many hundreds of millions of years and a number of glaciations.

### **6.3.2.5 Modelling of the Rock Mass**

The mechanical properties of the rock mass – strength and deformations – can in principle be simulated by continuous or discontinuous models.

In discontinuous models of the mechanical properties of the rock mass, discontinuities with known or assumed parameters are introduced into the models and the intervening blocks are treated as completely rigid or elastic materials. The distinct element method is one of the methods used to determine whether the rock mass will fail under a given applied load or to calculate the displacements that have accumulated when the system finally reaches a stable state. As a basis for modelling of ice ages, two computer programs have been tested against physical model experiments.

At the Colorado School of Mines' experimental mine in Idaho Springs, a block of granitic gneiss sized 2 x 2 x 2 m, the CSM block, was tested. The block was subjected uniaxially and biaxially to a load of more than 5 MPa by means of hydraulic flat-jacks. Displacements between fixed points on the surface, inside the block and across the entire block, as well as rock stresses, were recorded for different loading cases. The extensive primary results from the block tests were compiled and evaluated to be used in the work of testing the programs HNFEMP and MUDEC. HNFEMP is a finite element method in which the rock is described as a continuum. MUDEC is a finite difference code that describes the rock as a discontinuum.

#### HNFEMP

The magnitude and direction of the calculated deformations between different points in the block, as well as for the entire rock mass in the block, show very good agreement with measured displacements in the block tests for the most probable fracture rigidities.

Modelling with continuous models yields stresses in the block that are in direct proportion to applied loads. The direction of the principal stresses and the average measured stresses in the block have been simulated in a satisfactory manner in the modelling work. /6-78/

#### MUDEC

In testing of the distinct element method MUDEC against the CSM block, it has been assumed that the block consists of four smaller blocks surrounded by discrete fractures – a simplification /6-79/.

When the loads are applied to the block, the individual rock blocks move and rotate. The deformations will thereby vary from point to point in the system, but on the whole directions and magnitudes are obtained that fall within measured values for the CSM block. Par-

ticularly good agreement has been obtained with regard to the shear deformations.

### Modelling of Ice Age

After testing, the codes HNFEMP and MUDEC were applied to studies of the mechanical response of large rock masses to glaciation, the fluid movement of the ice sheet and deglaciation. A two-dimensional section of a 4 x 4 km portion of a rock mass containing one or two fault groups was loaded with rock stresses of a magnitude that can be expected to prevail in the Fennoscandian bedrock.

The modelling is of an introductory character /6-17/. Difficulties exist in making correct estimates of the mechanical properties of the faults. Furthermore, all fractures are continuous, which means that the models work like a stack of bricks.

In cases where the same input parameters have been used for faults and for intact rock, good agreement has been achieved between the results of the two modelling codes.

During a loading cycle, the rock mass is subjected to considerable load changes, which in turn result in permanent deformations. The top surface of the 4 km deep rock mass in the model is pressed down about 4 m as a result of the ice load. In the models, the bottom is locked against movement in the vertical direction, while in actuality the earth's crust rests on a plastic upper mantle. In the case with two intersecting fault groups with distances of 200 and 500 m between the faults, respectively, a differential shear deformation takes place between the blocks on the order of 4–5 cm in the case with rigid faults and linear MUDEC modelling. Deformations of this order of magnitude also apply approximately 500 m below the ground surface, and these can be expected with great probability to alter the hydraulic properties of the rock mass.

The load of 3 km of ice on the top surface of the model entails an increase of the vertical stress by about 25 MPa at a depth of 500 m. After the retreat of the ice sheet, the stresses return with small deviations to the initial state, ie the state determined by prevailing rock stresses. The additional stress resulting from the ice load must be superimposed on the rock stresses in the design work for a final repository.

### **6.3.2.6 Experience of Earthquakes**

R&D-Programme 86 described plans for compiling existing documentation on how underground facilities, mines and wells are affected by seismic events. A collaboration was initiated with US/DOE. Due to a change in the premises for the American waste programme, the planned bilateral study has been given another direction. SKB is now in direct contact with the principal consultants, who are in charge of the tectonic description of Yucca Mountain.

SKB is also conducting a project aimed at compiling seismic events where underground facilities, mines and boreholes have been affected. Geohydrological, geochemical and mechanical changes are of particular interest /6-80/. As far as mechanical impact is concerned, no damages have been reported for quakes that produce ground accelerations below 0.2 g. SKB also reviewed Japanese records on a study trip to Japan. Evaluation of these results is included in /6-80/. It was found, as expected, that the intensity of earthquakes is considerably lower underground than on the surface.

There is no record of tunnels collapsing completely due to earthquakes. Minor damage has been reported in cases where a fault intersects the tunnel and very strong earthquakes occur within a kilometer or so of the tunnel.

Few observations and published data exist on changes in geohydrological conditions, but inflow into underground facilities has been reported to increase by 40–300% for some events.

### **6.3.2.7 Studies in Southeastern Sweden**

The southeastern part of Sweden – with a bedrock dominated by approx. 1700–1800 million year old Småland granites with associated volcanites – appears to be the most stable part of Sweden. This conclusion is based on the fact that the precambrian peneplain only shows signs of local minor displacements, both where it is covered by Cambro-Silurian sediments and where the precambrian relief is preserved. It can further be concluded from existing records that seismic activity is extremely limited. Southeastern Sweden thus appears to constitute a delimited area bounded on the west by a major tectonic zone of regional extent – the Protogine zone.

#### The Protogine Zone

The Protogine zone extends from Skåne northward to Lake Vättern and in through Dalsland. Different faults branch out from the main zone towards NNE, for example through the Almesåkra area and Lake Vänern. SKB is investigating the traces of different fault movements along the Protogine zone. Displacements that have taken place in the past 1000 million years (Ma) or more can be detected. More recent, brittle structures in the old crystalline bedrock are more difficult to date, but some structures surround the Vättern Depression (about 850–650 Ma) and constitute evidence of active faults. Some of the faults intersect the most recent rock types in the Visingsö formation and can be related to the fracture zones that cause displacements in the Cambro-Silurian rock types in Östergötland. Faults have been demonstrated in Cambrian strata in the vicinity of Omberg. Other faults are Permian or more recent (290 Ma), which is demonstrated by disturbances of the diabases in the Västgöta Mountains. Even though the Protogine zone appears to have had little ef-

fect on the more recent sedimentary layers in Skåne, it has clearly been active much more recently. A large part of the seismic activity that has been recorded historically has been concentrated at the western edge of the zone. There are local signs of displacements in Quaternary sediments.

#### Seismic Networks

During the period 1986–1988, SKB financed a seismic network with four stations in southeastern Sweden. The network was installed and operated by FOA (the Swedish Defence Research Institute). The reported analysis of recorded quakes has also included data from a number of other stations operated by FOA in western and central Sweden /6-64/. During the third quarter of 1988, the last for which the network was in operation, the first quake was recorded within the seismically silent east coast of Småland. It was a magnitude  $M_L = 1.0$  quake that occurred at a depth of 16–17 km approx. 20 km south of Oskarshamn. The analysis of the quake showed a relatively high static stress drop in view of the small size of the quake. The displacement in the quake fault was estimated to be about 1 mm. The most probable quake mechanism is strike-slip with the horizontal compression direction NW-SE. The two possible fault planes have strikes of N-S or E-W, the planes are nearly vertical.

#### Geological-tectonic Studies in the Simpevarp Area

In connection with the pre-investigations for the Hard Rock Laboratory in the Simpevarp region, geological-tectonic analysis has been carried out both on a regional and a local scale within a large area between Oskarshamn and Västervik /6-2/. The tectonic analysis has been based on a large number of airborne geophysical surveys, satellite pictures and lineament studies as well as petrographic and structural-geological field mapping. Airborne magnetic aerial surveys, in combination with gravimetric ground surveys, indicate a number of circular or semicircular structures that are interpreted as diapirs of younger (anorogenic) granites in the large mass of Småland granites of different varieties that constitute the main rock type in the Simpevarp area. The circular structures – especially the Götemar massif – are also clearly visible on satellite pictures. Lineament studies of relief maps and structural analysis of different digital models have – together with data from the airborne geophysical surveys, magnetic and electrical – provided a good picture of the superregional tectonic pattern. This is especially true of the steep major fracture zones which, according to this interpretation, occur in two nearly orthogonal systems – N-S, E-W on the one hand and NW-SE, NE-SW on the other. Attempts to locate possible subhorizontal zones detected within the overall region by Nordenskjöld /6-81/ and more locally by Gustafson et al /6-3/ have mainly been done by means of seismic reflection surveys. Lineament studies on a more local scale show that the regional tectonic patterns

mentioned above are repeated in the local pattern. This is further confirmed by other investigations in the area /6-3/. Fracture zones that strike N-S and NE-SW are said to be the most probable water-bearing zones. The subhorizontal zones should also be taken into account in this context. According to /6-3/, the oldest structures in the Simpevarp area coincide with the regional pattern of the Småland-Värmland batholith. The basic dykes and the diorite-gabbro rocks encountered in the boreholes on Äspö were formed by continuous “magma mingling and magma mixing processes”. The intrusion of the anorogenic granites has had little tectonic effect on older surrounding bedrock.

### **6.3.3 Research Programme 1990–1995**

#### **6.3.3.1 State-of-the-art Knowledge Review of Ice Ages and Land Uplift**

In its research program R&D-Programme 86, SKB stated that a deeper analysis of ice ages and land uplift may be warranted. This recommendation was supported by a number of reviewing bodies, both national and international.

In order to compile knowledge and evaluate what importance ice ages and land uplift may have for the assessment of the safety of the repository, TVO and SKB have decided to carry out parts of this assessment jointly. Furthermore, a more general joint Nordic study has been proposed.

The goals of TVO's and SKB's review are to:

- describe conditions before an ice age and how the ice sheet grows,
- describe conditions under the ice (groundwater movements and groundwater chemistry) and under the pressure of the earth's crust,
- describe the retreat of the ice sheet,
- describe land uplift.

Of particular interest is to shed light on whether an ice age is preceded by permafrost at great depth, whether groundwater chemistry is dramatically altered under a glacier, whether easily soluble fracture minerals can be dissolved and lead to higher groundwater flux at the repository level, whether deglaciation leads to low effective stresses at great depth in the rock and large movements in the bedrock.

The work is being done in stages. It is estimated that most of the work will be concluded by 1992. The evaluation can lead to specific proposals for supplementary data collection.

#### **6.3.3.2 Deepened Tectonic Analysis**

In the review reports on R&D-Programme 86, a number of reviewing bodies mention the importance of tectonic analysis. The planned measures around Lansjärv

reported above were judged to be exemplary, but some reviewing bodies were doubtful whether it would be possible from these studies to devise an investigation methodology to identify newer tectonic phenomena even within other areas that do not exhibit as clear traces as in Lansjärv. Several reviewing bodies also pointed out the importance of understanding the large-scale structures in a regional context.

SKB also deems it suitable to carry out a deeper tectonic analysis in the regional area surrounding the planned underground Hard Rock Laboratory at Äspö. Thanks to the earlier regional and local investigations /6-2,3/, high-quality data is available for this analysis.

In the same way as for the Lansjärv investigations, it is important to describe the presence of possible recent fracturings, to describe ongoing processes in the area, to clarify the presence of ongoing movements and to locate potential zones of movement.

Valuable contributions to regional understanding can already be obtained from /6-82/. It is foreseen that Äspö will be mapped with respect to possible post-glacial fractures using a methodology described by Mörner /6-72/.

The tectonic analysis around the Simpevarp area carried out on the basis of digital elevation data /6-70/ can be the point of departure for deploying a geodetic network for long-term monitoring of movements. Data from Finnish and Swedish geodetic measurements of horizontal creep movements in the Baltic Shield will be compiled. Such a network should be supplemented with gas analysis over a profile /6-68/.

Seismic signals are of value for a tectonic interpretation. It is foreseen that such data can be obtained from a Swedish seismic network, see further Section 6.3.3.4.

It is deemed very valuable to support the tectonic understanding with numerical modelling in a manner similar to that described above in Section 6.3.2.6, where effects of glaciations are also included.

In view of the fact that the Lansjärv project has not yet been fully concluded, it has been deemed proper to plan the measures for the deeper tectonic analysis during 1990 so that a collected and goal-oriented project can be initiated in 1991. In such a project, it is also appropriate to formulate guidelines on how the layout of the repository is to be determined with a view toward possible future movements.

### **6.3.3.3 Conclusion of the Lansjärv Project**

A full account of the Lansjärv project has been completed. It has not been possible to resolve all questions to full satisfaction during the course of the project.

SKB therefore plans supplementary work during 1990. A new trench is planned with a longer extent in order to observe indications of new fracturing adjacent to the zone, short boreholes will be drilled in the zone's hanging wall in order to determine the dip, and a relatively short cored hole will be drilled to investigate whether the hydrothermal transformation is typical for the area.

The work at Lansjärv will also be reported at an international seminar.

### **6.3.3.4 Operation and Analysis of Seismic Data**

SKB expects that an agency will be appointed to take charge of the operation of an efficient seismic network. SKB will periodically support the analysis of the recorded data.

If no Swedish network is established, it is foreseen that SKB will establish a network around the site of the final repository. Such a network will not become operational for at least ten years, however.

### **6.3.3.5 International Projects**

A large number of very large international projects are currently underway in the geoscientific field, for example the International Lithosphere Project, ILP.

The documentation is extensive and is growing rapidly. The knowledge that is emerging is relevant for an understanding of the ongoing geodynamic processes in the Baltic Shield, and for a greater understanding of ice ages and of sea level variations in historic time.

SKB is planning to appoint an observer to report regularly on specific knowledge within international projects that is of use for SKB's geoscientific programme. This should include reporting interesting new quakes, for example the large earthquakes of magnitude  $M_s$ , 6.3, 6.4, 6.7 that have occurred in a region of low seismicity /6-83/.

SKB has collected certain data on the effects of earthquakes etc on underground facilities in Japan. This material will be included in the current compilation /6-80/. It is foreseen that compilations of this type will continue to take place in international collaboration.

SKB will also participate in ISRM's (International Society of Rock Mechanics) Commission on Tectonic Stability and Site Selection.

## 7 CHEMISTRY

### 7.1 GROUNDWATER CHEMISTRY AND GEOCHEMISTRY

#### 7.1.1 Goals of the R&D Activities

The geochemical investigations have the following purposes:

- to gather sufficient knowledge concerning the chemical properties of the groundwater and minerals that determine canister dissolution, buffer stability, fuel dissolution and radionuclide migration,
- to determine what chemical changes in the natural environment could be caused by the repository or inflowing water of a different composition,
- to verify the geohydrological model for water flow in a repository area.

#### 7.1.2 Present-day State of Knowledge

##### GROUNDWATER TYPES

At great depths in the bedrock (> 100 m), two different main types of water occur: fresh and saline. These waters either have completely different origins or completely different residence times in the bedrock. It is, however, difficult to determine a priori whether residence time or origin is crucial. In many cases, it is possible that the saline waters not only have a different origin than the fresh waters, but also a very long residence time.

##### Fresh Water

The fresh groundwater has its origin in rain and snow that, in the form of surface water, penetrates down into the rock. When the water passes through the soil layer, it absorbs carbon dioxide produced by the biological processes that take place in this layer. The water then becomes acidic and aggressive. Much of the subsequent composition of the groundwater is determined by how much carbon dioxide is absorbed when the water passes through the soil layer /7-1/.

When the acidic water has come down to the bedrock, a chemical weathering process begins that continuously alters the composition of the groundwater. The carbon-dioxide-rich water first attacks the highly soluble calcium-containing minerals present in the fracture systems /7-2/. Through the dissolution of calcite, the water's content of calcium and carbonate increases at

the same time as its pH approaches neutral values. The result is a water that consists for the most part of calcium and carbonate with some magnesium and iron. The variations in concentrations that occur are probably caused by variations in the carbon dioxide content /7-2,3/.

At longer residence times, an exchange takes place between calcium and sodium. At the same time as the dissolution of the less soluble sodium minerals increases, the pH increases. As a result, some of the calcite that was previously dissolved will precipitate again. Often a simultaneous dissolution of calcium from other calcium-rich minerals takes place, so that the calcium content remains constant while the carbonate content declines. These fresh deep groundwaters contain similar contents of sodium and calcium and contain, in addition to carbonate, also some chloride and sulphate as well as low levels of other anions and cations. Their pH is around 8.

At longer residence times, the pH and the chloride content eventually increase, while the carbonate content decreases. A continuation of the process in this direction results in saline water /7-2/.

##### Saline Water

The saline water has two possible origins. Either it is a marine water that has penetrated down into the rock on some occasion, or it is originally a fresh water that has become saline during a very long residence time in the rock through various processes. Water of metamorphic origin has not yet been encountered.

During the period since the most recent ice age, the Baltic Sea has passed through various phases from the Baltic Ice Lake to the Yoldia Sea in 8000 B.C., Ancylus Lake in 7000 B.C., the Littorina Sea in 5000 B.C., which later developed into the present-day Baltic Sea. Both the Yoldia Sea and the Littorina Sea contained brackish water. The salinity of the Littorina Sea is considered to have been at its highest about 3 times higher than in the Baltic Sea, while the Yoldia Sea had a lower salinity /7-4/. It can be presumed that the ion proportions were the same in all cases. Groundwater with a salinity higher than that of the Baltic Sea may thus derive from the Littorina Sea or may have its origin in times before the retreat of the most recent continental ice sheet.

At places that lie below the line to which the sea reached after the most recent ice age, it can be assumed that saline waters are of marine origin. At other locations, the saline waters derive from water-mineral reactions or sea water from the time previous to the most recent glaciation. Processes that have contributed to the water's becoming saline may, besides being purely

chemical, also be physical, such as when a permafrost has slowly frozen salt out of the water.

## CONCLUSIONS BASED ON THE VARIATIONS OF FRESH AND SALINE WATER

Sharp boundaries rarely exist between saline and fresh water. The changes do, however, often occur in increments as a function of depth. The size of these increments is dependent on the site-specific conditions. Table 7-1 illustrates the characteristic parameters of the salt waters that have been encountered.

Table 7-1. The composition of saline waters tested in connection with SKB's investigations. All contents are given in mg/l, except pH. Depth is in metres.

Site	Depth	Na	K	Ca	Mg	Cl	SO <sub>4</sub>	HCO <sub>3</sub>	pH
Äspö	860	3100	6	4300	70	12500	710	10	8.2
Finnsjön	439	1700	13	1600	120	5500	380	48	7.0
SFR	100	1500	20	1100	250	5000	490	90	7.5
Stripa	870	290	3	170	1	700	100	13	9.3
Fjällveden	625	300	1	40	1	470	1	16	9.0
Gideå	596	150	2	60	1	300	1	70	8.9

### Äspö

Äspö is the site where, among those investigated so far, the most clear-cut picture of groundwater chemistry has been obtained /7-5/. Because it is surrounded by bays of the sea on all sides, there are very small pressure gradients to bring about a water flux in the bedrock. The water on Äspö is therefore saline already at relatively shallow depths. There is, for example, a borehole that goes down to a depth of 100 m, but nevertheless contains water with a chloride content of 5000 mg/l, which is about 50% higher than the Baltic Sea.

At greater depths, about 800 m, the salinity is higher than it is assumed to have been in the Littorina Sea. It is therefore probable that this water has resided in the rock for a very long period of time. Datings of less saline waters point towards tens of thousands of years /7-6/.

### SFR and Finnsjön

Salt water has been found at both SFR and Finnsjön, in SFR only salt water, while the water at Finnsjön is both salt and fresh. At both places, the salt water is of similar character, see Table 7-1. The salinity is approximately twice that of the Baltic Sea.

At Finnsjön, the boundary between salt and fresh water coincides with a subhorizontal zone, see Section 6.2.2.4. This is scarcely a coincidence, but is explained by the fact that this conductive unit drains fresh water away due to the pressure gradients that are applied from above. It is also possible that the mixing between fresh and salt water in the zone results in calcite precipitation and sealing of the fractures.

Both in SFR and at Finnsjön, the water composition indicates that the origin of the water may be the Littorina Sea. However, it is impossible to exclude the possibility that the water is even older and is a mix between very old water, Littorina water and fresh water.

### Stripa

Both salt and fresh water occur at Stripa. The salt water has a salinity that is only one-tenth of that of the water at Finnsjön and SFR. Stripa lies above the highest shoreline. It therefore appears reasonable to assume that this water has not been affected by sea water or by the most recent deglaciation. Its composition is different from that of the waters at SFR, Finnsjön and Äspö. In particular, the saline Stripa waters have a very high pH, above 9 /7-2/.

Owing to the fact that the Stripa mine has been drained over such a long period of time, it is unlikely that the boundary between fresh and salt water is determined by anything other than the pressure conditions that prevail as a consequence of the drainage. It is also probable that the forced water flow has led to a mixing of fresh and salt water that would otherwise not have occurred /7-7/.

### Other Sites

Only fresh groundwater has been found on most study sites. This may be because the study sites have been pronounced inflow areas.

One sampled section at Fjällveden and one at Gideå have yielded water samples containing high salinities. These waters bear certain similarities to the Stripa water. At the same time, certain differences in composition are also found. The explanation for this may be that the geology at Stripa differs from the geology on the other sites.

## SPECIAL PROPERTIES OF THE GROUNDWATER

Except for the difference between fresh and salt, the character of the groundwater is very stable. The groundwater's chemical properties reflect those of the rock. The differences between waters on different sites are therefore small. It is probable that those variations that exist are primarily due to the fact that the hydrological conditions vary.

### Redox Conditions

All deep groundwater in SKB's investigation bank is reducing. Most of the dissolved oxygen present in the water is consumed by the biological processes when the water penetrates down through the soil layer or the bottom sediments. It can be assumed that the remaining oxygen residues are reduced by the iron-containing minerals in the uppermost parts of the rock. Oxidized

fracture faces in the uppermost part of the rock indicate that this is the case /7-8/.

The carbon-dioxide-rich water that causes calcite dissolution also raises the concentration of iron in the water. Within the depth interval 0–100 m, water with iron contents on the order of 1–10 mg/l has often been sampled. This is probably a consequence of carbon dioxide weathering of biotite and other silicate minerals containing iron. Since pH and sulphide content increase with depth, iron content decreases. Iron sulphide is in equilibrium with the groundwater /7-9/.

Measured redox potentials are tightly grouped within a narrow interval. The magnetite-hematite equilibrium and the ratio between bivalent and trivalent iron in silicate mineral describe very well the Eh-pH relation in the measurements. An empirical relationship between pH and Eh is

$$Eh = (200 - 60 \times \text{pH}) \text{ mV}$$

The redox capacity of the water is low. The rock, on the other hand, has a very high redox capacity in the form of 1–10% iron, most of which is present in the bivalent form. But it is difficult to judge how large a fraction of this quantity is available for reactions with oxidants.

### Exchange Time

The groundwater does not have any clear-cut exchange time in the bedrock. It is, however, possible to speak of a relative “mean exchange time” where the different waters can be gradated relative to each other via composition and contents of radioactive isotopes. The most important parameters and their implications can briefly be described as follows:

- Salt water with a chloride content in excess of that of the Baltic Sea may originate from the Littorina Sea. This means that it has resided in the bedrock for about 7000 years. In cases where the salt derives from reactions between the bedrock and the groundwater, its age is much higher, probably up to millions of years in brines. Salinity can be taken as a measure of relative age.
- Carbon-14 datings give the water’s theoretical age. The half-life of carbon-14 is 5568 years, which covers the period of time of greatest interest, about 1000–30000 years. There are, however, a number of processes that lead to overestimation of the age of the carbonate content in the groundwater. In short, these processes involve an interaction of the carbonate in the water with carbonate in the bedrock. By combining carbon-14 datings of both inorganic and organic carbon in the water, it is possible to obtain a clearer picture of the age distribution.
- Tritium has a half-life of 12.26 years. Measurable tritium contents thus indicate the presence of very young water.

- Oxygen-18 and deuterium show together whether the water is of meteoric origin. The oxygen-18 contents reflect the climatic conditions that prevailed when the water was infiltrated and can thus provide some idea of when this happened.

By weighing in all these “age data”, it is possible to get an idea of the age distribution in the water being analyzed. The combination of tritium and carbon-14 is often useful for showing whether the water that has been sampled is representative. Disturbances caused by drilling and by the borehole can often result in a combination of high carbon-14 ages together with measurable tritium contents. There are, however, other reasons why water has both tritium and a high carbon-14 age. A combined analysis of all data from several sampling points in the same area is necessary to ascertain the exchange time.

### Fracture Minerals and Mineral Equilibria

Analysis of the groundwater provides a clear picture of the chemical situation at the present time. By analyzing the chemical properties of fracture-filling minerals, it is possible to get an idea of the stability in the picture presented by the present-day groundwater chemistry. It is especially possible to find out about variations in redox conditions /7-10/.

The presence of hematite and iron oxyhydroxide in conductive fracture systems, even at great depths, indicates that oxygenated water has existed at these depths. This has occurred under hydrothermal conditions and has resulted in hematite formation. During the final phase of such an event, oxyhydroxides may have formed. There is no evidence that oxygenated water has passed through the fracture systems under low-temperature conditions.

The occurrence and distribution of calcite-sealed fractures provides a good opportunity for checking the models for groundwater movements.

Since the carbon-dioxide-rich water dissolves calcite in the uppermost part of the rock, a much lower frequency of calcite-sealed fractures is found down to the depth where calcite dissolution ceases. On those sites where the water flux is very low, a decrease in calcite frequency is consequently not found. This is the case on Äspö.

## GEOCHEMICAL MODEL CALCULATIONS

### Natural Geochemical Conditions

Equilibrium modellings between groundwater and different minerals show how stable the studied groundwaters are. Since the studied equilibrium systems require different lengths of time to develop, it is possible to obtain a relative measure of the time during which the water and the minerals have been in contact with each other based on which minerals are in equilibrium with the water composition.

The PHREEQE and EQ3/6 programs are primarily used for the modellings. The PHREEQE code is relatively simple to use and is suitable for studying possible groundwater/mineral interaction. All groundwater data obtained are checked with respect to solubility for the most important minerals, for example calcite, gypsum, quartz, hematite, magnetite, goethite and pyrite /7-11, 7-6/. The EQ3/6 codes are more suitable for detailed studies of geohydrochemical processes /7-12, 13/.

### Conditions in the Near Field

In order to predict the chemical changes that can occur in the near field, geochemical model calculations are being carried out in cooperation with the University of Strasbourg. Three systems are being dealt with: bentonite clay/groundwater, bentonite clay/copper/copper mineral/groundwater and the importance of acids and bases for the bentonite clay.

Calculations have been carried out to determine the stability range of smectites and illites as a function of temperature and chemical composition /7-14/.

The effect of a heating of the rock to 150°C and the effect of high pH-values due to concrete in the repository have also been modelled /7-15/. Heating alone does not increase porosity, but heating in conjunction with high pH from concrete could bring this about. The results have been used in the assessment of the long-term stability of the WP cave repository /7-15/.

### 7.1.3 Research Programme 1990–1995

During the period 1990–1992, the continued research programme will be carried out primarily within the framework of the Hard Rock Laboratory. Following that, during the period 1993–1995, the programme will also include site investigations. The site investigations will use the experience from the Hard Rock Laboratory.

A base survey of the geohydrochemical conditions and a continuous follow-up of any changes that occur during the investigations or construction activities are required on each study site. Such follow-up is also taking place at SFR.

The hydrochemistry group within the Stripa Project has put together a proposal for how water and geochemistry conditions should be investigated /7-16/.

### GROUNDWATER TYPES

The occurrence of fresh and salt water will be studied in all future site investigations. Hydrochemical investigations will be carried out on every new site in at least two stages: first in shallow percussion boreholes and later in deep cored holes.

The classification of salt water will be further differentiated. An attempt will be made to distinguish between preglacial, synglacial and postglacial groundwaters in conjunction with the SKB 91 safety assess-

ment. Hydrochemical data primarily from Äspö, Finnsjön and SFR will be used, but also from other investigations.

### REDOX CONDITIONS

The redox level of the deep groundwaters is well defined and clarified. Their redox buffering capacity and the kinetics of the component reactions are, however, poorly understood. During the period 1990–1995, experiments will be conducted to measure the redox buffering capacity of the rock, to begin with empirically but eventually also aimed at understanding the underlying reactions.

### GROUNDWATER EXCHANGE TIME

Studies of different stable and radioactive isotopes in both the groundwater and fracture minerals will, together with the classification of the groundwaters, constitute the methods that can be used for the purpose of determining the origin of the water. Appropriate dating technique will hereby be used in the continued investigations. Great benefit can be drawn from the extensive studies of dating technique performed by the hydrochemistry group at Stripa /7-16/.

### FRACTURE MINERALS

Sampling and analysis technique will be studied in connection with the fracture mineral investigations, for example contamination by carbon-14 from the air in the calcite samples.

It is known from, for example, Klipperås that oxygen-containing water that is unsaturated with respect to calcite penetrates the upper levels of the bedrock. This results in a reduced frequency of calcite and an increased frequency of rust in superficial water-bearing fractures. The depth to which this leaching/oxidation takes place is dependent on the hydraulic gradient in the area, the water chemistry, the soil depth, the composition of the soil layer etc. Hence, all of these factors influence the redox conditions in the fractures in the bedrock. In this way, the frequency of rust and calcite in the boreholes provides information on the redox capacity of the bedrock.

Analyses of redox-sensitive elements such as Fe(II)/Fe(III), Ce(III)/Ce(IV) and Eu(II)/Eu(III) in the fracture minerals are utilized to interpret the redox conditions that have existed and currently exist in fractures in the bedrock.

The continued work with fracture mineral investigations is being focussed on:

- utilizing the presence and distribution of fracture minerals such as calcite, hematite, rust and pyrite to describe the hydrogeochemical environment in an area,



- making use of radiometric datings (uranium series analyses and C-14) to determine during which time periods different geochemical processes are taking place or have taken place,
- making use of tracer analyses of fracture minerals and combined fracture mineral/groundwater samples to describe the mobility of elements such as U, Th, rare earth metals, Cs and Sr. The sorption of different elements on the fracture minerals varies depending on varying water chemistry and type of mineral. This has been investigated in situ only at Klipperås. More areas should be examined in an attempt to validate co-precipitation and sorption studies performed in the laboratory.

## GEOCHEMICAL MODEL CALCULATIONS

Equilibrium models and reaction models will continue to be used to describe the measured chemical conditions in the rock-groundwater system. Model calculations of the geochemical evolution in the near field, eg water composition and mineral alteration, will continue. An increase in the use of coupled geochemistry-transport models is foreseen.

A special area where modelling will be done is acidification of precipitation. A low pH in the rain water may be of greater importance for the weathering of the rock than carbon dioxide absorption.

## 7.2 RADIONUCLIDE CHEMISTRY

### 7.2.1 Goals of the R&D Activities

The goals of the radionuclide chemistry investigations are as follows:

- measure and compile the basic chemical data required to describe solubility, inorganic speciation and co-precipitation of radionuclides in and outside the repository,
- determine possible contents, stability and mobility of dissolved radionuclides in the form of colloids, humic complexes and other aggregates, eg microbes,
- describe the interaction of radionuclides with rock and backfill material in the form of redox reactions, surface sorption and diffusion,
- determine the extent of radiolysis and its influence in the near field.

The first point is being carried out to a great extent in international cooperation, with an emphasis on measuring solubility constants and compiling the constants in a database. It is essential that the chemical data that are to be included in the safety assessment are internationally accepted, well documented and quality-assured to the required extent.

Further measurements are being made where necessary, and modern computer technology is being utilized for both storage of data and chemical model calculations.

The second point includes analysis and characterization of the aggregates, such as colloids, humic substances (humic and fulvic acids) and microbes present in the groundwater. It also includes experiments with the uptake and mobility of radionuclides in such form. Finally, it includes modelling of radionuclide speciation and transport properties, as far as this is possible.

The third point entails both laboratory experiments and model studies aimed at understanding the physico-chemical processes for retention in the rock and providing the transport models with retardation constants or submodels for surface sorption and diffusion. It is important to show that postulated reactions between radionuclides and minerals, eg reduction, actually take place.

Regarding the fourth point, good means exist for calculating the radiation field outside and inside a waste canister as a function of time. There is also a radiolysis kinetics model that provides a means of calculating the extent of radiolysis. Experiments are being performed to verify the validity of the model and to permit less conservative assumptions concerning the consequences of radiolysis.

### 7.2.2 Present-day State of Knowledge

#### SOLUBILITY, SPECIATION, CO-PRECIPI-TATION AND KINETICS

The solubility and speciation of radionuclides in the groundwater can be described with chemical equilibrium models based on thermodynamic constants. In order to obtain sufficiently good databases with equilibrium constants for the most important radionuclides, supplementary laboratory measurements are being performed both in Sweden and elsewhere around the world. An assessment of the present-day state of knowledge in the field is presented in Table 7-2.

The laboratory work in Sweden has been concentrated on uranium, thorium and their compounds with hydroxide and carbonate. The results have been published for the most part in scientific journals /7-17, 18/. For actinides such as neptunium and plutonium, the collaboration with French CEA has been important /7-19/. They have excellent facilities for conducting experiments with radionuclides. Hydrolysis complexes of uranium(IV) have been studied via thermal lensing spectrophotometry (TLS) in cooperation with the Ispra laboratory in Varese, Italy /7-20/.

Internationally, SKB is supporting the projects for collection and validation of thermodynamic data that are being conducted under the leadership of OECD/NEA (TDB) and CEC (CHEMVAL).

Table 7-2. An estimate of the general state of knowledge regarding chemical thermodynamic constants for dissolved inorganic complexes and solid phases of important elements in groundwater. A five-point rating scale has been used. Specific importance for a safety assessment must be judged from case to case.

ELEMENT	VALENCE	LIGAND <sup>C</sup>				
		OH <sup>-</sup>	CO <sub>3</sub> <sup>2-</sup>	HPO <sub>4</sub> <sup>2-</sup>	SO <sub>4</sub> <sup>2-</sup>	F <sup>-</sup>
U	VI	4a	4a	1b	4	4
	V		4a			
	IV	3b	2b	3	4	4
Th	IV	3b	2b	3	4	4
Pu	III	4	4a	3	3	2
	IV	3	2a	3	3	3
	V	2	3a	0	3	1
	VI	4	4a	1	3	4
	VII	2	2	0	0	1
Np	IV	2	2a	0	3	4
	V	4	3a	1	3	2
	VI	4	3a	2	4	4
	VII	2	2a	0	0	0
Am	III	5	3b	3	4	4
Tc	IV	1	0	0	2	1
La	III	5a	4a	2	4	4
Ce	IV	3a	4a	3	4	2

a The measurements were carried out with support from SKB by the Department of Inorganic Chemistry at the Royal Institute of Technology in Stockholm, either alone or in cooperation with CEA or ISPRA.

b Work is currently being done to improve the values, with support from SKB.

c Silicates have not been included but have been found to be of importance for eg U(VI).

The work with the thermodynamic database TDB, under the direction of OECD/NEA, has come farthest with regard to uranium. A special thermodynamic database for uranium, SKBU1 /7-21, 22/, has been compiled for SKB. It is used by the geochemical computer program EQ3NR. The compilation and testing of SKBU1 has benefited from the uranium chemistry experiments that have been conducted for a long period of time, as well as active participation in TDB and CHEMVAL. SKBU1 has been validated against independent experiments /7-22/. SKB's buildup of its "own" documented database is thereby proceeding according to plan.

Co-precipitation of lanthanides and actinides with uranium, and the importance of this phenomenon for the release and transport of radionuclides in the near field, have been investigated experimentally /7-23/. Thorium, lanthanum and barium were chosen as model substances for actinides and fission products, along with the main component uranium. Co-precipitation in connection with the formation of iron hydroxides and calcite has also been dealt with.

## ORGANIC COMPLEXES, COLLOIDS AND MICROBES

Groundwater samples from Stripa, Kamlunge and Svartboberget have been analyzed for their content of colloidal inorganic particles. The concentration of particulate material was generally below 0.1 mg/l. The highest value obtained was 0.4 mg/l. Undisturbed groundwaters are expected to have considerably lower concentrations /7-24/. Filtrations of saline groundwaters at Forsmark and Simpevarp that have later been carried out in the field with hollow fibre equipment indicate that these waters have very low contents of particulate material (considerably lower than 0.1 mg/l).

Formation and stability of inorganic colloids in the groundwater have been studied in situ at Fjällveden /7-3, 7-24/. Oxygenated water was pumped down into a water-bearing section at a depth of 468 metres in borehole KFFJ02. As expected, this caused a sharp increase of particles containing iron and sulphur. Pumping restored normal conditions in a few days, except for sulphur particles, which were still present at elevated levels after a week. The iron hydroxide particles appear to be sorbed on the fracture walls to a higher degree and not to participate in transport over longer distances.

Investigations of the capacity of inorganic particles to transport radionuclides are currently in progress.

Analysis of natural groundwater colloids and their ability to transport radionuclides is included in the studies of natural analogues, see Chapter 9.

Humic and fulvic acids have been isolated from deep groundwaters. The material has been concentrated, purified, analyzed and used in radionuclide chemistry experiments, see Table 7-3. A calculation model for ion binding by humic and fulvic acids has been developed at the University of New York in Buffalo /7-25/. Humic and fulvic acids are treated as polyelectrolytes in the model.

The importance of complexation between radionuclides and natural humic and fulvic acids has also been studied in cooperation with French CEA /7-26, 27/.

SKB is supporting the participation of a Swedish expert in CEC's international working group COCO. The group's task is to determine the importance of natural colloids and complexing agents for the transport of radionuclides.

Microbes in deep groundwaters have been analyzed by sampling with the mobile field laboratory and special sampling in situ with the chemistry probe. A so-called "gas sampler" has been used for the latter purpose. Deep groundwater has been found to contain microbes at concentrations of between 10<sup>5</sup> and 10<sup>6</sup> bacteria per ml /7-28/. Microbes in groundwater and on minerals and their potential importance for radionuclide migration and geochemistry are also being dealt with within the frame of the Poços de Caldas project, see Chapter 11. The same applies to transport of radionuclides with particulate material and organic complexing agents.

**Table 7-3. Analyses of fulvic acids from superficial and deep groundwaters.**

Site	Bersbo	Fjällveden	Finnsjön	Gideå
Depth (m)	Surface water	409	232	107

### INORGANIC CHEMISTRY OF THE GROUND-WATER

pH		5.3	7.5	7.7	8.8
Eh(mV)		—	-110	-270	-10
HCO <sub>3</sub> <sup>-</sup>	(mg/l)	5.5	170	260	161
SO <sub>4</sub> <sup>2-</sup>	(mg/l)	36	0.2	140	0.8
F <sup>-</sup>	(mg/l)	<0.1	0.7	2.3	2.6
Cl <sup>-</sup>	(mg/l)	7.2	7	1500	4.4
Na <sup>+</sup>	(mg/l)	5.8	32	650	49
Ca <sup>2+</sup>	(mg/l)	8.3	21	320	10
K <sup>+</sup>	(mg/l)	1.8	2.5	8.7	2.2
Mg <sup>2+</sup>	(mg/l)	8.6	0.4	40	2.6
Age <sup>14</sup> C carbonate (years)		—	4235	8090	6450

### CHEMISTRY OF THE FULVIC ACIDS

Molecular weight MW	2650	1700	2650	1600
C (%)	52.5	50.8	53.0	53.7
H (%)	3.6	3.9	3.8	4.4
N (%)	1.1	1.7	0.9	0.5
O (%)	38.8	39.7	36.2	37.5
S (%)	1.0	0.8	1.1	0.5
Ash (%)	3.0	3.1	5.0	3.4
Acid capacity in water (meq/g)	4.65	5.14	4.98	5.42
Age <sup>14</sup> C (years)	—	1270	4610	5250

### SORPTION AND DIFFUSION

Investigations of radionuclide diffusion in bentonite and diffusion of radionuclides into the micropores of the rock have continued. Diffusion of the fission products strontium, technetium and cesium as well as the actinides thorium, protactinium, uranium, plutonium and americium in compacted bentonite has been measured, interpreted and reported /7-29/. The importance of the speciation of the nuclides in the interstitial water in the clay has been established in the tests. Thus, for example, technetium diffuses ten times more slowly under reducing conditions.

Diffusion of radionuclides in sand-bentonite mixtures is being studied experimentally.

Diffusion in rock has been measured with radionuclides of strontium, technetium, iodine, cesium, neptunium, plutonium and americium /7-30/. The pieces of rock had been taken from drill cores in granitic rock at Finnsjön, Stripa and Studsvik. The measured diffusivity varied between about  $10^{-13}$  and  $10^{-15}$  m<sup>2</sup>s<sup>-1</sup>, depending on the nuclide. How different minerals and fracture minerals sorb different nuclides can also be seen.

Using concrete in existing or future alternative repository concepts may prove to be advantageous for dif-

ferent reasons. The chemical experiments with concrete and radionuclides have therefore been continued. Laboratory tests are being conducted with diffusion in concrete and diffusion from concrete to bentonite. The chemical alteration of concrete with time will also be investigated.

Bentonite with additives, known as getters, has been investigated experimentally. A series of different compounds has been tested. Additives that have a reducing action have been found to have a favourable retarding effect on the diffusion of redox-sensitive radionuclides.

Sorption experiments have been conducted with radionuclides of sodium, strontium, cesium and europium /7-31/. Sorption on crushed fracture filling material and crushed granite was compared with sorption on intact fracture faces. The experiments were conducted to obtain supplementary information to augment the laboratory investigations of radionuclide migration in over-cored rock fractures. The latter experiments are a part of the validation of transport models for describing radionuclide migration in rock.

Sorption tests are also being conducted to see the effect of different liquid/solid phase ratios and the importance of having a mixture of radionuclides.

The surface complexation theory is being tested as a model for describing sorption and diffusion of radionuclides on mineral surfaces. The method has previously been applied with success to sorption on clean oxide surfaces. Experiments will be conducted in order to test sorption on mineral surfaces.

### RADIOLYSIS

The production of hydrogen in compacted, water-saturated bentonite as a result of irradiation with alpha particles has been measured experimentally and compared with theoretical calculations that use homogeneous reaction model for radiolysis /7-32, 33/. Relatively good agreement was obtained.

Experiments have also been carried out to determine the propagation of a redox front in compacted bentonite as a result of alpha irradiation /7-34/, see Figure 7-1. Here as well, relatively good agreement was obtained with calculated values. It was further found that only a fraction of the bivalent iron in bentonite is available for reaction with radiolytically produced oxidants.

Experiments and theoretical calculations have also been carried out for the radiolytic production of oxidants in connection with alpha radiolysis of simulated groundwater /7-35/. The production of hydrogen peroxide has been analyzed and the influence of groundwater components such as chloride, carbonate and bivalent iron ions has been determined. Agreement between calculations and experiments has been relatively good.

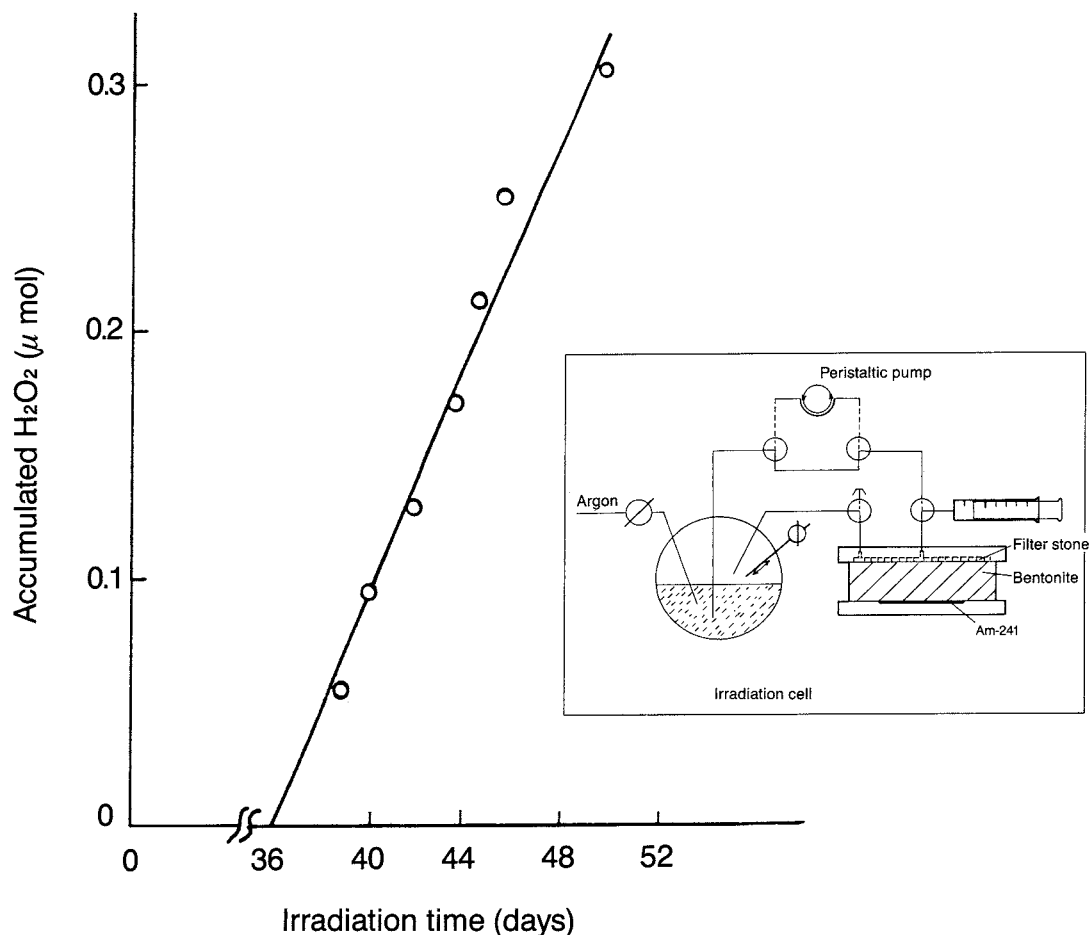

Figure 7-1. Irradiation of compacted water-saturated bentonite with alpha particles. The breakthrough of radiolytically produced hydrogen peroxide is plotted as a function of time.

### 7.2.3 RESEARCH PROGRAMME 1990–1995

#### SOLUBILITY, SPECIATION, CO-PRECIPITATION AND KINETICS

Continued measurements of thermodynamic constants for actinides in natural water systems will be carried out. Liquid extraction technique will be tried for measurements of uranium and plutonium hydroxide complexes. The initiated investigations of phosphate complexes will be completed. Determination of equilibrium constants by measurements or critical review of existing values is an important ingredient in the gradual buildup of SKB's thermodynamic database.

The reduction of redox-sensitive radionuclides, such as technetium, proceeds sluggishly, which makes it difficult to interpret different experiments, such as sorption and migration tests under natural reducing conditions. Kinetic tests are therefore planned.

The co-precipitation tests will continue. Co-precipitation in connection with calcite formation and the formation of iron(III) oxides will especially be tested.

The chemistry of the actinides is different in a concrete environment due to the chemical conditions. Compared with natural water, the pH is high and the carbonate content low. This will be investigated.

#### COLLOIDS, HUMIC COMPLEXES AND MICROBES

Sampling and analysis of such substances in natural groundwaters will continue to play a very important role. Additional experiments with radionuclides, radionuclide-like substances and humic substances will be carried out.

Tests with radionuclides and colloids, as well as tests with radionuclides and microbes, will be conducted.

The emphasis in the investigations will lie on natural organic complexing agents such as humic and fulvic acids. It is hoped that more work can be done on colloid transport.

In-situ investigations are planned in connection with the operating phase of the Hard Rock Laboratory.

## SORPTION AND DIFFUSION

Laboratory tests with sorption and diffusion of radionuclides in rock material will continue. An important task is to test more advanced models for sorption and diffusion that include surface diffusion, surface complexation, surface reactions etc. The aim is to achieve a greater understanding of the phenomena and development of submodels that can be used in the transport models.

The laboratory tests with sorption and diffusion in concrete will shed light on the possible advantages or consequences of using concrete in a repository for high-level waste. The tests are intended to determine the impact of the concrete on the environment and the concrete's own chemical and structural alteration with time.

The tests with additives known as "getters" to a bentonite buffer will continue. An initial step has been taken to find substances which can be shown by experiments to have a favourable effect. The next step is to choose among these substances the ones that are feasible to use. It then remains to prove that the proposed additives cannot affect the buffer, the canister or other near-field components negatively during the very long period of time the barrier function must be maintained.

## RADIOLYSIS

The radiolysis kinetics model needs to be further tested. More fundamental tests and variation analyses may prove to be necessary. An important point that remains to be dealt with is the influence of the fuel surface on the chemical process of radiolysis, see also Chapter 3.

## 7.3 CHEMICAL TRANSPORT AND VALIDATION OF TRANSPORT MODELS

### 7.3.1 Goals of the R&D Activities

The goal is to develop and validate the models that are used to describe release, dispersal and retention of radionuclides from a final repository, as well as the changes in the near field, for example the creation of a redox front due to radiolysis.

Validation of chemical transport models shall be accomplished by means of:

- laboratory tests,
- tracer tests,
- study of natural analogues.

### 7.3.2 Present-day State of Knowledge

The transport of solutes with the natural groundwater flow in rock is described with calculation models. This

transport modelling is based on calculations of the water flow and a description of the distribution of the flow in the rock. The distribution of the water flow between different water-bearing fractures and in the fractures themselves is of very great importance for the dispersal of solutes in the groundwater. The existence of preferential flowpaths, known as channels, can reduce the transport times and also diminish the retention of dissolved radionuclides through a reduction of the contact surface area with the rock. This has been described thoroughly /7-36/ and has also been used as a point of departure for conservative hypotheses within safety assessments performed for SFR and WP Cave.

## TRACER TESTS

Tracer tests can be regarded as larger-scale interference pumping tests. Besides pressure responses, ie connectivities, the length and transport capacity of the flowpaths is obtained. In actuality, tracer tests are the only method that can be used to determine the travel times of the water between two points and thus check the validity of the models for water flux devised on the basis of hydrotests. The extreme cases are that the water moves in a single channel, and that it flows in a homogeneous porous medium. On a large scale, the porous model is fully acceptable, while on smaller scales channelling must be taken into account.

Tracer tests have been carried out on different scales, at Finnsjön and at Stripa. The tests carried out at Stripa have mainly focussed on transport in the good, low permeable, rock, while tracer tests at Finnsjön have focussed on a horizontal fracture zone of high conductivity. The results of the tests have also been different. The transport at Finnsjön can very well be described by a porous continuum model, while the transport at Stripa points toward strong channelling.

The channelling model for water flow in an individual fracture has been dealt with in /7-37/. A two-dimensional statistical model has been used to simulate a water-bearing fracture /7-38/. Water flow and solute transport in the fracture have been modelled for different realizations of the model fracture.

### Tests at Stripa

Tracer tests with non-interacting tracers are being conducted in the Stripa mine within the framework of the international OECD/NEA project, see chapter 10. The migration distance has varied between about 1 and 50 m. Longer transport distances have been observed in one case. An important goal has recently been to demonstrate the distribution of the water flow over the fracture faces and between different fractures.

Radar measurement days have been used successfully at Stripa to follow the flow of salt water injected in water-bearing fractures between boreholes.

A series of experiments at Stripa for the purpose of validating the presence of an interconnected pore system in low-conductivity rock has now been concluded

and the results reported /7-39/. The experiments began back in 1982. A mixture of three non-interacting tracers – Uranine, chromium-EDTA complex and iodide – was injected into intact granitic rock during periods of 3 months, 6 months and 3.5 years. Sampling showed that in the test that had been going on the longest, tracers had penetrated at least 400 mm into the rock, see Figure 7-2. The results of all three experiments show that all three tracers had migrated through the affected zone near the injection hole, through the fracture filling mineral and further into the undisturbed rock. The conclusion is therefore that solutes can diffuse into the rock matrix and the radionuclide can be absorbed and retained by the rock in this manner.

### Tests at Finnsjön

Tracer tests in a large, interconnected fracture zone are being conducted at Finnsjön. The flat fracture zone is about 100 m wide and is located at a depth of between

100 and 300 m in the area. A detailed geophysical and hydrological survey preceded the tracer tests. The tracer tests at Finnsjön can be regarded as a chain of investigations that together make up a picture of the groundwater flow in the investigated zone. So far, an interference pumping test, a radially convergent tracer test and a dipole test have been carried out. The evaluation of the radially convergent test is complete, while the evaluation of the dipole test has only begun. Before each new test, a prediction has been made on the basis of the previous results. Data from pre-investigations and tracer tests at Finnsjön are made available for independent evaluation by other scientists and groups through the INTRAVAL study.

### Tests at Hylte

Methods for carrying out tracer tests in a fracture zone that intersects a tunnel are being developed in connection with in-situ tests at Hylte.

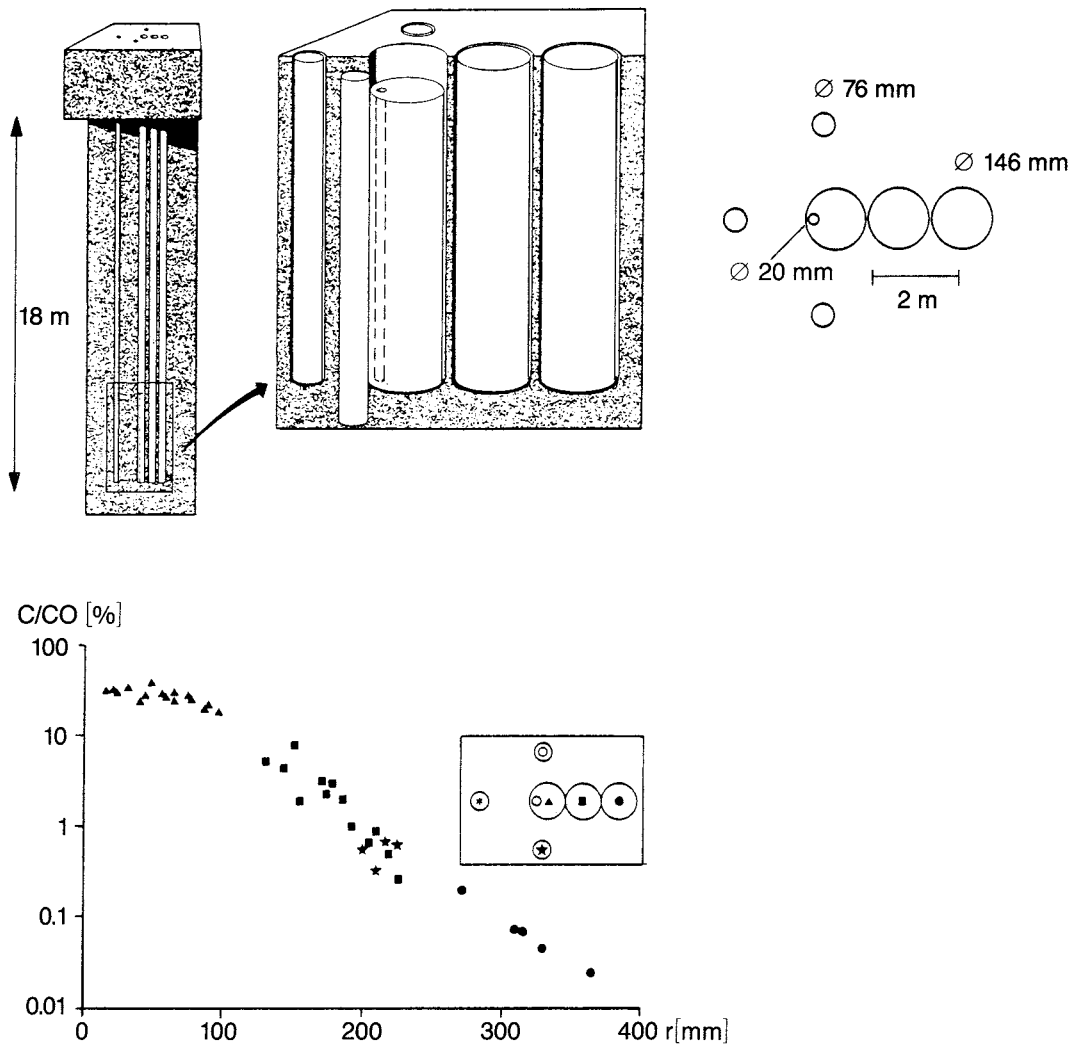

Figure 7-2. The figure shows how the original injection hole has been overcored for sampling of the rock after 3.5 years. A number of additional sampling holes have been drilled in an array around the injection hole. The boreholes extend from the floor in a tunnel at Stripa on the 360 m level. An example of the results of the analyses is illustrated by the points in the graph, which show how iodide ions have penetrated out into the rock from the injection hole.

## Tracers

The tracers can be classified on the basis of their chemical properties, non-interacting and sorbing, and on the basis of their character, dyes, metal complexes and ions. A further subdivision can be made between stable and radioactive tracers.

Radioactive tracers can be handled in much lower concentrations than equivalent stable tracers. They also have the advantage that they disappear after some time so that the same tracers can be used in later tests. At Finnsjön, radioactive tracers have been used in the dipole test.

Non-interacting tracers can be used in large-scale tracer tests, while the weakly sorbing substances can only be used in tracer tests over short distances. Metal complexes and dyes tend to be non-interacting, while all ions, and especially cations, are sorbing.

During 1988 and 1989, a great deal of work has been devoted to screening out suitable tracers and testing them under the specific conditions prevailing in tests where they will be used. A testing procedure for tracers has been developed in this manner. It has been found that site-specific conditions are of great importance for which tracers can be used.

## COUPLED TRANSPORT MODELS

Advanced models that couple transport with geochemical reactions have been tested and applied /7-40/. An important application has been the calculation of the chemical interaction between bentonite and concrete with the computer code CHEMTRN developed at Lawrence Berkeley Laboratories in the USA /7-40/.

Coupled transport-geochemistry models are also being developed to simulate the migration of a redox front /7-41/.

## LABORATORY TESTS

Drill cores are being taken so that they contain a natural fracture along the axis of the core. Such overcored rock fractures are being used for migration tests and flow tests in the laboratory.

The results are used to validate transport models. Data from previous tests are being compiled to be included as a case in the international project INTRAVAL under the direction of SKI. In this way, transport models can be tested, and possibly validated, by different, independent groups.

A well-sealed system containing a drill core with a natural fracture and equipment for injection and sampling has been developed to permit simulations to be carried out of migration under natural reducing conditions. The transport of technetium has been studied with this equipment, see Figure 7-3, /7-42/.

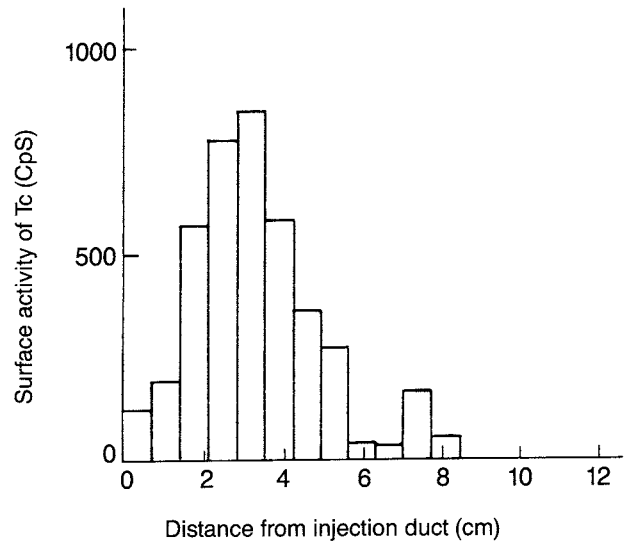

Figure 7-3. Distribution of technetium on a fracture face in granite after 50 minutes of elution. The test was carried out under reducing conditions created with simulated groundwater and crushed rock.

## NATURAL ANALOGUES

Studies of natural analogues of release and transport of radionuclides have been concentrated to the Poços de Caldas project, see Section 11.1. Efforts outside the project are aimed at simplifying and supporting the model treatment of data from the project. Examples of such supportive activities that are directly linked to the Poços de Caldas project are the development of coupled models for migration of the redox front and geochemical modellings of the composition of the groundwater and of the chemistry of the radionuclides in the groundwater.

### 7.3.3 Research Programme 1990–1995

## LABORATORY TESTS

Experiments with radionuclide transport in overcored open fractures will continue. The importance of reducing conditions and the available flow area over the fracture surface will continue to be important questions. Special efforts will be made to clarify the impact of reduction kinetics on the tests.

Greater efforts will be made to validate models for consumption of oxidants, reduction of actinides, coprecipitation and bacterial influence. During the operating phase in the Hard Rock Laboratory, a num-

ber of in-situ tests are planned to study conditions in connection with release and migration of radionuclides. Prior to and during the migration tests in the Hard Rock Laboratory, laboratory tests will be initiated within the chemistry programme to prepare and support the underground experiments. This will most likely be a major activity that will engage a large portion of the 1990–1995 chemistry programme.

## TRACER TESTS

Additional tracer tests with non-interacting tracers will be conducted within the Stripa Project and in the Hard Rock Laboratory. A continuation of the tracer tests at Finnsjön is currently being discussed. For the Hard Rock Laboratory, the aim is to carry out tests with sorbing substances as well, test the reducing properties of the rock with respect to oxygen and redox-sensitive radionuclides, and test the transport of colloidal and complex-bound radionuclides.

During the period 1990–1995, tracer tests will mainly be conducted in the Hard Rock Laboratory. The purpose and scope of these tests are described in Chapter 9 and are only briefly outlined below.

- A large-scale tracer test during the construction phase and during the operating phase will shed light on how the water moves over distances of 100 – 500 m. A large number of inflow points and injection points will be utilized.
- A block-scale tracer test during the operating phase will describe the movement of the water in the good, low permeable, rock and in fracture zones on a scale of 10 – 50 m.

As a conclusion of the Site Characterization and Validation Test at Stripa, tracer tests will also be con-

ducted. They will influence the design of the block-scale tracer test in the Hard Rock Laboratory.

## TRACERS

During 1990, a tracer manual will be compiled on the basis of the results obtained from the tests at Finnsjön and Hylte. Questions to be dealt with include:

- Which tracers can be used in the tests?
- When can the different tracers be used?
- In what sequence should the tracers be used?
- Which tests should be performed before the tests?

An important part of the work involves defining the sorption properties of the weakly sorbing tracers, since they can be used to some extent to distinguish the different conceptual models.

## NATURAL ANALOGUES

In collaboration with England (UK DoE), Switzerland (NAGRA), the USA (US DOE) and Brazil, a study of natural analogues is being conducted at Poços de Caldas in Brazil. The work was begun in May 1986 and is scheduled to continue until March 1990, see also Section 11.2.

SKB is following the Alligator Rivers project, ARAP (Alligator Rivers Analogue Project), by participation in the INTRAVAL project, where data from both the Poços de Caldas project and the Alligator Rivers project are being processed with broad international participation. SKB is currently discussing with the Canadian organization AECL the possibility of participating in the Cigar Lake project in Canada, to begin with during a three-year period starting in 1989.



# 8 METHOD AND INSTRUMENT DEVELOPMENT

## 8.1 GOALS OF THE R&D ACTIVITIES

By “methods and instruments” is meant in this chapter measuring methods for the collection of geological, geohydrological, geophysical, geochemical and rock-mechanics parameters for the characterization of a rock volume, as well as measuring instruments used for this data collection. How the methods are applied in SKB’s geoscientific research has been described in Section 6.2.2.1.

The goal of method and instrument development is to ensure that suitable methods and instruments are available for high-quality collection of such measurement data as are required for the characterization of a rock volume for a final repository and for assessment of the safety of such a final repository for radioactive waste.

While the principal method development takes place within the framework of different projects, the instrument development is usually pursued in the form of special development projects.

## 8.2 PRESENT-DAY STATE OF KNOWLEDGE

Knowledge of the properties of the rock at depths that may be considered for a Swedish final repository for radioactive waste, about 500 m or more, was relatively limited in the mid-seventies, especially as regards crystalline bedrock.

Boreholes for oil and gas exploration had mainly been drilled in sedimentary bedrock. Water prospecting constituted a limited source for data collection given the small depths, 50 – 150 m. Prospecting for minerals and ores extended to greater depths, but had been limited to a small number of ore fields in Sweden. The data collection was usually concentrated for natural reasons to rocks and structures that were of importance for clarifying the origin of the ores.

In response to commercial needs, efficient core drilling rigs had been developed so that continuous rock samples, drill cores, could be retrieved from the penetrated rock volume for inspection. Geophysical logging was relatively well developed for oil prospecting in sedimentary bedrock, but was still in its cradle as far as crystalline bedrock was concerned. Geophysical measurements from the surface, on the other hand, had been developed into relatively useful aids.

Hydrological methods had begun to be used at a relatively early stage within groundwater prospecting for determination of the water-bearing and water-storage

properties of the rock, but with the limitation that they applied for homogeneous aquifers, usually water-bearing strata in sedimentary bedrock. These methods were then further developed in connection with calculations of the volume content of oil reservoirs etc and subsequently came to constitute a basis for the geohydrological methods in crystalline bedrock as well.

The great proliferation of research on the final disposal of radioactive waste that took place during the latter half of the seventies led to great advances within the field of measuring methods and instruments. Geophysical methods and instruments have come to be important tools and great progress has therefore been made in this area, especially with regard to measurements from boreholes.

As far as geohydrological methods are concerned, SKB has invested a great deal in developing suitable methods for the difficult task of characterizing the water’s occurrence and flowpaths in a crystalline bedrock, with its complex pattern of fractures. Method development within geohydrology has also led to great efforts to develop suitable measuring instruments.

### 8.2.1 Measuring Methods and Instruments for Surface Investigations

This summary of the present-day state of knowledge regarding methods and instruments for surface investigations will not deal with methods for obtaining satellite pictures, aerial photographs, topographical and geological maps, even though such information is of great importance for SKB’s georesearch.

As far as airborne geophysics is concerned, methods exist for the measurement and production of magnetic maps, radiation maps, electromagnetic maps etc of high technical quality /8-1/. At the same time, it can be noted that such surveying activities, which in combination with geological surveying are of great importance in the nationwide resource planning, have been sharply reduced in recent years, mainly due to cutbacks in government funding.

A large number of geophysical measurement methods are available for measuring from the ground surface /8-2,3/. Electromagnetic methods (Slingram and VLF) are also of great importance for determining the location and extent of rock blocks and fracture zones from the ground surface. In the other contexts, electrical measuring methods can be decisive. Among acoustic methods, seismic refraction and seismic reflection surveys are best suited for detection of crushed zones at small and great depths. The radar method, previously developed for borehole measurements, should, after

modification, be a valuable tool for ground measurements as well. The possibilities for further development are judged to be great for both seismic and radar methods, both for measurements between boreholes, tunnels and the ground surface and for interpretation methodology.

Valuable contributions to the interpretation of both airborne geophysics and ground geophysics have been made recently with the development of image processing technology. A great development potential still exists within this field.

## 8.2.2 Measuring Methods and Instruments for Investigations in Boreholes

The measuring methods and instruments that are available for data collection from boreholes are described in this summary. Unless otherwise stated, measurements can be made in boreholes with a diameter of 56 mm or larger, and the technique works in 1000 m long (deep) boreholes /8-5/.

### 8.2.2.1 Drilling

As mentioned previously, core drilling constitutes the backbone of SKB's drilling activities. Most of the drilling is done with a diameter of 56 mm, while a diameter of 76 mm is used in special cases, for example when special measurements so require. During core drilling, drilling water is pumped down into the borehole for the purpose of cooling the drill bit as well as flushing up the drill cuttings that are produced. Both the drill cuttings and the drilling water have some adverse effect on the measurements performed in the borehole. Some of the drilling water is pressed out into the fractures in the rock and can disturb the chemical analysis of water samples. Some of the drill cuttings also penetrate into the fractures and can interfere with the hydrological measurements. In order to keep track of these effects, a tracer is added to the drilling water so that the water that is subsequently sampled can be checked for the presence of any residual drilling water.

SKB has developed a modified coring technique whereby a drawdown is created in the hole by pumping, see Figure 8-1. This prevents or at least reduces the penetration of drill cuttings and drilling water into the fractures in the rock. In order to make this possible, the uppermost 100 m or so of the borehole is drilled with a larger diameter so that air-lift pumping can then be carried out from this part of the borehole ("telescopic borehole").

Percussion drilling is used as a complement to coring, preferably where 100 – 200 m deep holes are required. In this drilling method as well, geohydrological and chemical measuring methods have been integrated during the drilling process in order to optimize data capture. The percussion drilling technique for depths

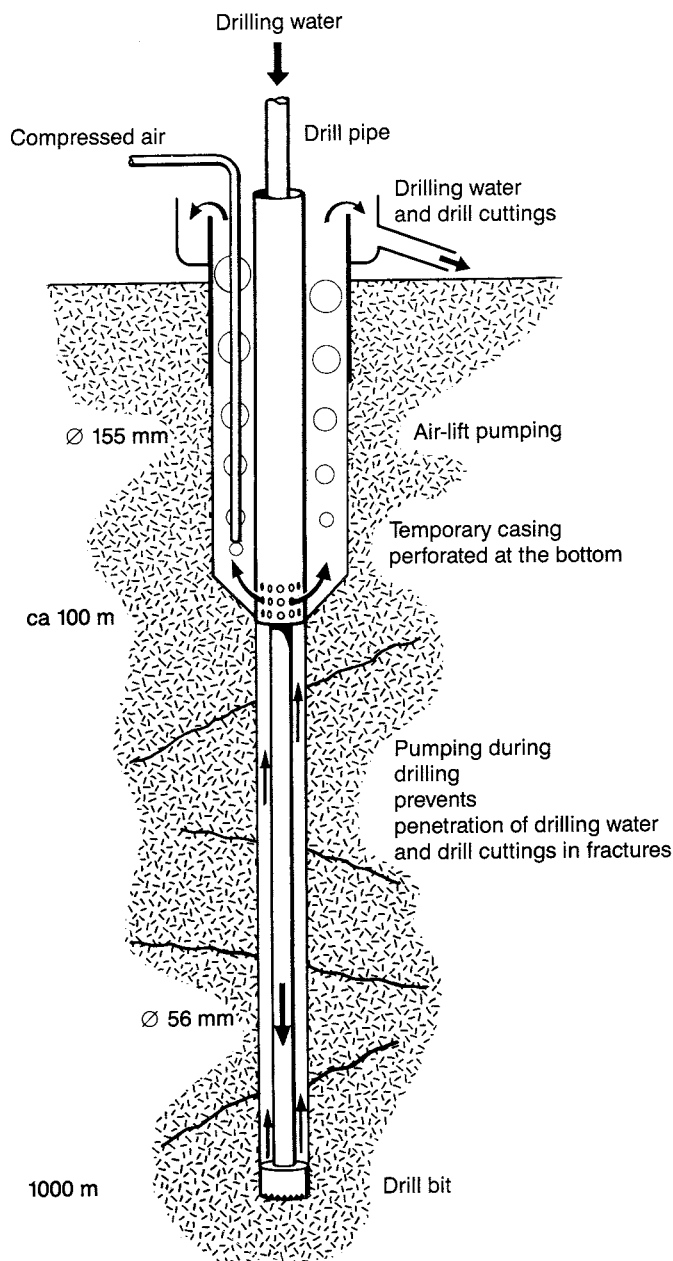

Figure 8-1. Drilling of telescopic boreholes.

greater than 100 – 200 m has been developed with the aid of high-capacity air compressors. The greatest motive for this type of drilling is to avoid contamination of the groundwater with drilling water. The method has been found to work well for water recovery down until a highly water-bearing zone is penetrated. A heavy inflow of water prevents effective water extraction, with the consequence that the groundwater becomes contaminated with air and oxygen.

### 8.2.2.2 Mapping of Drill Core and Borehole

In mapping of the drill core, it is important not only to classify the rock types but also to map the structures in

the bedrock as well as the appearance and direction of the fractures. It should be determined whether the fractures have formed naturally, whether they have been sealed by fracture minerals or whether they have been created in connection with the drilling work. Fracture minerals are mapped and the material is processed statistically to determine, among other things, correlations between fracture directions and fracture minerals /8-6,7/. To assist in this mapping work, a computerized mapping instrument has been specially devised to facilitate statistical processing and data presentation. Determining the three-dimensional direction of fractures from the drill core is a difficult task. Different orientation methods are available, but most are time-consuming and/or relatively unreliable.

Borehole TV and televiewer are two methods that can be used to orient individual fractures directly in the borehole. Borehole TV is currently only available for inspection down to a depth of 500 m. Orientation is done with the aid of a built-in compass and inclinometer. With the right illumination, the method has the advantage of providing a visual picture of the borehole wall, but the orientation work requires considerable manual labour. The method does, however, have great potential for development both toward great depths and toward automatic orientation via image processing. The televiewer is another instrument that is lowered into the borehole to scan the borehole wall by means of ultrasound. This method has recently been developed so that it can be used in boreholes as small as 56 mm, which was recently tested within the Hard Rock Laboratory Project. The method's data presentation is well developed so that the direction of the fractures can be determined relatively easily.

### 8.2.2.3 Geophysical Measurements in Boreholes

#### Geophysical Borehole Logging

Geophysical borehole logging is a method that is used routinely in connection with SKB's site investigations. These measurements supplement core mapping, but can also be used in percussion boreholes where there is no drill core to study /8-7/. It can be impossible to determine whether a fracture or fracture zone is open and water-bearing by means of mapping of the drill core alone, but here geophysical logging methods can indicate water content. These methods include measurement of the resistivity and temperature of the borehole liquid, while the two radioactive methods neutron and gamma-gamma (above all in combination) can provide an indication of porous units (eg fracture zones) and of high-density rock types (eg greenstone dykes). Measurement of natural gamma radiation is especially useful for distinguishing different rock types. A number of electric logging methods are available and are used primarily to detect fractured rock or individual fractures. Other measuring methods build on the varying

elasticity and magnetization of the rock. Combining the results of different measuring methods is an area where progress is being made through improvements in processing and presentation techniques.

#### Borehole Radar

Physical methods that have undergone considerable development recently are borehole radar and borehole seismic. Radar technology, whose most common and well-known application has been for the surveillance of air space as well as air and marine safety, has also been developed over the past couple of decades for measurement of soil strata from the ground surface. A great step forward was made when the radar method was developed for use in rock investigations in boreholes /8-8/. The method entails sending electromagnetic pulses with frequencies in the range 20 – 100 MHz out into the rock volume around the borehole. Differences especially in the rock's electrical, but also magnetic, properties are manifest in the form of reflection surfaces or attenuation of the signal until it returns to the signal receiver. The method has been refined to a high degree within SKB projects, especially the international Stripa Project. It can be performed today in the form of both single-hole measurements and cross-hole measurements. The radar instrument is of a high technical level and the measurement results are presented in the form of images where, for example, fracture zones and rock dykes appear as flat structures or as tomograms where the velocity distribution or signal attenuation attest to anomalous bedrock conditions.

The method's resolution is on the order of a wavelength, ie 2 – 6 m. Anomalous objects that have this length in at least one dimension can generally be regarded as detectable /8-9/.

The radar method is still under intensive development. Directional antennas are being developed to permit the direction to a reflecting structure to be determined. One of the big advantages of the radar method is that it detects structures even outside the immediate vicinity of the borehole, in contrast to the geophysical logging methods described above. Under favourable conditions, structures can be followed at distances of more than 100 m from the borehole.

Radar measurements are sensitive to the resistivity of the rock volume. When pores and fractures are filled with salt water, the radar signal is greatly attenuated, which means that its range is greatly reduced. However, the highly attenuating properties of salt water can also be used to advantage by, for example, injecting salt water into a fracture zone that is originally filled with fresh water. Differences in the radar images before and during salt water injection are used to determine whether, and in which units, a fracture zone is water-bearing. This measuring technique has been tested and constitutes an example of the development potential of radar methodology and of how combined testing methods can improve characterizations of rock volumes.

## Borehole Seismics

Another geophysical method that has been developed to a considerable extent is seismology. Seismic methods are based on the fact that the propagation and reflection of acoustic waves reflect the elastic properties of the medium. The speed of propagation of the seismic waves is determined in order to obtain a measure of the degree of fracturing of the rock. Thus, the wave velocity in fracture zones is low, while in sound rock it is high.

Seismic methods have long been used in the form of refraction seismic surveys and reflection seismic surveys from the ground surface. Another seismic method that has undergone rapid development recently is borehole seismics, which, like borehole radar, can be used either as a single-hole method or as a cross-hole method with measurement results in the form of a reflection diagram or a tomogram, respectively /8-10/. Great efforts have been made to improve the seismic transmitter, eg by the introduction of piezoelectric transmitter elements that give the transmitted wave a known frequency spectrum, which in turn simplifies the analysis of the returning waves. As with radar, most of this development work has been, and is still being, conducted within the framework of the Stripa Project.

Other applications of seismology are VSP, Vertical Seismic Profiling, and Tube Wave, both of which are based on wave propagation from the ground surface to boreholes. VSP is mainly used to detect structures that penetrate boreholes, and in particular more or less horizontal ones, although structures below the bottom of the hole can also be identified. The method often constitutes a calibration method for reflection seismic surveys from the ground surface. Tube Wave measurements are basically conducted in the same manner, but in this case the arrival of so-called tube waves is analyzed. These waves arise where the borehole intersects a water-filled fracture when the fracture is brought into oscillation by the primary elastic wave /8-11/. The tube wave then propagates along the borehole and is detected with hydrophones. The purpose of the method is to detect open fractures or fracture zones.

### **8.2.2.4 Geohydrological Measurements in Boreholes**

Geohydrological measuring methods for use in boreholes have undergone extensive development. Passive methods entail measurement of natural conditions (pressure and flow), while active methods involve measuring the response of an artificial disturbance in the groundwater reservoir.

#### Hydraulic Measurements

An initial hydraulic measurement can be made in connection with the drilling operation. This is especially true for percussion drilling, where the rate of recovery (the rate at which the water table returns to its original level) is measured when drilling is concluded. The same

type of measurement can also be made in connection with core drilling, but then special interruptions are made when air-lift equipment is lowered and the 100 lowermost metres are sealed off by a packer. Recovery measurements, which provide a general picture of the hydraulic properties of the borehole in 100 m sections, are an example of combined measurements, since water samples are taken at the same time.

Hydraulic injection test is a measuring method that is often used to determine hydraulic conductivity /8-12/. The method involves inflating 2 packer seals to seal off one borehole section at a time and measure how much water can be pressed out into the fractures in the rock. Water pressure, the length of the measurement section and the measuring time can all vary widely. In SKB's investigations, a section length of 3 and/or 30 m is normally used. In the former case, the measurements are normally performed with an injection time of 15 min, while 2 hours is used for 30 m measurements. SKB has made great efforts to develop practical instruments with good accuracy for these measurements. Thus, for example, an umbilical hose system have been designed that perform the measurements fully automatically under computer control /8-5/. With another equipment, called the pipe string system, the water injection is controlled manually while data collection is performed by a computer. The tests are usually carried out at an injection pressure of 2 bar. Flow values within the range 0.5 ml/min to about 20 l/min can be measured, and pressure changes on the order of 1 cm H<sub>2</sub>O should be able to be recorded at a depth of 1000 m. The measuring range for hydraulic conductivity is about  $10^{-4} - 10^{-11}$  m/s for the pipe string system, but this is dependent on section length and measurement time.

When the hole has a large enough diameter to accommodate a submersible pump, pumping tests can be carried out. Like an injection test, a pumping test constitutes a hydraulic disturbance whose effect is recorded. Usually, however, water is pumped from a whole borehole, which means higher capacity. It is also usually carried out during a longer period (days-weeks-months). If more boreholes are present in the vicinity, the groundwater table is measured in them, and these holes can also be sectioned off by means of packer seals. Such measurements are called interference tests or cross-hole measurements and have the great advantage of reflecting the hydraulic conditions within a larger area. A special type of cross-hole measurement has been tested in the Hard Rock Laboratory Project; water was pumped from packer-sealed borehole sections in the previously described telescopic boreholes with a large-diameter upper section /8-13/. With this special type of measurement, the question of whether fracture zones are hydraulically interconnected between the different boreholes can be determined with greater certainty.

A new hydraulic method has been tested for the first time within the Hard Rock Laboratory Project /8-12/. Flow meter logging has been carried out during pump-

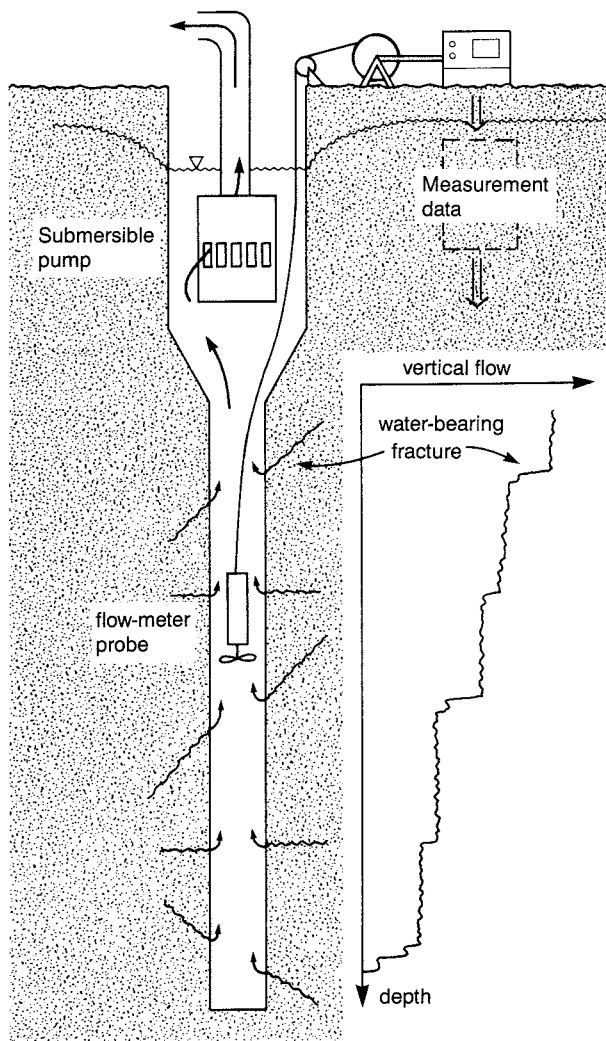

Figure 8-2. Flow-meter logging during pumping indicates water-bearing fractures or fracture zones.

ing from cored holes, see Figure 8-2. Flow meter logging entails lowering a probe with a built-in propeller or other flow sensor to measure the vertical water flow in the borehole. The resolution of this probe is not sufficient to record natural vertical flows, but by using it in connection with pumping it is possible to detect the borehole levels (fractures or fracture zones) where water inflow is taking place. The method has proved highly useful for quickly obtaining qualitative data on the conductive parts of the boreholes. Its resolution is dependent on the diameter of the borehole and the capacity of the pump, but in 56 mm boreholes, sections with a transmissivity greater than  $10^{-7} \text{ m}^2/\text{s}$  can be detected.

### Groundwater Head

The pressure or head of the groundwater can be measured in a number of different ways and for a num-

ber of different purposes. It can be measured by means of sounding of the groundwater surface in an open borehole. In deep boreholes, several borehole sections are often sealed off with packers so that the groundwater heads can be measured in each enclosed section. The purpose can be to measure the natural groundwater head or to measure how the groundwater head is affected by hydraulic disturbances such as pumping tests in the vicinity. Regardless of the purpose, it is usually best to use automatically recording equipment to measure groundwater head. Pressure transducers whose values are stored on a datalogger are usually used. The groundwater's pressure gradient constitutes the driving force for the groundwater flow, and this gradient is often small, requiring high accuracy in measurement. Sometimes it is necessary to take into account the density of the water, which is determined above all by its salinity.

SKB has developed three different logger systems specially intended for groundwater pressure head measurements. One is specially intended for long-term recordings of a head, and the software is designed so that only changes are stored in the memory. Another is specially intended for the previously described telescopic holes, where up to 10 heads can be measured. In both cases, the logger is placed in the borehole, enabling temperature to be kept constant to minimize errors caused by the temperature-dependence of the electronic circuitry. A third logger is particularly suitable where pressure transducers in several boreholes are connected to a common datalogger. In all cases, accuracy is better than  $1 \text{ cm H}_2\text{O}$ . Automatic measurement permits such frequent measurement intervals that, for example, daily fluctuations in the groundwater reservoir can be detected, such as tidal effects caused by the sun and the moon.

Sometimes it is necessary to seal off different hydraulic units in cored holes with packers without performing continuous pressure measurements. For an ordinary cored hole, without a telescopic section, a special device has been developed that permits pressure measurements in all sealed-off sections. It consists of a manually operated borehole valve, to which a pressure transducer can be docked for measuring one section at a time. Water samples can also be taken in this manner.

### Groundwater Flow

A method has been developed for determining the natural flow of the groundwater whereby a tracer dye is added to a sealed-off borehole section. As the groundwater flows through the measurement section, the dye is diluted. This dilution is constantly recorded by means of a transmission meter, which is the most important component of the complete dilution probe, which also performs tracer dosage and water mixing in the measurement section. The method can be used in measurement sections where the hydraulic conductivity is about 10-10 m/s or more /8-14/. However, the measurement limit is also dependent on the hydraulic

gradient as well as on borehole diameter and section length. Low water flux results in a long measuring time.

In the Hard Rock Laboratory Project, all boreholes are equipped with packers and the dilution probe cannot be used. Another method for dilution measurements will therefore be used. Twin hoses are run up from several of the sealed-off sections to the ground surface so that the water in the section can circulate. By adding a dye tracer and analyzing its dilution in connection with sampling, it is possible to determine the natural flow of the water. However, this method is not capable of measuring as low exchange rates as the dilution probe.

### 8.2.2.5 Hydrochemical Measurements in Boreholes

#### Water Sampling and Analysis

Water sampling and analysis of the chemical content of the water can be performed at different times during a drilling programme /8-15, 16/. Different types of sampling procedures are suitable for different purposes and yield results with different accuracies.

Sampling can be done during hydraulic air lift pumping/recovery measurements in connection with both percussion and core drilling. These samples have the advantage that they provide information on the chemical composition of the water at an early stage, but from the quality viewpoint the samples are contaminated with oxygen and often contain a high proportion of drilling water. Other opportunities for water sampling are in connection with pumping tests.

Special chemical sampling is done with the mobile field laboratory developed by SKB /8-5/. Sampling is done by lowering a sampling pump together with packer seals down into a borehole. The water pumped up from the sealed-off section is conducted through an in-situ measuring cell equipped with electrodes for measurement of Eh and pH. Up on the surface, the water passes through a second measuring cell where oxygen content and electrical conductivity are also measured. The measurement equipment includes a chemistry laboratory where most relevant substances are analyzed. This direct analysis on the sampling site in combination with recording of pH, Eh and sometimes also sulphide content down in the hole results in high quality, especially in the determination of the water's redox conditions and content of redox-sensitive substances.

Any gases dissolved in the groundwater are normally lost to a large extent due to the pressure reduction when the water is pumped to the surface. In order to circumvent this, a special sampling cylinder has been developed. It is placed down in the borehole next to the pump, and after a period of pumping it fills with water and is sealed. The sampling cylinder is then lifted up and taken to the gas laboratory for quantitative analysis of the gases that have evaporated from the water.

The sampling pump used for the mobile field laboratory has a low capacity, about 120 ml/s. It is hydraulically driven and therefore requires a great deal of peripheral equipment. It should be possible today to develop a simpler pump system with greater pumping capacity.

#### Tracer Tests

Tracer tests can be used for geometric characterization of water-bearing fractures and fracture zones and to determine the transport properties of these structures. The measuring method entails dosing out a tracer at one or more points (boreholes or borehole sections) and sampling and analyzing the amount of tracer transported to one or more other points. The tests can be carried out with the natural gradient as the only driving force, but usually the sampling hole is pumped out, and sometimes the tracers are injected under pressure in the dosage hole.

A simple type of tracer test is performed in connection with drilling by adding tracer to the drilling water. If pumping takes place in an adjacent hole, any breakthrough of tracer can be recorded /8-17/. This can be a suitable preliminary method in, for example, a targeted study of individual fracture zones, and has been used in SKB's fracture zone tests at Finnsjön. Moreover, the addition of tracer to the drilling water is valuable for judging the quality of subsequent water samples.

The methodology for special tracer tests has been developed and tested at Stripa /8-18/ and Finnsjön.

### 8.2.2.6 Rock Stress Measurements

There are two fundamentally different methods for determining rock stresses in boreholes: overcoring and hydrofracturing. Both methods have undergone considerable development in recent years.

Overcoring is done as follows: During drilling of a hole, an interruption is made for measurement. A smaller pilot hole is drilled in which strain gauges are installed. Then a sample cylinder is drilled around the pilot hole containing the strain gauges. In this way, it is possible to determine the stresses in the rock in three dimensions. The most recent development is that a borehole logger continuously records the readings of the gauges while overcoring is in progress.

Hydrofracturing is done as follows: A new fracture is induced in the rock around an existing borehole by hydraulic overpressure between packer seals. The water pressure that is required to keep the fracture open and the direction of the fracture are then measured, see Figure 8-3. The equipment resembles the hydraulic injection equipment in the umbilical hose system described previously, but higher pressures are required /8-19/. The direction of the fractures is determined with an impression packer and a borehole camera with inclinometer and compass.

### 8.2.2.7 Position Determinations in Boreholes

For every measuring method used, the position of the measuring point or section must be determined. Normally, only the depth along the borehole is measured. Where higher demands are made on accuracy, the slope of the borehole and how it deviates from a straight line along its length must also be measured. Such deviation measurement is carried out in connection with geophysical logging, usually with a borehole probe contain-

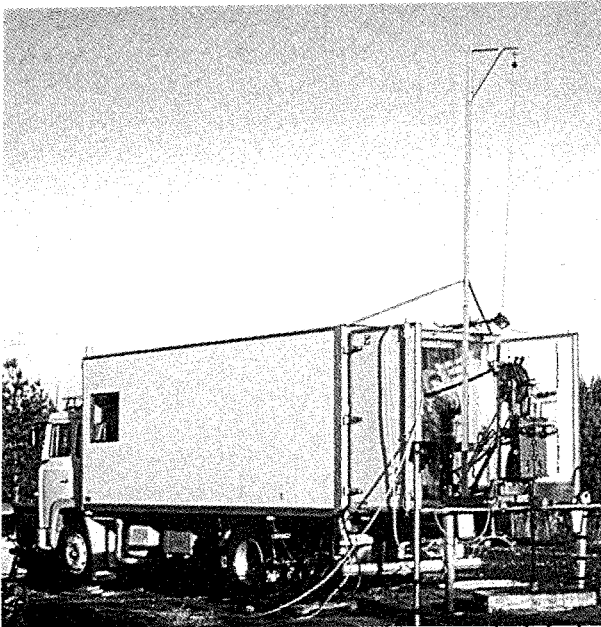

ing a compass and an inclinometer. Another method is based on recording the bending of a pilot tube as it is inserted down along the hole. The accuracy in the measurement of the deflection of the borehole is about 1 m in a 1000 m long hole.

Good accuracy in these measurements is extra important when different measurement results are to be compared with each other, especially in statistical correlation studies. Measurements with high demands on position determination include various kinds of cross-hole measurements. Detailed pre-investigations prior to underground construction also require good three-dimensional position determination. The different measuring probes are lowered on different types of carriers: pipe strings, logging cables, multihoses etc. Even at accuracies of 0.5%, the uncertainty is 5 m over a depth of 1000 m. Limited preliminary studies have been made of a technique for marking the boreholes at set depths in order to be able to calibrate the depth measurement later with every measuring method used.

### 8.2.3 Measuring Methods and Instruments for Investigations from Tunnels and Shafts

Many of the measuring methods and instruments described under sections 8.2.1 and 8.2.2 can also be used in investigations in tunnels and shafts or in holes drilled from such underground structures. SKB will be carry-

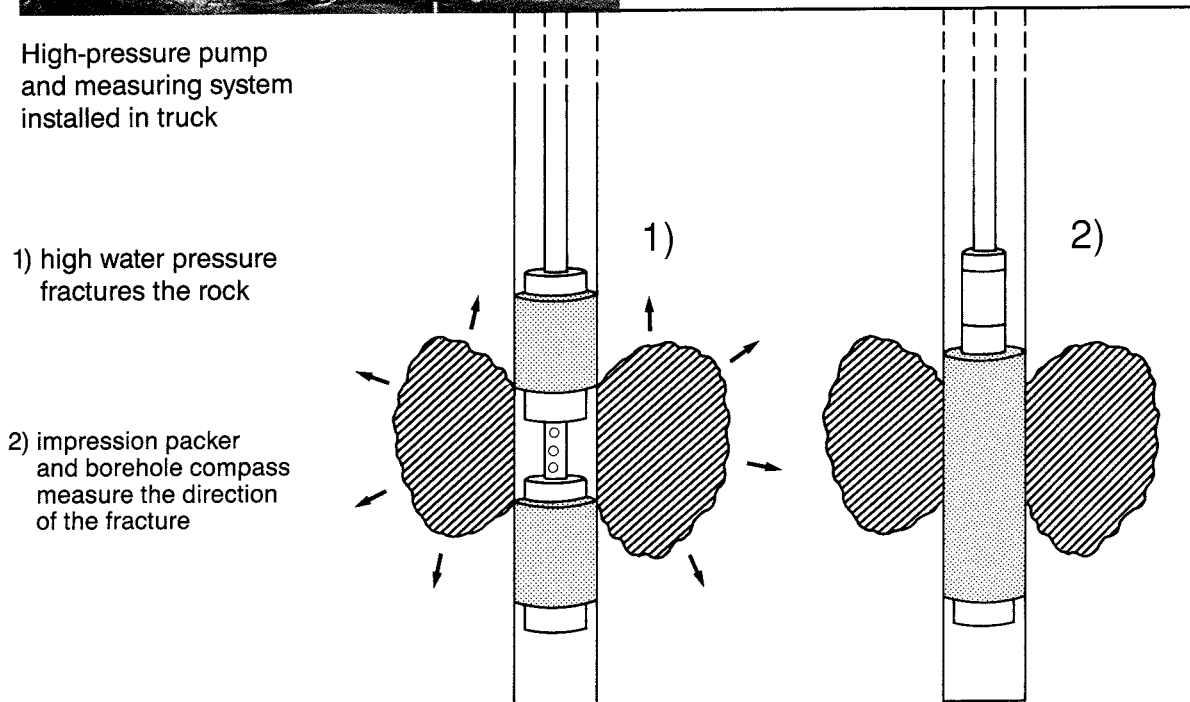

Figure 8-3. Mobile equipment for rock stress measurements by means of hydrofracturing. The equipment can be used down to a depth of 1000 m in 56 mm or larger boreholes.

ing out such investigations primarily in connection with the detailed site investigations. Investigations from tunnels permit more close-up studies of larger underground rock surfaces than boreholes from the ground surface. At the same time, the usefulness of such rock surfaces in a larger rock volume is dependent on the three-dimensional extent of the tunnel system; shafts alone offer limited accessibility in this respect.

The following summary of the present-day state of knowledge within this area is limited to methods that are particularly appropriate for investigations from underground structures. The knowledge is based in part on experience from Swedish rock construction and more directly on the projects which SKB has run or participated in: CLAB, SFR, Stripa and Hylte.

### **Geological Mapping**

Geological mapping of underground facilities can be done with different levels of ambition, depending on the purpose of the mapping. For detailed documentation, it is of the utmost importance that mapping be done as soon as possible after each round of blasting; this is particularly true of the tunnel face, which will be blasted away by the next round. Mapping at the tunnel face requires careful coordination with the tunnelling work. Limited method studies have been conducted in connection with the excavation of a power plant tunnel at Hylte.

### **Prediction of Water-bearing Fracture Zones**

In connection with tunnelling, it is of urgent importance for several reasons to be able to predict water seepage into the tunnel. Depending on the degree of detail in the pre-investigations, an idea has already been obtained from them of presumptive flow zones. Pilot holes can be drilled from the tunnel face to obtain direct information on the conditions in the area immediately adjacent to the face. Predictions can also be made on the basis of indirect geophysical measurements or a gradually increasing body of knowledge on the rock volume in question. Examples of indirect geophysical methods that should be applicable are radar and seismic surveys, which are deemed to have considerable potential.

### **Geohydrological Investigations**

Geohydrological investigations are in many cases simpler to perform underground since it is possible by means of passive measures to cause hydraulic disturbances whose response can be measured and evaluated. The tunnel system is in itself a hydraulic disturbance whose effects can, however, be difficult to control, especially if the structure has a complex geometric layout. But if it is possible to monitor the process by careful recording of parameters such as water pressure, underground construction offers a unique opportunity for geohydrological characterization.

The mapping of water seepage in the tunnel wall has previously been mentioned as an important part of over-

all characterization. Different kinds of measurements can be performed in boreholes from a tunnel, of which flow measurements accompanied by pressure buildup measurements are the most common. All boreholes, including pilot boreholes if they have not been blasted away, should be sealed with packers so that the enclosed water head can be measured /8-20/. This makes simpler types of cross-hole measurements possible. Careful documentation of all ongoing activities that might disturb the hydrological picture also provides good opportunities for performing a detailed hydrogeological characterization of the rock volume. For special studies, such as different types of cross-hole measurements, more advanced methods and instruments have been developed, for example within the Stripa Project /8-21/.

Measurements of water seeping into the tunnel can be performed by constructing measuring dykes across the floor of the tunnel at suitable intervals. The seepage inflow within each tunnel section is measured at a measuring weir at each measuring dyke. It is important that these dykes provide a tight seal down through the tunnel floor, which has been loosened by the blasting procedure. Otherwise, some of the water will pass underneath the dykes.

For more accurate measurement of seepage through tunnel walls and roofs, the latter can be sectioned and lined with plastic sheets, which has been tried in the Stripa Project. At low seepages, the ventilation air carries off a large portion of the water. This can be checked by completely screening off a tunnel section and measuring the humidity of the entering and leaving ventilation air (ventilation test).

### **Hydrochemical Investigations**

Just as it is important to keep track of how the groundwater head is distributed and changes during underground work, it is also important to keep track of the chemistry of the groundwater. Sampling from packer installed boreholes underground is very easy to do and is used both for hydrochemical analysis and tracer tests. In tracer tests, both natural tracers such as salinity and redox conditions and artificially added tracers can be used.

### **Rock Mechanics Investigations**

Rock mechanics parameters must be taken into account in connection with underground construction work. A large number of methods and instruments are available for measurement and recording of rock stresses and deformations. Of particular interest are methods where the influence of the rock stresses on the geohydrological parameters is investigated. This can be done in large rock blocks that have been completely or partially isolated from the rock volume.

When conducting investigations in rock caverns, it is necessary to bear in mind the fact that the area immediately adjacent to the rock wall is heavily disturbed due to increased fracturing caused by the blasting as



well as altered conditions of stress. The special properties of this area, known as the skin zone, can be of great importance for the safety assessment and require further study.

### **8.3 RESEARCH PROGRAMME 1990 – 1995**

The activities that are planned within method and instrument development for the period 1990–1995 are associated either with SKB's Hard Rock Laboratory Project or with the coming detailed investigations. The development projects are presented under subject area headings, in the same way as above for "Present-day state of knowledge", even though method and instrument development, wherever possible, strives for the development of "multidisciplinary" methods and instruments. This permits both cost- and time-effective investigations.

Installations and systems for data collection in the Hard Rock Laboratory Project must be designed to meet high demands on accuracy, function and reliability, as well as on flexibility in terms of expandability, connection of alternative measuring transducers and varying measurement intensity.

Unless otherwise stated, the measuring methods and instruments described are planned for 56 mm boreholes and use in 1000 m long boreholes. The 56 mm diameter is usually a minimum diameter, which means that boreholes of larger diameter can also be used.

Measurements at depths greater than 1000 m can be performed in boreholes from tunnels, for example in the Hard Rock Laboratory. Development of the measurement technology for boreholes longer than 1000 m is judged to be complicated, but not impossible.

#### **8.3.1 Geological Measuring Methods and Instruments**

##### **Drilling**

Under the heading "Present-day state of knowledge", an alternative core drilling method was described that can be used to reduce the penetration of drill cuttings and drilling water into the rock formation. A limited preliminary study has been carried out for another method, core drilling with reverse flushing. The premises and difficulties of the method have been defined, and a drilling test with reverse flushing will be carried out in the next stage. In percussion drilling, and in particular in pilot or probe drilling in tunnels, such drilling parameters as drilling rate, drilling water pressure, drilling water flow etc are important in evaluating rock types, fracture systems and the like. Automatic recording of such parameters increases the degree of sensitivity in such data acquisition and will be tested. In core drilling as well, similar recording systems should greatly facilitate the documentation of such parameters.

##### **Tunnel Mapping**

Tunnel mapping will be carried out on a very large scale during the coming programme period in connection with the construction of the Hard Rock Laboratory. This mapping will be performed during brief and extended interruptions in the rock work, but also right up at the tunnel face after each blasting round. In order to ensure well-executed mapping under the difficult conditions that will exist, very good coordination with the rock work and the use of the right technical aids are required. Such technical aids include equipment and methods for simple coordinate measurement and photodocumentation. Computer aids for tunnel mapping will be developed, and the possibility of storing mapping results in CAD systems will be explored. Such a CAD system should be able to be used both as a tool in interpreting fracture zones and other structures and for the presentation of graphic volume drawings.

##### **Mapping of Drill Core and borehole**

A new borehole TV system is being developed that will make it possible to inspect 1000 m deep boreholes with a diameter of 56 mm. This system can be used for orientation of fractures but also for visual examinations of the borehole wall. The possibility of further development on the image processing side to simplify fracture orientation will thereafter be explored.

##### **Position Determinations in Boreholes**

Under the corresponding heading in Section 8.2.2.7, the problems involved in making absolute three-dimensional position determinations in boreholes were described. The pre-studied method, of placing markings in the boreholes at predetermined depths so that they can be detected later in connection with borehole measurements for the purpose of calibrating the depth measurement systems used in these methods, is being further explored.

#### **8.3.2 Geophysical Measuring Methods and Instruments Radar**

As far as borehole radar is concerned, the development of directional antennas is nearly concluded. This work, which has been pursued within the Stripa Project, has resulted in an antenna prototype with satisfactory function. SKB is currently conducting further work on making this type of antenna into a fieldworthy instrument for measurements in deep boreholes from surface. This means that accurate orientation sensors must be integrated in the borehole probe. Further progress is also required within processing and presentation technology.

The antennas are the most important component of the radar. The frequency can be changed to obtain different resolutions and ranges. Furthermore, the antennas are specially designed to provide optimum contact

with the bedrock. Thus, special antennas will be required for measurements directly in tunnels. Such tunnel antennas must be particularly insensitive to disturbance from different tunnel installations. Development of antennas intended for measurements directly from tunnels has recently been started. The radar system will be designed so that measurements from tunnels to boreholes and vice versa can also be done.

In connection with tunnel construction, the radar methodology should also be able to be used as a tool for predicting any zones in front of the tunnel face, with the aid of a tunnel radar version of the VSP method.

### **Seismic Methods**

Borehole seismics is a measuring method used by SKB within the international Stripa Project. The method should also be tested within other projects. Like radar, seismic surveys are suitable for use within the construction phase of the Hard Rock Laboratory Project.

## **8.3.3 Geohydrological Measuring Methods and Instruments**

### **Hydraulic Measurements**

The method tested within the Hard Rock Laboratory Project of carrying out flow meter logging in connection with pumping tests will be further refined, particularly with regard to the measuring resolution of the flow logger. Both active and passive hydraulic measurements will be performed on different scales within the Stripa Project. Special equipment for automatic execution of these measurements has been developed and will be tested. The channelling phenomenon, which determines how the water flow paths are subdivided in a fracture system, are studied within the Stripa Project. Special equipment will be designed to carry out detailed measurements along the fracture. Both single-hole and cross-hole measurements will be performed.

### **Groundwater Head**

Within the Hard Rock Laboratory Project, all boreholes will be provided with a multipacker system after the introductory borehole measurements have been completed. The purpose is to avoid short circuiting between different hydraulic units and to be able to measure heads and take water samples in the screened-off sections. The measuring system for this is specially adapted for the telescopic boreholes in the Hard Rock Laboratory Project. An equivalent measuring system has also been developed for 56 mm cored holes of the standard type. This system is designed so that someone living near the measuring site can be used to make the readings. This way of conducting long-term recordings will be tested in several boreholes at eg Finnsjön.

### **Groundwater Flow**

The dilution probe for measurement of the flow rate of the groundwater in a borehole section described in Section 8.2.2.4 can be used in boreholes with a diameter of 56 mm or more. Further development of this equipment (for use in 56 mm boreholes, among other things) has long been planned and will be carried out during the coming three-year period. Even if the other methodology that has been described, carrying out dilution measurements via a circulation system in the packer-sealed telescopic boreholes, have poorer resolution, it will be used relatively extensively in the Hard Rock Laboratory Project.

### **Measurements in Tunnels**

In connection with hydraulic measurements underground (from tunnels), a hydraulic disturbance is normally created by, for example, allowing water to flow out of a borehole. The pressure disturbance is measured via the system installed in the boreholes.

An underground facility in the form of tunnels and/or shafts, such as the Hard Rock Laboratory, will in itself constitute a large-scale disturbance of the natural groundwater reservoir. In order to assimilate all the information such a disturbance can provide, a measuring system for pressure and flow must be installed during the construction phase. Pressure head will mainly be measured in boreholes. The disturbance shall also have been preceded by a long period of recording of natural conditions, which is the case in the Hard Rock Laboratory Project. Pressure head measurements are sensitive to variations in water density, which is in turn dependent on salinity and temperature. The temperature of the bedrock has been regarded as constant in this case, while salinity can change due to the disturbances and water extraction caused by the facility and must therefore be kept under surveillance. Flow will be measured in boreholes. Water seepage into the facility will be monitored carefully, primarily through a system of measuring dykes and weirs. Heavy water seepage in tunnel walls and roofs will be measured separately. In order to obtain a total picture of the water seepage in certain sections, moisture transport with the ventilation air can also be measured. Suitable instruments will be developed for these measurements.

## **8.3.4 Chemical Measuring Methods and Instruments**

### **Water Sampling**

The routine of taking water samples in connection with other measurements wherever possible will be adapted to an effective level. The sampling pump used at the mobile field laboratory has a low pumping capacity and requires considerable peripheral equipment. A new sampling pump that has greater capacity and is simpler to

use will therefore be developed. A special water sampler is required for long-term sampling in the telescopic boreholes.

A number of new chemical investigations will be carried out within the Hard Rock Laboratory Project, requiring both modification of existing, and development of new, measuring methods and instruments. Among other things, equipment for recording of redox potential and other sensitive parameters will be installed permanently or connected temporarily to boreholes.

### **Tracer Tests**

Tracer tests will be carried out and further developed during the coming programme period, eg within the Hard Rock Laboratory Project. In the multipackered boreholes, it shall be possible to carry out dosings with the same equipment as that developed for dilution measurements.

During the construction phase of the Hard Rock Laboratory, the draining effect of the facility on the rock volume will be utilized as a large-scale tracer test. Through the routine water sampling and the installation of recording measuring cells for Eh, pH etc, natural tracers such as redox front and salt water front, as well as artificially added tracers, will be utilized. Special tracer tests in which sorbing tracers will also be used are planned around fracture zones and in the rock mass sur-

rounding such zones. The measuring technique will be further developed for this purpose.

A simple technique for qualitative determinations of tracer leakage into fractures or fracture zones passed by the tunnel is desirable. A preliminary study of this will be conducted before the start of the construction phase for the Hard Rock Laboratory. The goal is to use ultraviolet light to detect fluorescing tracers that penetrate into roofs and onto walls, and to try out documentation technique in the form of photographing and filming.

Different types of tracer tests will also be carried out within the Stripa Project. Predictions will be validated by means of tracer tests, both salt water injection with sampling and radar measurements, and tracer injection with sampling of all water flowing into the tunnel.

### **8.3.5 Rock Mechanics Measuring Methods and Instruments**

A rock mechanics investigation programme will be carried out during the construction of the Hard Rock Laboratory. Rock mechanics parameters such as stresses and deformations will be recorded. A measuring system for this purpose will be developed to meet the special requirements set up in the investigation programme.

## 9 HARD ROCK LABORATORY

### 9.1 BACKGROUND AND MOTIVES FOR CONSTRUCTION OF THE HARD ROCK LABORATORY

The scientific investigations within SKB's research programme are a part of the work of designing a final repository and identifying and investigating a suitable site. This requires extensive field studies regarding the interaction between different engineered barriers and host rock.

A balanced appraisal of the facts, requirements and evaluations presented in connection with the preparation of R&D-Programme 86 led to the proposal to construct an underground research laboratory. This proposal was presented in the aforementioned research programme and was very positively received by the reviewing bodies.

In the autumn of 1986, SKB initiated field work for the siting of an underground laboratory, the Hard Rock Laboratory, in the Simpevarp area in the municipality of Oskarshamn. At the end of 1988, SKB made a decision in principle to site the facility on southern Äspö about 2 km north of the Oskarshamn station. Construction is planned to start during 1990, provided that approval is obtained from the concerned authorities.

The most important reasons for pertinent the Hard Rock Laboratory are:

- verification of methods for surface and borehole investigations,
- testing of methods for detailed site investigations with shaft sinking or tunnelling,
- opportunity, in a realistic environment and on a large scale, to investigate conditions of importance for safety, eg groundwater flow and associated transport of solutes,
- opportunity, in a realistic environment, to carry out demonstration tests and long-term tests of the interaction between engineered barriers and rock,
- method development for rock construction works, waste handling and backfilling.

These motives are examined in greater detail in the following.

Investigations of conceivable final repository sites carried out thus far have only involved measurements on the ground surface and in boreholes. Investigations have also been carried out in and from tunnels at Stripa and in connection with certain construction work for other purposes. There is a need to directly verify the results of surface and borehole investigations with sys-

tematic observations from shafts and tunnels down to the depth of a future repository. The construction of the Hard Rock Laboratory provides excellent opportunities for such verification.

The detailed investigations of candidate sites that are planned for the latter half of the 1990s will include studies of the rock from shafts and tunnels at repository level. These detailed site investigations include the field studies and analyses that are supposed to provide the final confirmation that a selected site is suitable for the final disposal of long-lived and high-level radioactive waste. These studies are also supposed to provide sufficient data for adapting the repository to the selected site and for an assessment of the long-term safety of the adapted repository. This assessment shall be included in a siting application and shall show that the site fulfils the requirements in the Act on Nuclear Activities. Some of the technology and methods for carrying out such investigations have been developed and tested at Stripa. However, since Stripa is an abandoned mine, it is not possible to test all aspects of the methods there.

Tests in a previously undisturbed area provide additional opportunities for developing and refining the methods before they can be used "for real". On the candidate sites, it is appropriate to carry out the equivalent of what is known in ordinary industrial development work as "destructive" testing. It is therefore important to have access to a Hard Rock Laboratory where such tests can be carried out.

The central, and at the same time the most complex problem in the assessment of the final repository's long-term safety is the flow of groundwater in the rock's fracture system and the associated transport of substances dissolved in the groundwater. Extensive efforts have been made and are being made to shed light on this problem.

The future research should above all be devoted to tie together and completing the picture that has been obtained from the previous investigations at different sites. An initial such tying-together attempt is being made within phase 3 of the Stripa Project, where a Site Characterization Validation Test (SCV) is being carried out in a rock volume on a 100 m scale. Prior to the siting of the final repository, a similar tying-together attempt will be carried out on a larger scale to obtain more experimental data for the long-term safety assessment. Such a large-scale test can be carried out at the Hard Rock Laboratory.

When a fundamental design for the final repository has been chosen in the mid-1990s, the different parts included in this system will have to be tested on a realistic scale. Of particular importance is testing and demonstrating the interaction between engineered barriers

and rock in as realistic environment as possible. This will primarily involve long-range tests and demonstration trials on a full-size or representative scale. "Destructive" testing may also be required. This is yet another motive for building the Hard Rock Laboratory.

Prior to the construction of the final repository, it is necessary to develop and verify the methods and the technology needed for constructing tunnels and storage galleries, for determining exactly where the waste is to be emplaced, for handling the waste underground, for depositing the waste at the intended position and for backfilling and sealing the different parts of the repository. All of these activities must be carried out with documented quality in order to satisfy the safety requirements. Many of these techniques can be developed and tested in the Hard Rock Laboratory. Access to such a laboratory will provide good opportunities for satisfying the quality requirements.

## 9.2 SITING AND LAYOUT OF THE HARD ROCK LABORATORY

In R&D-Programme 86, it was stated that the new Hard Rock Laboratory should preferably be located in a place where existing services and the kind of infrastructure needed for research work already existed. One of the nuclear power sites should be considered first, such as Simpevarp in the municipality of Oskarshamn.

Investigations in the Simpevarp area were begun in the autumn of 1986 and have since continued on a relatively large scale in 1987, 1988 and the spring of 1989. On the basis of the results obtained, SKB has made a decision in principle to locate the Hard Rock Laboratory on the southern part of the island of Äspö, see Figure 9-1. Äspö has been found to be a suitable site for the Hard Rock Laboratory primarily for the following reasons:

- It meets the requirement on undisturbed conditions in the bedrock and the groundwater. Locating the Hard Rock Laboratory in an area exempted from industrial establishment should ensure that other activities will not disturb the research during the time required for certain long-term experiments.
- Äspö provides access, within a geographically limited area, to the different geological and hydrological conditions required for planned tests and their evaluation. The results of investigations of the bedrock on Äspö show a suitable variation between volumes of sound rock and fracture zones of varying character. The composition of the groundwater is representative of Swedish coastal rock and provides an opportunity for studies of prevailing conditions and changes in these conditions resulting from the construction work.
- The nearness to the facilities at the Oskarshamn nuclear power station on the Simpevarp peninsula

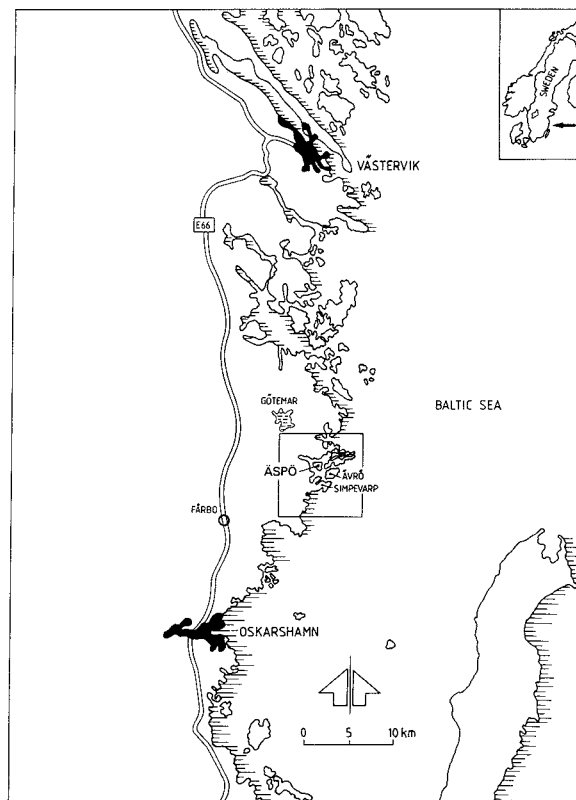

Figure 9-1. Äspö with environs.

minimizes the need for surface buildings. Service facilities and personnel that can be utilized for the activities are available nearby. The various facilities at the Oskarshamn nuclear power station are also suitable for, for example, stationing of researchers, meetings etc. The fact that OKG owns the land in question facilitates the leasing of the necessary land.

This siting presumes the approval of the concerned authorities, which is expected to be obtained during 1990.

The exact site of the Hard Rock Laboratory will not be considered as a site for the final repository. However, if appropriate geological conditions are found to exist in the vicinity, this could be one of the candidate sites that is subjected to detailed investigation prior to the final siting of the final repository.

Studies of alternative layouts of the underground portion of the Hard Rock Laboratory were performed during 1987. A tunnel ramp was found to be preferable to the sinking of a shaft to a depth of about 500 m. The tunnel alternative was chosen primarily because it provides better flexibility and a greater opportunity for collection of data and characterization of the rock mass. In August 1989, the Government decided that the Hard Rock Laboratory should be reviewed under the Act on the Conservation of Natural Resources. In connection therewith, SKB has decided to make a slight modifica-

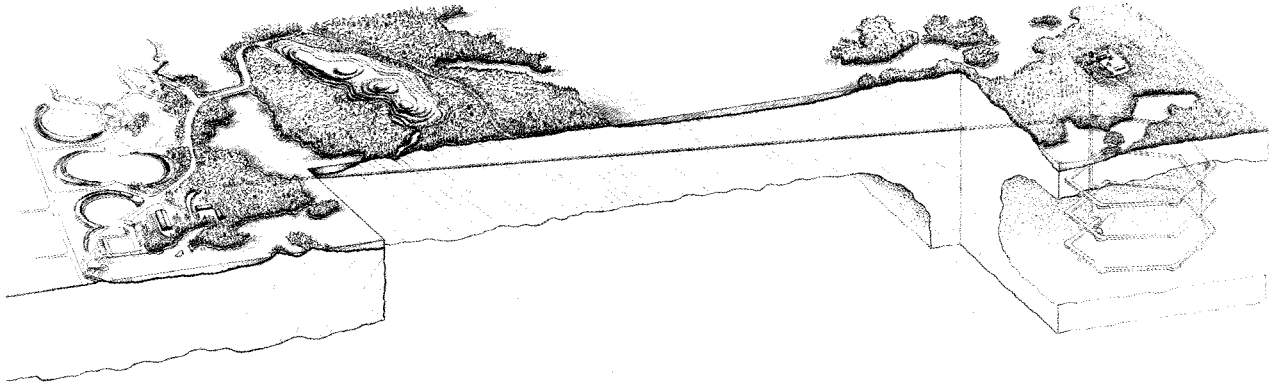

Figure 9-2. Preliminary design of the Hard Rock Laboratory.

tion of the layout of the laboratory that reduces its environmental impact. The new layout is shown in Figure 9-2, where the tunnel entrance is located on the Simpevarp peninsula instead of on the island of Äspö as previously planned. This entrance tunnel will also provide opportunities to study the zones indicated between Simpevarp and Äspö.

### 9.3 GOAL AND TIMETABLE

On the basis of the motives presented in Section 9.1, SKB has decided to construct the Hard Rock Laboratory for the purpose of providing an opportunity for research and development in a realistic and undisturbed rock environment down to the depth planned for the future final repository.

The Hard Rock Laboratory shall constitute an important complement to the other work being conducted within SKB's research programme.

Demands on the quality of the research are high and the overall ambition is that the laboratory should become an internationally leading centre of research and development regarding the construction of final repositories for high-level waste.

The main goals of the R&D work in the Hard Rock Laboratory are:

- To test the quality and appropriateness of different methods for characterizing the bedrock with respect to conditions of importance for a final repository,
- To refine and demonstrate methods for how to adapt a final repository to the local properties of the rock in connection with planning and construction,
- To collect material and data of importance for the safety of the final repository and for confidence in the quality of the safety assessments.

The last goal is general for SKB's entire research programme.

To meet the overall timetable for SKB's research work, the following stage goals have been set up for the activities at the Hard Rock Laboratory.

Prior to the siting of the final repository for spent fuel in the mid-1990s, the activities at the Hard Rock Laboratory shall serve to:

#### 1 Verify pre-investigation methods

- demonstrate that investigations on the ground surface and in boreholes provide sufficient data on essential safety-related properties of the rock at repository level, and

#### 2 Finalize detailed investigation methodology

- refine and verify the methods and the technology needed for characterization of the rock in the detailed site investigations.

As a basis for a good optimization of the final repository system and for a safety assessment as a basis for the siting application, which is planned to be submitted a couple of years after 2000, it is necessary to:

#### 3 Test models for groundwater flow and transport of solutes

- refine and test on a large scale at repository depth methods and models for determination of groundwater flow and transport of solutes in rock.

In preparation for the construction of the final repository, which is planned to begin in 2010, the following shall be done at planned repository depth and under representative conditions:

#### 4 Demonstrate construction and handling methods

- provide access to rock where methods and technology can be refined and tested so that high quality can be guaranteed in the construc-

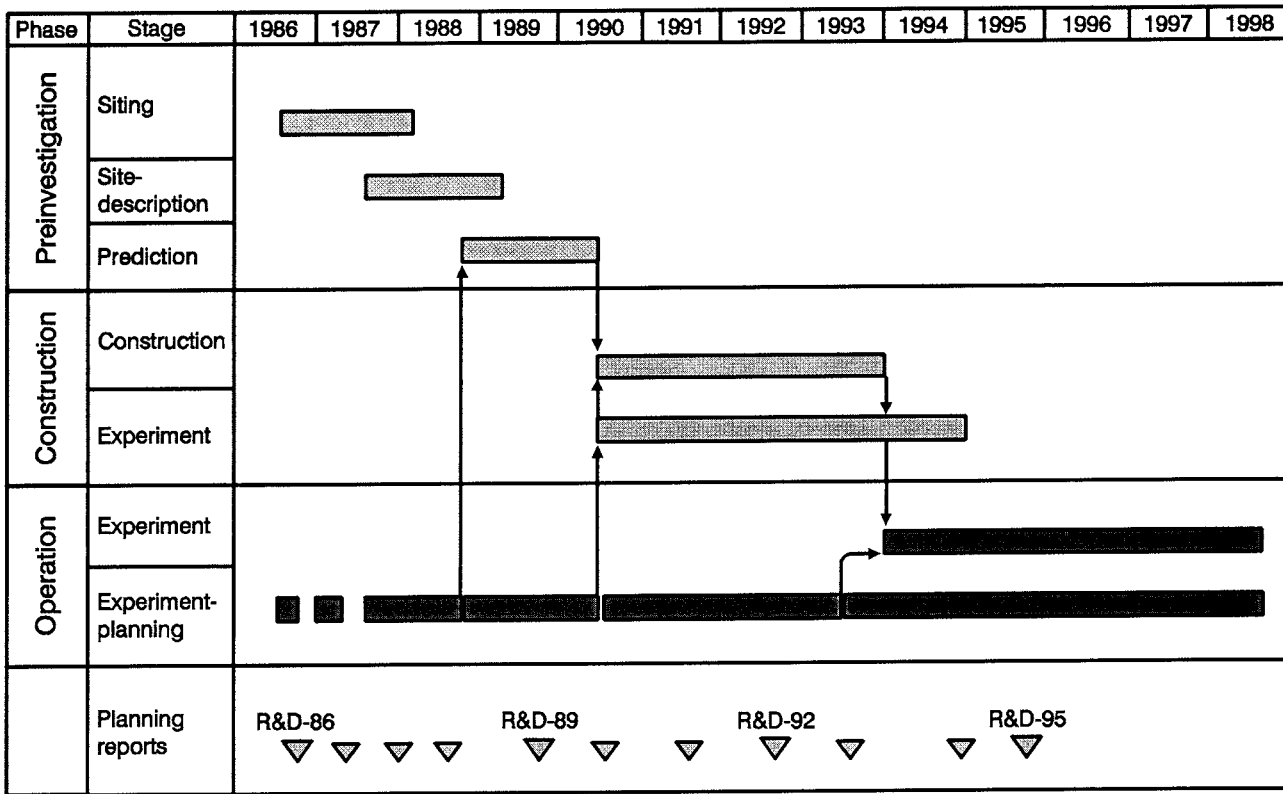

Figure 9-3. Hard Rock Laboratory. Overall timetable.

tion, design and operation of the final repository, and

5 Test important parts of the repository system

- on a full scale, test, investigate and demonstrate different components that are of importance for the long-term safety of a final repository system.

These tests shall be able to be carried out on a sufficient scope as regards time and scale to provide the necessary support material for Government approval of the start of construction. Certain tests may therefore have to be started in the mid-90s.

The properties of the rock that are of importance in different phases will vary. The testing of the quality of methods for rock characterization that is done at the Hard Rock Laboratory will be coupled at an early stage to the ability to determine the flow and chemistry of the groundwater at repository depth on the basis of pre-investigations. As the decision-making process progresses and as the prediction models and the safety assessments become more detailed, specific requirements will be made on the detailed information.

The work with the Hard Rock Laboratory is divided into three phases: the pre-investigation, the construc-

tion and the operating phase, see the timetable in Figure 9-3.

In the pre-investigation phase, a site will be chosen for the laboratory. The natural conditions in the bedrock will be described. In parallel with the preliminary investigations, the project's construction and operating phases will be planned.

During the construction phase, 1990-1994, a number of investigations and tests will be conducted in parallel with the construction activities. The tunnel will be excavated down to the 500 m level in stages.

The operating phase will commence in 1994. The thrust of the investigations and tests to be carried out during the operating phase is described in this programme. The final programme for the operating phase will be adjusted on the basis of the results of other projects and experience gained in the construction phase.

### 9.4 INVESTIGATIONS PERFORMED IN THE PRE-INVESTIGATION PHASE

Investigations of the bedrock will be undertaken both from the ground surface and in boreholes. Data will be

compiled in conceptual models as a basis for siting of the laboratory, layout of the facility and numerical calculations of groundwater flow on different scales.

The pre-investigation phase is divided into the following stages:

- siting,
- site description and
- prediction,

of which the first two have been completed and the results reported.

The investigations were begun in the autumn of 1986 and studies have been carried out on several different scales, both regional and local. The work was focussed almost from the start on a siting near the Simpevarp area, which has a good infrastructure for the planned activities.

The completed investigations have shown that favourable conditions exist on the island of Äspö north of Simpevarp for constructing the Hard Rock Laboratory, of which the following can be mentioned:

- A homogeneous rock block with few, well-defined groundwater-conducting structures exists on southern Äspö, where the access tunnel to the laboratory can be built.
- Nearby the above are a central shear zone and areas with very homogeneous Småland granite.
- Areas below the surface of the sea are available immediately adjacent to Äspö.

The results from the siting stage have been reported in /9-1/. The regional-scale rock description shows that the Simpevarp area consists primarily of granitic bedrock (Småland granite) with intrusions of basic rock types, greenstones. The information from the geological and geophysical surveys shows a tectonic picture of the Simpevarp area dominated by a nearly orthogonal system of first-order fracture zones in the N-S and E-W directions. Aside from this system, there are second-order zones running in the NW and NE directions that also form a nearly orthogonal system. There are probably also low-dipping, subhorizontal zones.

Of importance for numerical models of groundwater flow has been the fact that the Simpevarp area is surrounded by younger, granitic diapirs, which are also assumed to underlie the Simpevarp area at great depth. Regional well data show that these younger rock types are more permeable. The siting stage also included percussion drilling programmes on three sites to gather data for a chemical characterization of the superficial groundwater. It was judged that both Äspö and Laxemar were suitable sites for a Hard Rock Laboratory, see Figure 9-1.

The site description stage has been described in /9-2/. The continued investigations for siting were focussed primarily on Äspö. Laxemar will be used as a reference area where, for example, natural variations in groundwater levels can be followed and compared with the disturbed conditions that will exist on Äspö after the

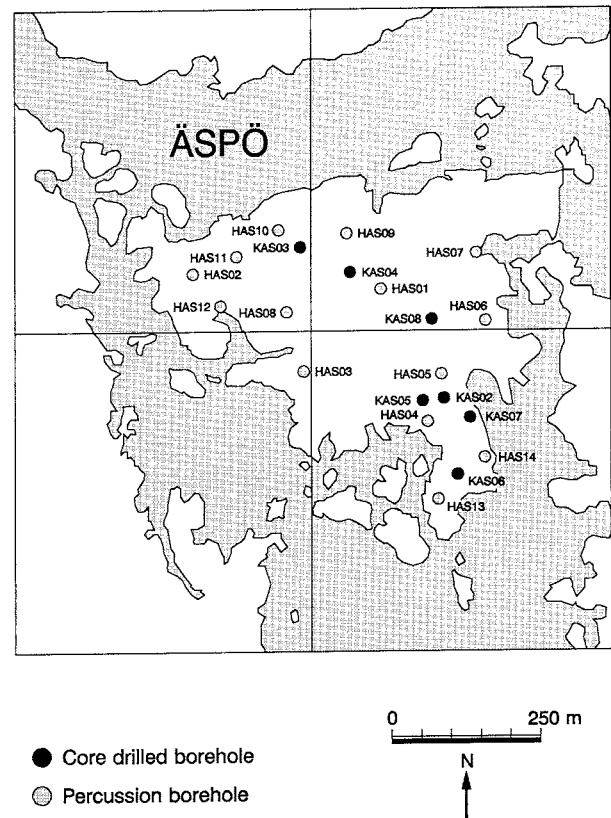

Figure 9-4. Location of boreholes on Äspö.

laboratory has been built. Four holes have been cored, the deepest down to a depth of 1 km. In addition to high-quality core mapping, extensive geophysical measurements have been carried out, along with hydro tests on several scales and hydrochemical analyses. Thorough surface investigations have been carried out on Äspö, including seismic profiles, outcrop mapping, geophysical measurements and cross-hole interference tests. In the cored holes drilled on southern Äspö, Småland granite is the dominant rock type down to a depth of more than 300 m. Below this, it is supplanted by a quartz-poorer version of the Småland granite called diorite. A large number of zones of different character exist on Äspö.

Southern Äspö has been proposed as the site for the Hard Rock Laboratory. Äspö offers conditions for scientific experiments of great interest for a safe final repository. Äspö also offers the conditions necessary for satisfactory execution of the qualified construction project. With a view towards future tests and experiments, it would be an advantage if different types of rock and zones could be studied in the Hard Rock Laboratory. This variation is available on Äspö with environs.



Hydrochemical conditions on Äspö are also representative of the conditions that would prevail in the event of a coastal siting of an underground facility. The groundwater is fresh near the surface and saline at greater depth. Several types of numerical calculations of groundwater flow have also been carried out in the site description stage.

The site description presented in /9-2/ has since been supplemented in the prediction stage with the drilling of an additional four cored holes, see Figure 9-4. These results and the associated numerical calculations will be described in a Technical Report in the spring of 1990. Predictions will be made on different scales, termed the regional scale, > 1000 m, the site scale 100–1000 m, the block scale, 10–100 m, and the detailed scale, 0–10 m. For each scale, the predictions to be made, the expected outcome, the grounds for validation and the measuring accuracy striven for will be defined. The predictions for each scale will be grouped according to research fields and will involve testing of conceptual models, groundwater flux, chemical environment, transport of solutes in groundwater and mechanical stability of the rock.

Calculations will be carried out on different scales and compared before the start of the construction phase with pressure and floor measurements in boreholes and with geohydrochemical data, especially the salinity of the water. The geological, geohydrological and groundwater chemistry predictions made during the prediction stage will be evaluated during the construction phase.

In order to check the conceptual model prepared in the site description phase, a long-range pumping test will be carried out during the summer of 1989. The measurement results will be used to evaluate the predictive calculations carried out before the long-term pumping. The results will also be used to prepare the final calculation model of the groundwater changes that will take place when the laboratory is built. A qualified radial tracer test will also be carried out before the construction phase begins. An evaluation of the long-term pumping will be presented in a Technical Report in 1990.

The new layout of the Hard Rock Laboratory that has been decided on (Sept. 1989), see Figure 9-2, affects the detailed planning of the conclusion of the pre-investigation phase.

## 9.5 PROGRAMME FOR THE CONSTRUCTION PHASE

During the construction phase, investigations will be carried out to validate expectation models reported during the pre-investigation phase. Furthermore, data will be collected for progressive improvement of previous predictions. The investigations will be carried out both along the surfaces of the access tunnel and in boreholes drilled from the ground surface and from the tunnel. Since favourable properties of the bedrock nearest

the deposition holes and deposition tunnels are of the greatest importance for the safety of a final repository, it is essential that the degree of detail in the investigations during the construction phase be gradually increased.

The investigations carried out during construction of the access tunnel will therefore be divided into stages.

The main level of the laboratory will be situated about 500 m below the ground surface. If later investigations within the framework of the general research programme should show that the final repositories should be situated deeper than about 500 m, a further extension of the tunnel to greater depth may be considered.

The work during the construction phase will largely be focussed on geological, geohydrological and groundwater chemistry aspects.

### 9.5.1 Geological Investigations

As far as geology is concerned, there are a number of both geological and geophysical methods available to assist in describing the composition and structure of the rock mass. The relevance of the different methods, both generally and in the local geological environment, is very incompletely documented, however. This is particularly true of conditions at great depth in crystalline bedrock. The overall goals of the geological documentation during the construction phase can therefore be summarized as follows:

- evaluate to what extent the pre-investigation methodology has provided an accurate description of the spacial distribution of rock types, large and small fracture zones and the fracture geometry and minerals of the rock mass in different geological environments and at different depths,
- establish the relevance of different investigation methods as regards rock types, structures, stability and hydraulic conductivity with respect to geological environment and depth,
- prepare a good prediction of the geological environment that will be encountered during the second construction stage and during the excavation of the 500 m level.
- develop and test methodology for detailed geological investigations on candidate sites for a final repository.

The geological expectation models will be devised primarily with respect to lithology and structures. Predictions will be made on different block scales for different geological environments. An effort will be made to define different lithological units and to describe the structure of the rock mass with regard to orientation and character.

Geological documentation of tunnels, shafts and boreholes will be done continuously in connection with the construction of the facility. The outcome will be compared with the expectation models prepared on the basis of results from the pre-investigations.

## 9.5.2 Geohydrological Investigations

As far as geohydrology is concerned, only a few qualified tests have been carried out to test the accuracy of models for groundwater movements in large rock volumes. The overall goals of the geohydrological investigations during the construction phase can be summarized as follows:

- evaluate to what extent the pre-investigation methodology used has provided an accurate description of the natural groundwater situation in different geological environments and at different depths,
- document the geohydrological conditions in the rock volume from tunnels and rock caverns on different scales and make geohydrological operating predictions for the blasting work,
- iteratively with the documentation, validate the different-scale models of the influence of the Hard Rock Laboratory on the steady-state geohydrological logical conditions,
- with the new data continuously being gathered during the construction phase, progressively refine and improve the predictions of geohydrological conditions at deeper levels,
- validate the updated expectation models of geohydrological conditions at deeper levels, including the 500 m level,
- develop methods for detailed geohydrological investigations on candidate sites.

In order to achieve these goals, it is necessary, as during the pre-investigation phase, that investigations be carried out in the field, that the data obtained be analyzed and processed integrally with the geological and geochemical investigations, and that the results be integrated into qualitative and quantitative models. The investigations are of crucial importance for the description of the rock in both the far field and the near field.

Records will be kept during the construction work of rock types, fracture content, reinforcing work etc. These records will also include data on water seepage in terms of quantity and location. Water seepage into the tunnel will be measured by means of measuring dykes and weirs along the access tunnel. The measuring dykes will be designed in such a manner that seepage water from the tunnel sections between two dykes can be measured and sampled.

An action programme describing how the geohydrological observations are to be carried out in connection with injection grouting and extensive reinforcing work will be drawn up. The programme will also define the limits for when injection grouting is to be carried out. It will also include guidelines for when side tunnels are to be arranged.

To investigate, describe and model conductive zones without disturbing and being disturbed by the construction process, it is planned that side tunnels will be driven out from the access tunnel. A side tunnel will be blasted

out if rock requiring extensive sealing and reinforcing work is encountered.

Probe holes will be percussion-drilled from the sides of the tunnel at the face. Pressure buildup tests and, if required, packer tests will be carried out in the holes, which will be drilled diagonally forward. These pilot investigations will be used to provide operating forecasts in combination with data from the tunnel and to supplement the database with geohydrological data collected underground. The boreholes will also be used for water sampling.

In addition to the probe holes that are drilled regularly at the tunnel face, the observation network under-work will be supplemented to characterize and measure the pressure in conductive zones. For this purpose, percussion boreholes are planned to be drilled with multi-packer systems along the tunnel run.

## 9.5.3 Geochemical Investigations

Investigations aimed at clarifying geochemical conditions in the bedrock will be carried out during the pre-investigation phase. This work will be carried out in stages that alternate between measurement, evaluation and prediction, where the collected results are used to predict the conditions and the changes expected during the construction phase. Since the groundwater is mobile, a drainage of shafts and tunnels will bring about a high groundwater flux. Accordingly, the changes that take place in water composition will reflect the geohydrological conditions. The goal of the geochemical investigations during the construction phase is to study changes in water composition and relate them to predictions made during the pre-investigation phase. The goals of the geochemical investigations during the construction phase therefore include the following:

- follow changes in the interface between saline and fresh water,
- study the transports of solutes in a large volume of rock,
- obtain material for validation of groundwater flow and transport models on a realistic scale,
- follow changes in the redox conditions in the groundwater,
- follow changes in the chemical condition of fracture minerals and determine the redox kinetics of the groundwater-fracture-mineral system,
- develop and test methodologies for detailed geochemical investigations on candidate sites.

The work includes studies of changes in the chemical composition of the water (natural tracers) as well as non-interacting tracers injected in surrounding boreholes and in boreholes drilled from tunnels as well as through seepage into the facility. The natural tracers should be able to describe the flowpaths of the water in

the uppermost stratum of the rock, while the injected tracers shall describe the flowpaths in the deeper-lying rock.

The fresh-water cushion on Äspö will be used to study the flowpaths in the near-surface rock (about 100 m). Owing to pressure head drawdowns in the tunnel, fresh water will run down and reach the tunnel in those points where the connection upward is good. In order to study the flowpaths in the deep rock, tracers will be injected in conductive zones via the cored holes previously drilled from the surface.

Sampling of groundwater will take place in probe holes and drainage ditches as well as with special holes in major flowpaths. The purpose of the sampling in the boreholes is to clarify changes in the chemical composition of the water. In addition, any drilling residues from drilling of the deep cored holes and any added tracers will be detected.

## 9.6 PRELIMINARY PROGRAMME FOR THE OPERATING PHASE

After the construction phase, the operating phase will begin. The planning for the operating phase is concentrated on the following proposed tests:

- large-scale tracer tests,
- block-scale tracer tests,
- block-scale redox tests,
- methodology for repository construction,
- pilot tests, repository systems.

The large-scale tracer tests are aimed at characterizing transport in the far field. In order to study the site-specific flowpaths existing in the bedrock around the Hard Rock Laboratory, tracer tests will be carried out on different scales. A large-scale tracer test will be started in the steady-state phase before the start of construction and continue throughout the transient construction phase. The results of this test will serve as a basis for planning of large-scale tracer tests during the operating phase.

Block-scale tracer tests will be conducted on an intermediate scale, about 50 x 50 m. The situation in a final repository with canisters deposited in rock of low hydraulic conductivity and with a "respect distance" to the nearest major water-bearing zone will be simulated in the investigation. The results of this study will be evaluated and used to validate transport models on a block scale, ie over distances on the order of 10-100 m. The investigation will also demonstrate our ability to characterize and select volumes of sound rock for

deposition. Transport models will be used to test the possibility of predicting the migration of solutes in a selected volume of low-conductivity rock adjacent to a fracture zone.

Block-scale redox tests will be carried out to demonstrate that the redox capacity of the rock is sufficient in the flowpaths. Reducing conditions at repository depth are a necessary requirement for long canister life. The groundwater that has been sampled on different occasions and on different sites within the study-site investigations has always proved to be reducing. The kinetics of the redox reactions between the minerals in the bedrock and the groundwater require further study, however. During the construction phase, when oxidizing water will get down into the facility, there will be opportunities to study these reactions. The investigation of the effect of the oxygenated water will be carried out on a block scale (several tens of metres), enabling all relevant parameters to be checked and provide an opportunity for an assessment of the rate of the exchange reactions.

Methodology for repository construction is aimed at demonstrating how the construction of a repository is to be accomplished. In connection with the construction of a repository, it is necessary to carry out a number of investigations to obtain a final basis for the design and layout of the repository and sealing of the repository, and to obtain data for the final safety assessment of the completed repository. The execution of the investigations is dependent on the choice of system for the final repository.

Pilot tests – repository systems is a series of pilot and demonstration tests to be carried out after the main principles of repository design and systems have been finalized in the mid-90s. The goal of the tests is to validate the models and demonstrate the function of the systems by clarifying the interaction between the rock and the selected buffers under conditions prevailing in disposal facilities. A further purpose is to develop and test methods and strategies for their application.

## 9.7 FURTHER INFORMATION

This chapter provides only a summary of the research programme for the Hard Rock Laboratory. A much more exhaustive account is provided in a special background report to R&D-Programme 89 published simultaneously with it. The programme will be progressively refined and updated on the basis of the experience and results obtained during the construction phase. The programme for the operating phase described above is preliminary and will be refined in greater detail in connection with future three-year programmes.

# 10 THE STRIPA PROJECT

## 10.1 GOALS AND RESULTS OBTAINED THUS FAR

The international Stripa Project started with Phase 1, which was carried out during the period 1980–1985, followed by Phase 2, which was begun in 1983 and completed for the most part in 1986. Research within these two phases has primarily been conducted within the following four subject areas:

- Geohydrological investigations of the Stripa granite and migration tests with nuclides in simple and complex fracture systems.
- Chemical investigations of the groundwater in the Stripa granite.
- Technique for detecting and characterizing fracture systems in granite.
- Study of bentonite clay for use as backfill and sealing material in a fracture-filled bedrock.

Current work at Stripa falls within Phase 3, which started in the autumn of 1986 and will be concluded in 1991.

### 10.1.1 Brief Summary of Results from Phase 1

Phase 1 of the Stripa Project included the development of methods and technology for investigation of the rock on a repository site. It also included verifying previously obtained laboratory results via field tests.

The results of the geohydrological investigations and the water chemistry sampling resulted in a recommendation that hydrological investigations should be conducted at repository depth. It is further observed that detailed knowledge of the chemical composition of the water, and the causes of it, requires a coordinated effort employing a number of investigation techniques.

Greater knowledge was obtained of water flow and nuclide migration in individual fractures. This knowledge in turn led to greater confidence in previously made predictions as regards nuclide retardation. The tests further showed that diffusion of radioactive nuclides into the rock matrix and sorption on fracture faces are processes that actively influence the rate of nuclide migration.

As far as buffer material is concerned, the tests showed that we can now describe and understand the physical properties of the bentonite and that we can predict them for different layouts of the final repository. In this context, the water-absorbing and swelling properties of the bentonite play a major role. It was fur-

ther shown that we have the technology for preparing and applying the bentonite as a buffer material.

### 10.1.2 Brief Summary of Results from Phase 2

Phase 2 of the Stripa Project involved a further refinement of methods and technology for investigation of the rock on a final repository site.

A cross-hole measurement programme demonstrated that technology is now available that permits characterization of fracture zones in crystalline rock with a degree of certainty and detail that was previously not possible. Geophysical investigations showed that the flow of groundwater is concentrated to a few major fracture zones. These fracture zones are regarded for purposes of simplification as being plane with a varying hydraulic conductivity along the fracture plane.

Detailed investigations of water flow and tracer migration in fractures have provided a further increase in knowledge. The work at Stripa has shown that knowledge exists for collecting and analyzing data on the structure and hydraulic properties of the rock mass. In this way, as one step in the safety assessment, the conditions on a potential final repository site can be compared with conditions on another site.

Migration tests, together with tritium measurements, provided support for the theory that a portion of the water flow in fractures takes place in more or less well-defined channels which have little contact with each other. However, further research is necessary to develop numerical models that describe the water flow in a fractured rock mass.

The sealing and plugging tests at Stripa showed that the technology and material exist to redirect the water flows in a fractured rock mass away from blasted-out tunnels and shafts. Under repository-like conditions, highly compacted sodium bentonite proved to be a suitable material for plugging boreholes, drifts and shafts. After the bentonite has absorbed water from the surrounding rock and swelled, the hydraulic conductivity of these plugs is considerably lower than the conductivity of the surrounding rock mass. A particularly important property of the bentonite is its ability, together with the rock, to create integral tight plugs that effectively prevent water flow in the contact zone between rock and plug. The special physical properties of the bentonite are such that its sealing properties remain undiminished even if the rock mass is subjected to stress redistributions with accompanying rock deformations.

The results of Phases 1 and 2 have shown that significant advances have been made in the development

of methods and technology for detailed investigation of the rock on a potential repository site, as well as in the development of engineering methods for sealing of the rock mass. The results of the work done in Phases 1 and 2 are summarized in /10-1/ and /10-2/, respectively.

### 10.1.3 Goals of Phase 3

Phase 3 of the Stripa Project entails an application of results and a further refinement of technology from Phases 1 and 2. The orientation and goals of Phase 3 can be summarized in brief as being to:

- apply different types of pre-investigation techniques and methods for analysis of the results to predict and validate groundwater flow and nuclide transport within an undisturbed rock volume in the Stripa mine,
- test and demonstrate different types of material and technology for sealing water-bearing fractures in the Stripa granite.

Phase 3, which was begun in 1986 and will continue until the end of 1991, is thus aimed at applying pre-

viously gained experience to an undisturbed granitic rock volume in the Stripa mine. In Phase 3, the previously developed measuring technology is being coupled to a mathematical modelling effort so that theoretically calculated values can be compared with values measured in the field. Technology for field measurements is also being further refined. As far as engineering methods for sealing of the rock are concerned, the goal now is to find suitable methods for injection grouting and to determine the long-term properties of materials for sealing of fractures etc /10-3/.

## 10.2 PRESENT-DAY STATE OF PROJECT AND RESEARCH PROGRAMME 1990–1992

The results of the Stripa Project are reported regularly in the project's own report series and at periodical workshops. A Stripa symposium was held in 1989. Another Stripa symposium will probably be held after the end of the project in 1992. Results are reviewed continuously and the thrust of the continued work is dis-

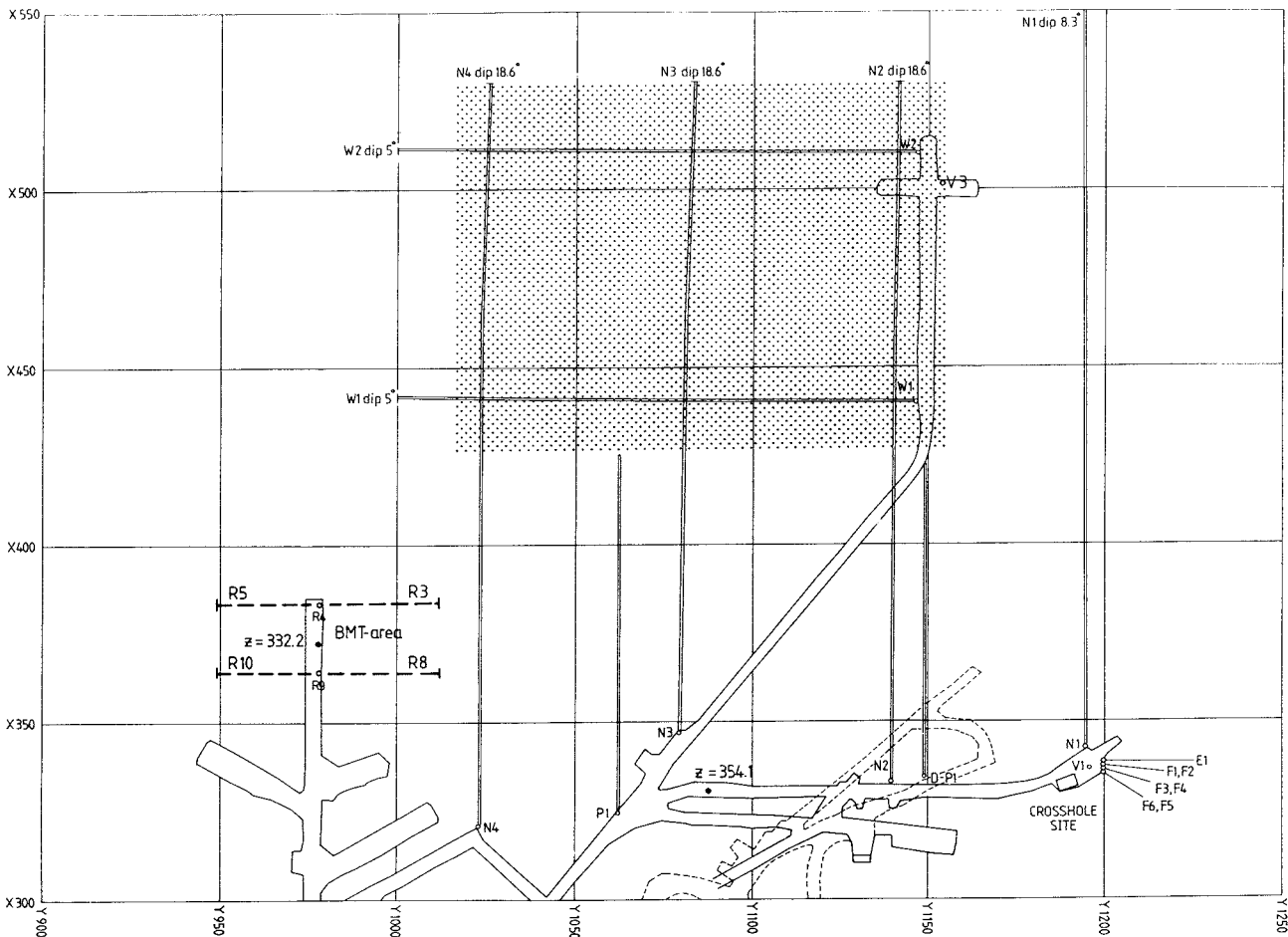

Figure 10-1. SCV area's extent and location in plane, plus location of N and W holes drilled during Stage 1 of the SCV programme.

cussed in a Technical Sub Group (TSG) composed of representatives from the project's member countries.

Research within Phase 3 is divided into the following three main areas:

- Site Characterization and Validation; through step-by-step investigations followed by a compilation and prediction phase, a limited rock volume and its properties are characterized and finally validated.
- Improvement of Site Assessment Concepts and Methods; continued development and refinement of the technology and the methods for investigation and characterization of rock that was begun during Phases 1 and 2.
- Sealing of Fractured Rock testing and evaluating the long-term stability of materials that can be used to seal fractures in the rock and development of technology for injecting these materials into the fractures in the rock.

### 10.2.1 “Site Characterization and Validation”

The SCV programme is divided into five substages:

**Stage 1. Introductory investigations.** The rock volume (the SCV area) measuring 125 x 125 x 50 metres at the 360-metre level in the Stripa mine that is included in the investigation programme has been investigated during Stage 1 through six boreholes, the so-called N and W holes. These boreholes have been situated so that the geological, hydrological, geophysical, hydrochemical and rock mechanics investigations performed in the boreholes provide as comprehensive a picture as possible of the properties of the rock mass, see Figure 10-1. In addition to the borehole investigations, adjacent drifts have been mapped with respect to the frequency, orientation and properties of the fractures. Furthermore, a system for measuring the water head in all the boreholes surrounding the SCV area has been installed. It is of great importance in the interpretation of the hydrological conditions within the SCV area that conditions at the boundaries of the area be known. The results of all investigations in Stage 1 have been reported in the Stripa Reports /10-4 – 10-15/. The 180-metre-long access drift that leads up to the border of the SCV area was also excavated during Stage 1. The terminus of this drift will be used in later stages of the programme as a starting point for further investigatory drillings as well as for the “validation drift”.

**Stage 2. First prediction.** Based on the material collected during Stage 1, a model has been devised describing the expected geological, hydrological and hydrochemical properties of the SCV area. Thus, a number of fracture zones that intersect the area have been identified. These zones have been verified by means of a number of different geophysical measuring

methods. The zones are not all necessarily water-bearing; only some of the defined zones have been identified as hydraulic zones. The model of the SCV area is complemented by the rock stress measurements carried out nearby. This prediction or expectation model of the area, based on the investigations in Stage 1, is documented in the Stripa Report /10-16/. The report not only describes the final conceptual model based on Stage 1, but also presents the line of reasoning that has led to the proposed model.

**Stage 3. Detailed investigation and validation of the prediction made in Stage 2.** Based on the expectation model produced in Stage 2, a new investigation programme is being carried out in Stage 3. The programme contains essentially the same types of investigations as were carried out in Stage 1, but with the important difference that three new boreholes, the C holes drilled in the SCV area during Stage 3, are located to provide information that can verify the model of the area compiled in Stage 2, see Figure 10-2. The measurements in these boreholes were completed during the first half of 1989. Stage 3 also includes drilling of the six D holes. The D holes are about 80 metres long and are drilled within a circle with a diameter of 2.5 metres. The intention is that the validation drift that will be excavated during Stage 5 of the SCV programme shall have a diameter that agrees with the circle that circumscribes the D holes. The D holes will also be utilized to verify the model from Stage 2 and to gather further information about the SCV area. Hydraulic cross-hole measurements, as well as measurement of the water flowing in from the surrounding rock, will also be carried out in the D holes. These inflow measurements in the D holes will be used not only in the SCV programme but also in the numerical modelling programme for calibrating and, for one of the models, for making a preliminary prediction of the water inflow to the validation drift, which will be excavated in Stage 5. The fracture zones that are of importance for water inflow to the D holes will be characterized by means of radar measurements after salt injection in the water-bearing zones.

**Stage 4. Detailed prediction.** Based on the material collected during Stage 3, the model describing the expected geological, hydrological and hydrochemical properties of the SCV area that was developed in Stage 2 is now being updated. This work is being completed during the latter part of 1989.

**Stage 5. Final evaluation.** The model of the SCV area developed in Stage 4 will be evaluated by the excavation of a validation drift with a length of about 75 metres in the SCV area, see also Figure 10-2. This drift is expected to intersect one or more of the fracture zones that have been identified by means of the different borehole measurements. In addition to water inflow and its distribution, fracture distribution and the physical properties of the fracture zones identified by means of

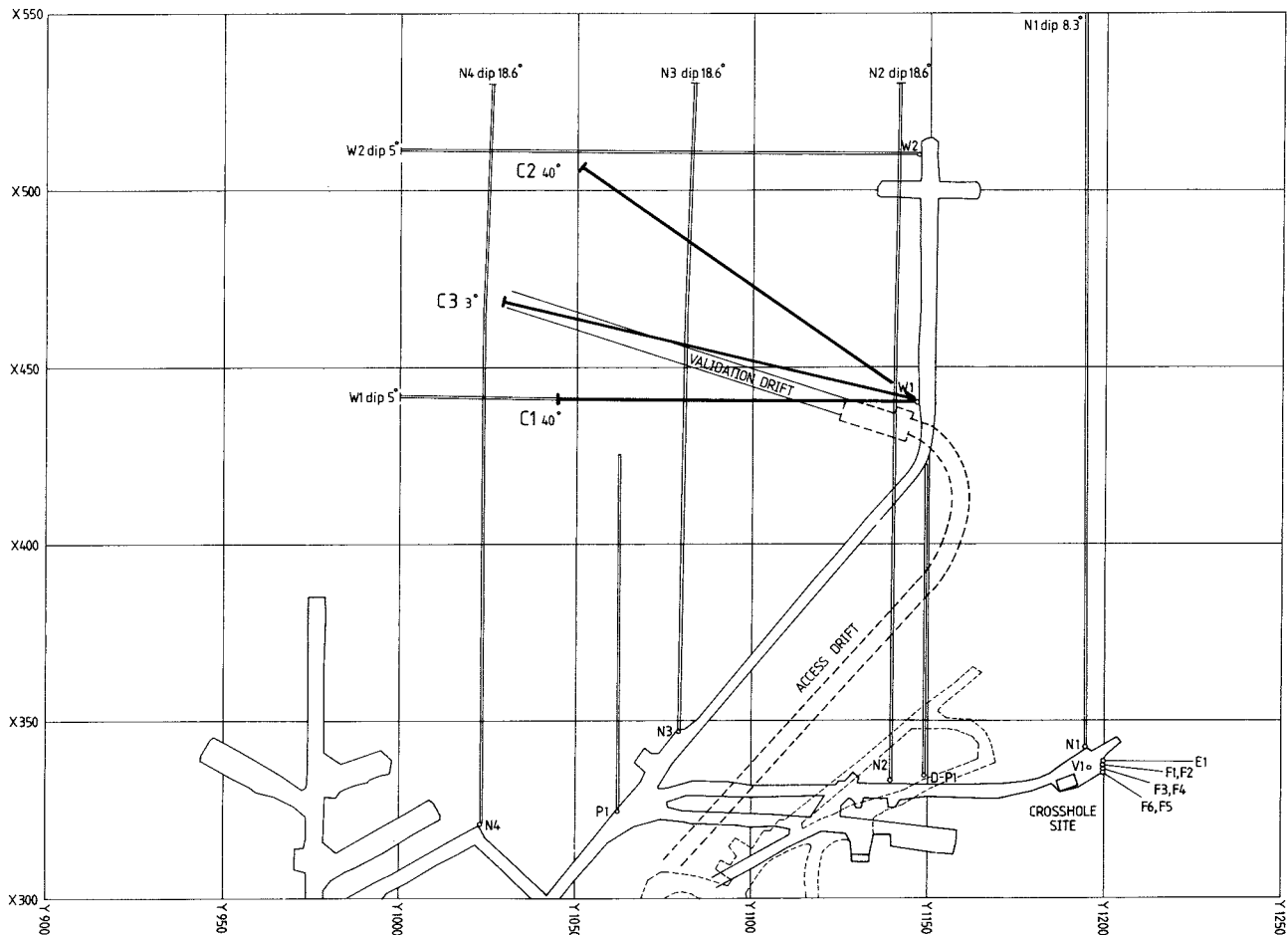

Figure 10-2. The C holes drilled during Stage 3 of the SCV programme and the access drift to the Validation Drift. The Validation Drift will be excavated during Stage 5 of the SCV programme.

geophysical methods will be determined in the drift. Furthermore, a new radar survey with salt injection will be carried out in order to evaluate whether the water paths identified in Stage 3 are stationary or whether the water has chosen new paths after excavation of the drift. This will give us some idea of the disturbed zone surrounding the validation drift and provide guidelines for injection of tracers in the concluding tracer tests. The tracer tests are to be regarded as a follow-up of the migration tests performed in the 3-D drift within the Phase 2 programme. The tracer tests will continue through the first half of 1991 and will thereby conclude the field portion of the SCV programme.

### 10.2.2 "Improvement of Site Assessment Concepts and Methods"

The programme is divided into five subprogrammes:

- **Development of directional antenna for borehole radar.** The new directional antenna system permits

determination of the orientation of a fracture zone by measurement in a single borehole. The previous technique necessitated the utilization of two boreholes for determining the orientation of a fracture zone. This development considerably approves the usefulness of the borehole radar technique, even though the range of the radar is slightly reduced when the new antenna is used. Development of the directional antenna for the borehole radar has nearly been completed and will be reported on during 1989.

- **Further refinement of technique for seismic cross-hole measurement.** Further refinement of the technique for seismic cross-hole measurement has primarily taken place within two areas: Development of a new type of signal source, and development of technique for processing and interpreting the results of the measurements. This new signal source generates a high-frequency coherent signal. This type of signal provides better resolution in the seismic measurements, facilitating interpretation of the results. Processing and interpretation of the

measurement results is simplified through improved algorithms for evaluation. Furthermore, the code used for vector analysis has been rewritten. The work of further refinement of the technique for seismic cross-hole measurements will continue until the latter part of 1991.

- **Network modelling for water flow in rock.** Financed by Stripa funds, the development of a discrete network model for simulation of water flow and transport in rock is under way at Harwell in England. In parallel with this work, similar models are being developed at LBL in California and at Golder in Seattle, USA. This work is being financed directly by US DOE, but benefits all the member countries of the Stripa Project. All three groups are working with discrete network modelling, but based on different concepts as regards fracture generation and representation in the model.

A Task Force with experts from the Stripa Project's member countries has been formed to provide support and viewpoints and to coordinate the work of the groups. At the initiative of the group, the different codes will be verified by comparing the results obtained from the processing of identical standard problems.

All model development is being applied to input data from the SCV area in the Stripa mine. A validation of the models will also be done against data from the validation drift. In brief, this validation consists of having the different groups predict the quantity and distribution of the water expected to flow into the validation drift, after which the predictions are compared with measured values.

- **Channelling tests.** The fundamental two-dimensional tests carried out during Phase 1 showed that the water is distributed unevenly over the fracture plane and that the flow in a fracture plane can be described in simplified terms as taking place in "channels" formed as a result of the irregular shape of the two fracture faces. The fracture faces come into contact with each other over large or small sections of the total fracture face, forming channels in which the water flows /10-17, 18/. Phase 3 includes a continuation of these tests aimed at shedding further light on the channelling phenomenon.

The phenomenon is being studied in two different types of tests: single-hole and double-hole tests. In the single-hole tests, which encompass about ten boreholes, the frequency of channels and the distance between the channels in a fracture plane are being determined. In the double-hole tests, the manner in which the channels are interlinked and whether water from different channels is mixed in the fracture plane is being studied. The results from the first two single-hole tests show that two fractures can have quite different water-conducting properties, even though they look similar when studied on the wall of the drift. The channelling tests will be concluded during 1989.

- **Hydraulic length and width of fractures.** This research area, new to Phase 3, is aimed at using single-hole measurements to obtain information on the hydraulic length of fractures and their connections to fracture systems that do not intersect the borehole being used for the measurements. The experiments are being conducted by performing water loss measurements in a borehole while the hole is under constant water pressure. The evaluation includes a detailed interpretation of the water losses in the entire hole as well as the distribution of the water losses along regular intervals of the borehole /10-19/. The results of the tests will be reported during 1989.

### 10.2.3 "Sealing of Fracture Rock"

Materials and technique for sealing fractures in rock around the final repository are being studied by means of a large research effort within Phase 3.

The work is being conducted with the support of a Task Force including experts from the member countries of the Stripa Project. This task force is not only offering viewpoints and support to the researchers who are primarily engaged in the research work, but is also contributing actively to the work and participating in the various research projects.

The programme is divided into two subprogrammes:

- **Materials for sealing fractured rock.** An extensive inventory has been made of all the different materials that could conceivably be used for injection grouting of fractured rock. The inventory indicates two materials, cement and bentonite, whose properties make them more suitable for the purpose than other materials /10-20/. An extensive programme is under way to determine the physical and chemical properties of these selected materials. Furthermore, work has begun on defining the long-term stability of the materials /10-21/. These laboratory studies will continue throughout the period encompassed by the Phase 3 programme.
- **Technique for sealing fractured rock.** Within the framework of the Stripa Project, a technique has been developed for injecting cement and bentonite into very fine fractures with an aperture down to 50 microns (0.05 mm). The technique entails superimposing a static pressure on a dynamic injection pressure. It has been tested and found to work very well on a laboratory scale and in field tests /10-21/. Four large-scale field tests with injection of fractured rock are currently being conducted in the Stripa mine. The tests will show how rock can be sealed in a number of practical situations that arise on a repository site /10-22/. Figures 10-3 and 10-4 illustrate the tests schematically. Test 1 involves sealing of the rock around two deposition holes. The intention is to investigate how effectively and to what distance from the deposition



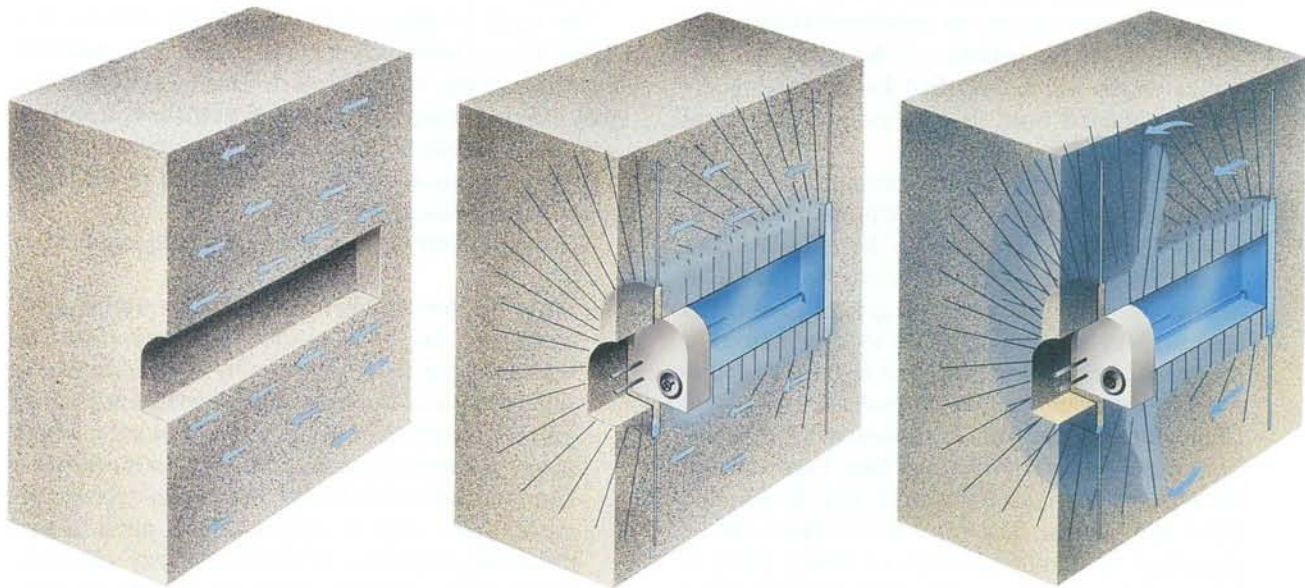
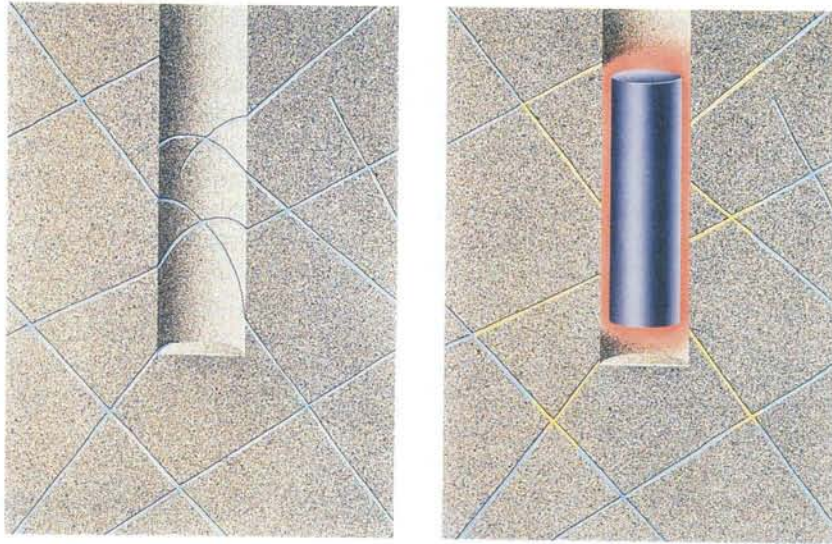

Figure 10-3. Test 1 involves sealing of the rock nearest the deposition holes. After injection grouting of the rock, heaters are placed in the holes. These heaters simulate the burnt-up fuel's influence on the sealed rock mass.

Figure 10-4. Tests 2 and 3 involve sealing of the disturbed zone around a deposition tunnel. Injection grouting of the rock is done to seal the rock nearest the tunnel.

holes the rock can be sealed. The grouted rock is heated to a temperature of about 90°C at the borehole periphery and to a temperature of 40°C at a distance of about one metre from the hole. Tests 2 and 3 entail sealing of the disturbed zone around the deposition tunnel. The purpose of test 2 is to identify whether a zone exists around an excavated tunnel whose hydraulic properties differ from the rest of the rock mass, and if so to find out how effectively this zone can be sealed by means of injection grouting. Test 3, which builds on test 2, is aimed at identifying whether a zone of rock with al-

tered hydraulic properties exists at a distance greater than the near zone of about 1.5 metres from the tunnel periphery that was sealed in test 2, and if so to determine how far out this stress-redistributed disturbed zone extends.

Test 4 entails sealing of a large fracture zone that intersects a deposition tunnel. The purpose is to investigate how effectively such a water-bearing natural zone can be sealed, and to demonstrate that sealing causes the water to seek new paths away from the deposition tunnel.

# 11 NATURAL ANALOGUES

## 11.1 GENERAL

The scope of studies concerned with natural analogues has increased substantially in recent years. This applies both within SKB and internationally. Thanks to cooperation between national programmes and a close link to the safety assessment and its model development, the yield of these studies has increased considerably. One example of important international initiatives is the formation of the National Analogue Working Group, NAWG, which works under the oversight of Euratom within the EC. A further example is a review of natural analogues and their role in the safety assessment carried out in 1987 by IAEA /11-1/. Natural analogues are also being dealt with within the international INTRAVAL project. SKB is participating actively in all of these activities.

NAWG has met annually since its start in 1985. Its formation was the result of the workshop on natural analogues that was held in Lake Geneva, Wisconsin, USA, in 1984. The meeting had been arranged by SKB in cooperation with US DOE. NAWG has established guidelines for selecting and using natural analogues within the different national waste programmes. In selecting an analogue it is important that the geochemical processes be distinct and measurable, that natural chemical elements exist that are analogues of important radionuclides, that physico-chemical parameters are measurable and that the time scale is known and comparable to that of the repository. The goals of an analogue study shall be to:

- study the results of the processes or groups of processes that are of importance for the long-term safety of the repository,
- find limits in the parameter values that will be used in the safety assessment,
- indicate what phenomena can be of importance,
- study the integral results of changes and reactions in a multicomponent system after a very long period of time,
- win broader understanding and acceptance for the safety of the final repository.

A number of large analogue studies are currently in progress at different places in the world. Among the more prominent ones are the studies at Poços de Caldas, Brazil; at Cigar Lake, Canada; at Alligator Rivers, Australia; and at Oklo, Gabon. SKB is involved in different ways in these studies. The Poços de Caldas project is managed by SKB. Our participation in the Cigar Lake project is currently being discussed with AECL in Canada. The results of the Alligator Rivers

project, ARAP, are being evaluated by experts with support from SKB within the INTRAVAL project.

The rock and the hydrology where the large analogue studies are being conducted can be different from that on the potential repository sites. This is compensated for by the fact that the phenomena and processes of interest are particularly pronounced due to, for example, high natural concentrations of radionuclides and radionuclide-like substances (such as at Poços de Caldas, Oklo, Alligator Rivers and Cigar Lake), or due to extreme and unique conditions such as the redox front at Poços de Caldas, the clay barrier at Cigar Lake and the natural reactor at Oklo. The emphasis in the analogue studies can be shifted to more repository-like geological and hydrogeological conditions at a later phase when experience and methods have been developed within the aforementioned projects. We therefore plan on future analogue studies in more repository-like rock.

## 11.2 POÇOS DE CALDAS

The Poços de Caldas project involves studies of natural analogues for the release and dispersal of radionuclides from a final repository. The investigations are tied to two closely-situated sites in the Poços de Caldas district in Minas Gerais, Brazil: the thorium deposit in Morro do Ferro and the Osamu Utsumi uranium mine, C-09.

Sweden (SKB), Great Britain (UK DoE), Switzerland (NAGRA), the USA (US DOE) and Brazil (Rio de Janeiro University, CNEN and NUCLEBRAS) are participating in the project.

The project will last three years under an agreement drawn up between SKB, UK DoE, US DOE and NAGRA, who are the direct sponsors. Brazil is serving as the host and is contributing some equipment and labour. SKB is in charge of the project management.

The investigations have been divided into three sub-projects:

- 1 Determination of speciation and chemical transport of natural radionuclides and rare-earth metals in a fracture flow system in crystalline rock under oxidizing and reducing conditions.
- 2 Formation and mobility of colloid-borne radionuclides in natural groundwaters (here, humic substances are also included in the term "colloids").
- 3 Thermal impact on the transport of natural radionuclides and rare-earth metals.

The most important goals of the subprojects are as follows:



Figure 11-1. Sampling at a redox front in the Osamu Utsumi uranium mine for analysis of the minerals.

Figure 11-2. Rock samples from the redox front. Precipitations of uranium in the form of pitchblende can be clearly distinguished as black spots.



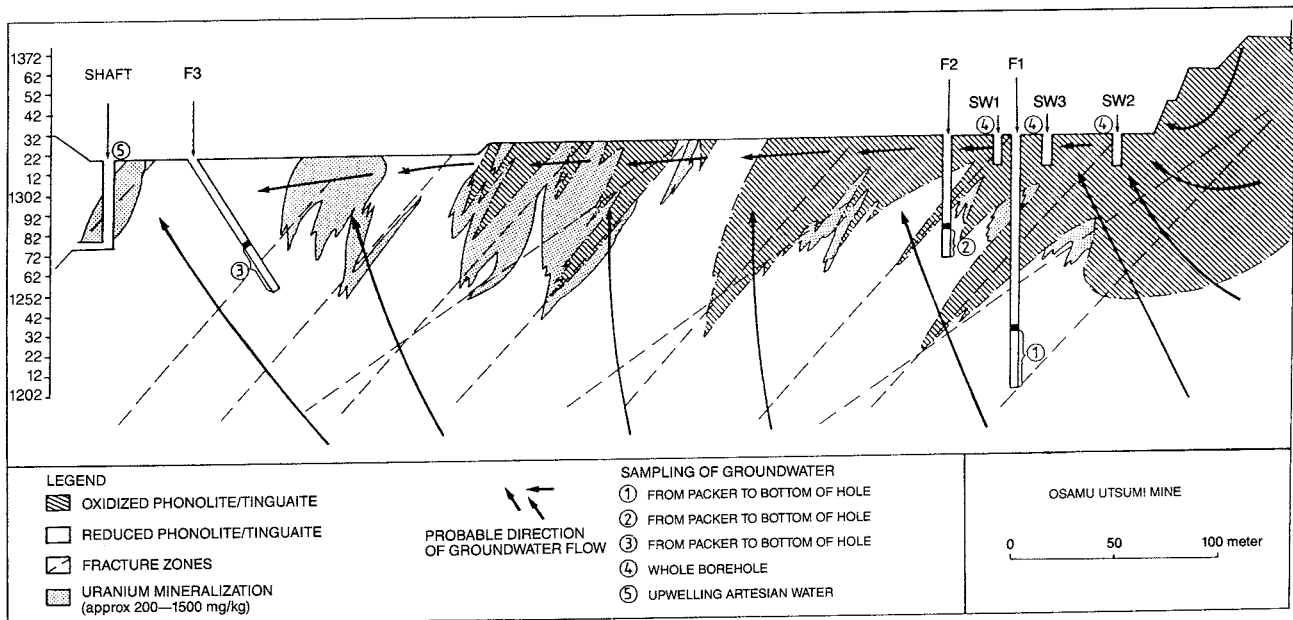

Figure 11-3. Profile through the sampling area in the open pit in the Osamu Utsumi uranium mine with some of the boreholes.

- 1 - Validate equilibrium models for different water/mineral systems.
  - Understand the mechanisms for the dissolution and precipitation of uranium and other elements around the redox front.
  - Compare retention factors from in-situ measurements with laboratory values.
  - Determine the occurrence and extent of diffusion in microfissures in the rock.
  - Determine the influence of microbes and microbial processes on radionuclide migration.
- 2 - Characterize and determine the concentration of natural colloids and organic complexes in the groundwater.
  - Determine the fraction of thorium, radium and rare-earth metals that are transported in the form of colloids and organic complexes.
- 3 - Measure and evaluate the distribution of analogue elements over a hydrothermal contact zone in the rock.
  - Determine the local extent of hydrothermal activity.
  - Determine the composition of the hydrothermal solutions and their influence on the permeability of the rock.
  - Understand the mechanism for hydrothermally influenced radionuclide transport.

The project started with an introductory phase in May 1986. Since then, five holes have been core drilled in the uranium mine, the deepest down to about 300 m, and four in Morro do Ferro, the deepest down to about 80 m. Microbial sampling and geological logging of the

cores is done in parallel with the drilling. This is followed by sampling of the cores for geochemical mineralogy. Geophysical logging and hydraulic testing of the boreholes is carried out. The boreholes are also used for extensive sampling of the groundwater and monitoring of any changes in the composition of the groundwater over approximately one year.

The field work was completed in the summer of 1989. The project is now in a phase when analyses are being supplemented, results evaluated and modelling carried out. Modelling is also being performed by researchers and groups with support outside the project. An important initiative has therefore been taken to coordinate these validation efforts. The coordinated modelling is being concentrated on the following subgoals: to increase the understanding of the descriptive models used for the safety assessment, to validate calculation models used in the safety assessment and to improve the database in such models.

### 11.3 CIGAR LAKE

Discussions are being held concerning cooperation with AECL in the Cigar Lake project in Canada.

The uranium mineralization is one of several similar ones in the area /11-2/. It is situated entirely underground at a depth of about 430 m, in contact with sandstone and underlying basement rock. The ore body is 2 km long, 25–100 m wide and 1–20 m deep. It is surrounded by a 5–30 m thick clay-rich halo that consists for the most part of illite, kaolinite and quartz. The ore and the surrounding clay zone were formed hydrothermally about 1.3 billion years ago when reducing hydrothermal solutions from the basement rock flowed

out into the sandstone. In many respects, Cigar Lake can be said to be a near-perfect analogue. It is illustrated by Table 11-1 (after /11-2/), which compares Cigar Lake

with the Canadian final repository concept, which in some respects is similar to KBS-3.

**Table 11-1. Comparison of Cigar Lake with the Canadian final repository concept.**

<b>Feature</b>	<b>Disposal concept</b>	<b>Cigar Lake</b>
Configuration	Spent fuel is isolated by a clay buffer at a depth of 500 to 1000 m in crystalline rock	Uranium ore is isolated by a clay-rich halo and covered by more than 350 m of sandstone.
Waste forms	Spent fuel (UO <sub>2</sub> ) More than 86% by weight of uranium	Uranium ore – mostly uraninite (UO <sub>2</sub> ), grading 12–55% by weight of uranium.
Buffer	Mixture of quartz and bentonite	Clay-rich halo in sand-stone, mostly illite with quartz.
	Assumed to sorb many elements from water, such as Cu, U and Zn	Evidence suggests that the clay has retained elements such as Cu, U and Zn.
Colloids	Radionuclide migration due to colloids assumed to be unimportant	Colloids formed in the ore zone are trapped in the clay-rich halo.
Time scale	Regulatory criteria require protection for at least 10 <sup>4</sup> years (Canada)	Uraninite ore has survived more than one billion years in water-saturated rock.
Thermal impacts	Predicted thermal transient of less than 100°C will last for more than 2 x 10 <sup>4</sup> years	Uranium mineralization formed by hydro-thermal solutions of about 150 to 200°C for more than 50 years.
Environmental impacts	Regulatory criteria place limitations on impacts to man and the environment	No indications (eg radiological, thermal, direct geophysical or geochemical) at the surface that the ore deposit exists.

## 12 BIOSPHERE STUDIES

### 12.1 THE IMPORTANCE OF THE BIOSPHERE STUDIES FOR THE FINAL DISPOSAL OF NUCLEAR WASTE

As is evident from previous chapters, the purpose of final disposal is to isolate the radioactive waste from the biosphere for such a long period of time that its radioactivity decays to a harmless level. To be able to determine the consequences of abnormal barrier function and demonstrate that the radiological consequences are insignificant, knowledge is required of how radionuclides behave in the biosphere. That portion of our world to which man normally has access is normally considered as the biosphere. The studies of the biosphere include the following processes and calculation steps significant for the safety assessment.

- Transport from groundwater in rock to a local ecosystem via different local recipients such as sediment, soil, water etc.
- Transport, dilution, accumulation and deposition in local, regional and global ecosystems.
- Calculation of individual doses and collective doses and comparison with natural conditions.

### 12.2 GOALS

The goal of SKB's studies of the properties of the biosphere and of the behaviour of radionuclides in the biosphere is to be able to carry out the consequence calculations in the safety assessment in a credible manner. Efforts will be concentrated on estimating the consequences of different release scenarios from a final repository in a time perspective in the order of 10 000 years. Subgoals in this process are to:

- attempt to quantify uncertainties due to the fact that the biosphere is constantly changing,
- improve the data on which the transport models are based,
- validate the models by means of studies of analogue transport processes.

### 12.3 PRESENT-DAY STATE OF KNOWLEDGE

#### 12.3.1 Evolution of the Biosphere

Any activity release from a final repository will probably take place so far ahead in time and over such a long

span of time that considerable changes are expected to occur in the properties of the biosphere before and during the process of release. This means that analyses of the consequences of a release will entail large uncertainties.

The greatest uncertainty factor is associated with the natural evolution of the ecosystems during the time periods considered realistic. Examples of processes in a shorter time perspective are:

- eutrophication of lakes and cultivation of old bottom sediments (due to land uplift as well),
- erosion of soils by wind and water,
- disturbance of sediment layering in lakes and waterways,
- urbanization, large paved surfaces, tunnels etc.

In a slightly longer perspective, climatic changes and glaciation must also be included in the picture. The biosphere then undergoes a very radical change and can re-emerge in a large number of ways. The question is, however, how meaningful it is to make dose estimates at this point.

Mankind utilizes the ecosystems for purposes such as food production and manipulate these systems to increase their yield. This can also be said to constitute a kind of evolution. Today's situation exhibits a large number of examples of this /12-7/. This impact can be of great importance for the consequence of a postulated release, especially if such phenomena as urbanization, large-scale hydroponics, dam construction or the greenhouse effect are included /12-13/. An inventory of reasonable events of this kind has been discussed in connection with SKB/SKI's joint scenario definition work.

SKB's efforts in recent years have been concentrated on the aging process of lakes, ie the process where the bottom sediment of the lakes is gradually transformed into farmland. A collection and processing of data for Trobbofjärden in Södermanland has been carried out /12-1,2,3/ including water flow, sedimentation rate, interstitial water characteristics, water quality during different phases etc. Modelling /12-4/ and variation analysis showed that the individual doses for certain nuclides increased by several orders of magnitude when the lake sediment was used as farmland. For other nuclides, the doses could decrease by a power of ten or so. The largest source of uncertainty is the rate of exchange in the lake's water and sediments. However, this scenario gives lower doses than when a well is assumed to be drilled into the waste disposal area. This project is expected to be concluded in 1990.

### **12.3.2 Transport Pathways between Rock and Man**

On their way to the surface, the groundwater and substances dissolved in it will leave the reducing environment in the rock and enter an oxidizing environment. For most relevant chemical compounds, this transition is associated with a drastic change in solubility. The transition often takes place in sediment or soil, but can also take place directly in free water. In the box models used previously, these processes have been approximated with transfer coefficients. Some studies /12-10,11/ show that greater consideration should perhaps be paid to this boundary layer, however.

A detailed investigation of outflow in lakes entitled "Nuclide transport in outflow areas" was initiated in 1987. In this study, sampling was performed in Lake Hillesjön and Lake Långhalsen in Södermanland to examine how the chemistry and fauna of the bottom sediments in outflow areas differ from those of other bottom sediments.

### **12.3.3 Other Research on the Biosphere**

Research concerning the dispersal of radionuclides in the biosphere, with some relevance for final disposal in geological formations, is being conducted by the Swedish University of Agricultural Sciences, the University of Gothenburg, FOA4 and to some extent by Studsvik and Kemakta under contract to SSI and SKI. Other Nordic research centres that can be mentioned are Risø in Denmark and VTT in Finland. Other research on chemical substances in the environment may be relevant in certain cases.

## **12.4 RESEARCH PROGRAMME 1990 – 1995**

### **12.4.1 Changes in the Biosphere**

The influence of climatic changes and ice ages, as well as human intervention, will be studied in connection with the work on systematic analysis of scenarios. See further Chapters 3 and 6.

The project concerning the aging of lakes will be concluded during the period.

### **12.4.2 Transport Pathways in the Biosphere**

Studies of "Nuclide transport in outflow areas" will be followed up with an investigation of the mobility of certain nuclides in sediments (including U, Tc, Cs). The role of sediments as a long-term and possibly ultimate sink for released radionuclides should be studied in greater depth.

Following the Chernobyl accident, a survey of the fallout in SKB's study sites Gideå and Finnsjön was initiated in 1986 /12-8/. This survey will continue for another five years. The project includes a sampling and measurement programme, studies of migration in soil profiles, sorption on and migration in rock, water-transported activity and modelling of nuclide turnover and transport /12-5,6/.

The goal of the sampling and measuring programme is to be able to utilize the migration of the nuclides in the fallout for verification and validation of models that describe turnover in the biosphere and geosphere. For the ground migration studies, the goal is to describe transport and retardation mechanisms for different nuclides in different soils so that models for this transport can be improved.

Binding of actinides and iodine on organic material in soils can be an essential factor for the exposure pathway via vegetables, meat and milk. The importance of the uncertainty in the turnover of the transuranic elements will be evaluated. Some experimental studies may have to be carried out.

### **12.4.3 Models and Data**

Dispersal calculations in KBS-3 were carried out with traditional box modelling based on available data on present-day ecosystems. Dose calculation is carried out with similar models utilizing radiophysical data and summarized in internationally accepted recommendations issued by ICRP.

Validation of models will continue to be carried out internationally within the IAEA/CEC project Validation of Model Predictions, VAMP, or a possible continuation of BIOMOVS /12-12/, and with the aid of data from the Chernobyl fallout in Gideå and Finnsjön. Some of the parameters used in the box models have been poorly studied for Nordic conditions. Sensitivity analyses will largely determine which parameters will be studied further during the coming six-year period.

### **12.4.4 Site-specific Studies**

For cases where releases do not begin until after many tens of thousands of years, when ice ages will probably have come and gone, the location of the repository cannot influence the biosphere transport of any nuclides released from the repository.

In scenarios where nuclide release takes place in a nearer future, however, the location of the repository will play some role in determining how the radionuclides are transported from the rock to the local ecosystems, and the properties of the points of outflow.

In scenarios where release is assumed to take place within a few thousand years, for example in the event of an initial canister damage, the site will be important for dispersal in local ecosystems, since present-day pre-

mises for land use can, by and large, be expected to persist during this time.

It is therefore of interest to carry out a site-specific model study, which should also take into account the local impact of the final repository. A suitable place for such a study is the Hard Rock Laboratory area. This should then be characterized with respect to the presence of natural radioactivity in superficial waters, groundwater conditions, outflow areas, soils, land use, biota, population etc so that less generalized models can be used /12-9/.

Similar investigations are also planned to be conducted on candidate sites proposed for the final repository.

#### **12.4.5 Acceptance Criteria**

The choice of radiological acceptance criteria is of great importance for how biosphere analyses are to be car-

ried out. The work of international agencies should be carefully followed (ICRP 46). The Swedish authorities will probably specify minimum requirements. In this context, comparisons between modellings and observations of outflows of natural nuclides in human surroundings, for example uranium-rich macadam production, can be of interest.

As in other countries, Swedish safety assessments have been based on the principle that "if man as individuals and as a group is protected, other biological species will not be threatened by radioactive releases". This principle has been applied to all types of releases, not only from waste storage facilities or final repositories. The principle has been questioned by some researchers in recent years and should be checked, if possible. This is mainly a task for the regulatory authorities that stipulate acceptance criteria. SKB intends to follow these developments.



## 13 INTERNATIONAL COOPERATION

Development within the field of nuclear waste management is performed to a great extent in international collaboration and exchange. Most countries with a nuclear power programme of any size have made plans for the management of different forms of radioactive waste and have begun the research and development that is considered necessary. International activities are therefore being conducted today on a large scale in the form of experiments, model development, site investigations, data compilations etc within the field of nuclear waste management, of which the Swedish efforts naturally constitute only a small part. The extent to which Sweden is able to derive direct benefit from the work being done in other countries is primarily dependent on the following two factors:

- technical and geological similarities in repository design and site,
- timetables for the execution of research programmes, large-scale tests and demonstration projects as well as the construction/operation of final repositories.

The benefit that Sweden can derive from other countries' research may lie on several different planes:

- contributions to method and model development,
- broadened and strengthened database,
- exploration of other alternatives for repository and barrier design, material selection etc,
- bolstering public confidence in the system through eg demonstration trials and large-scale tests.

An important part of SKB's programme is therefore to follow and profit from the research and development that is being conducted in other countries in a methodical and systematic manner. This task is made easier by the great interest shown internationally in the work being done in Sweden. This chapter contains a summary of some of the foreign programmes along with an overview of the different joint international projects in which SKB is directly involved.

### 13.1 FOREIGN R&D OF IMPORTANCE FOR SKB'S PROGRAMME

#### USA

The timetables in the USA are governed to a high degree by the Nuclear Waste Policy Act, which was passed in 1982. The Act has undergone far-reaching

changes, the most recent in 1987. The Act states that the federal government is responsible for the final disposal of high-level waste and spent fuel. US DOE, the Department of Energy, is responsible for building a final repository which, under the Act, must be able to receive waste no later than January 31, 1998. The American site has in principle already been selected as the most recent amendment to the Act, and resources are now being focussed on Yucca Mountain in Nevada. The repository is planned here at a depth of 400 m in water-unsaturated rock, providing about 200 m of unsaturated tuff as the primary geological barrier above the present-day groundwater table. Groundwater transport proceeds extremely slowly, about 0.1 mm/y according to calculations. The methodology for characterization of Yucca Mountain, model development, studies of waste forms and the safety assessment are of value for Sweden, even if the host medium is different. Direct contacts have been established with a number of specialists heading different projects in the American waste programme. A person from SKB is currently stationed at US DOE's office in Nevada.

#### Canada

AECL (Atomic Energy of Canada Ltd) is the federal organization in charge of Canada's nuclear power programme. AECL is also responsible for research and development on the conditioning and disposal of nuclear fuel waste. The provincially owned power utility Ontario Hydro is responsible for interim storage and transportation of spent nuclear fuel. The division of responsibilities between the federal government and the provincial governments when it comes to the final repository has not yet been defined. Canada's programme for final disposal consists of three phases:

- concept assessment,
- site selection,
- demonstration of disposal vault.

The first phase is currently under way. In a ten-year programme, research is being conducted in order to establish a scientific basis for geological disposal and for technical criteria for site selection and repository design. A proposal for a disposal method is to be presented to the authorities for review and assessment in the autumn of 1989. An extensive review process is foreseen, including public hearings, leading to a final assessment of the proposed concept in 1990–91. Site investigations and site selection are expected to take place during the 1990s. Once a site has been selected, a 20-year demonstration period is planned, concluding with expansion of the demonstration facility to a disposal

vault, which will be taken into operation after the year 2010.

The bedrock in Canada closely resembles the Scandinavian bedrock. Consequently, many of the geological investigations in Canada are of interest to Sweden. Of particular interest is the URL (Underground Research Laboratory) project where a shaft is being sunk to a depth of about 450 m in the bedrock. SKB has an agreement with ACL regarding participation in URL, see Section 13.4. Canada is also advanced in chemistry and in studies of spent fuel.

### **Finland**

According to Finnish law, responsibility for nuclear waste management in Finland rests with the nuclear power producers. The two power utilities, IVO and TVO, have formed a joint company, YJT, to coordinate the necessary research and development activities.

For spent nuclear fuel, the policy is to attempt to secure agreements whereby the spent fuel can be sent abroad for final disposal. In the case of the Loviisa reactors, such an agreement exists with the Soviet Union. Other nuclear fuel is to be stored temporarily and disposed of finally in Finland. A facility is being built at Olkiluoto for interim storage. A site for a final repository will be selected around the year 2000, and final disposal is expected to start around the year 2020.

A list of 101 sites of interest for a final repository obtained from an inventory was presented in early 1986. Preliminary investigations on 5–10 of these sites are being carried out during the period 1988–1992. These will be followed by detailed investigations on 2–3 sites up to the year 2000, when the final site will be chosen. Further investigations will be conducted on this site up to the time of a licence application around the year 2010.

Due to close similarities between the Swedish and the Finnish bedrock, an exchange of information is particularly valuable.

For low- and intermediate-level waste, TVO is currently building a final repository at Olkiluoto. The repository is being built at a depth of 70–100 m and is expected to be put into service in 1992. At the end of the 1990s, IVO will build a similar repository at Loviisa.

### **France**

Responsibility for final disposal of nuclear waste in France lies with an independent body, ANDRA, within Commissariat à l'Énergie Atomique, CEA. The research and development work is being conducted primarily by CEA. For high-level waste, the site selection question has been preceded by a reconnaissance of several hundred sites where granite, salt, argillaceous shale and sea sediment have been investigated. Site selection is very much a political question and recommendations for criteria were made in 1987 in the Gougel Report.

The site investigations will continue up to 1990. A site will then be selected for building an underground

laboratory, where more thorough measurements can supplement the earlier investigations. Toward the mid-1990s, the French authorities expect to have gathered sufficient material for the final selection of a system for the disposal of high-level waste.

Low- and intermediate-level waste has been stored since 1969 at La Manche. This repository will be full by the early 1990s. A new repository is therefore being built at Aube about 200 km south of Paris. This repository will be able to receive waste starting in 1991. The Aube repository will be able to accommodate 100 000 m<sup>3</sup> of short-lived waste, which is equivalent to about 30 years of nuclear power production. SKB has concrete cooperation with CEA within the fields of radionuclide chemistry and buffer/backfill.

### **West Germany**

West Germany intends to dispose of its high-level waste in a salt formation at Gorleben. No other site is currently being considered. An extensive investigation programme is being conducted at Gorleben, including sinking of two shafts down to repository depth. These investigations are expected to be completed by the beginning of the 1990s. It would then be possible to take a repository into operation at the end of the 1990s.

The geological studies in salt are of little interest to Sweden. However, along with Sweden, West Germany is the country that has explored the direct disposal alternative most systematically. The results of these studies were reported in the spring of 1985 in an extensive study, PAE, Projekt Andere Entsorgungstechniken. The PAE project is being carried further, aimed at a full-scale demonstration of certain features, eg canister fabrication and handling of encapsulated fuel. Most of the spent nuclear fuel from the West German programme will be reprocessed. Direct disposal may be used for certain odd fuel types. SKB is following the work on direct disposal in West Germany through an exchange of information with the PAE project.

Low- and intermediate-level waste will be disposed of in a former iron ore mine, Konrad. The licensing work for this final repository is expected to be able to start in the autumn of 1989. The commissioning date has not yet been determined and will depend on the results of public hearings held in 1990.

### **Switzerland**

According to the Atomic Energy Act in Switzerland, the nuclear power utilities are obliged to present a plan for final disposal of radioactive waste. The Swiss federal government and the Swiss nuclear power utilities have jointly formed NAGRA (Nationale Genossenschaft für die Lagerung Radioaktiver Abfälle) to manage the radioactive waste.

In 1985, NAGRA published its study Project Gewähr, an equivalent of the KBS-3 Report. The report recommends that high-level waste be disposed of at great depth in crystalline rock. An experimental station in

rock, equivalent to the Swedish Stripa mine, has been built at Grimsel in the Alps.

In June 1988, the Swiss Government approved Projekt Gewähr. However, they requested supplementary material concerning a concept for the storage of waste in sediment by 1990, and an evaluation report on all investigations in crystalline rock by the end of 1990. Site selection in Switzerland will take place around the year 2000, and a final repository is intended to be taken into service around the year 2020.

For repositories for low- and intermediate-level waste, NAGRA conducted investigations on three sites in the early 1980s. Due to local opposition and political impasses, these are not being considered. In June 1987, an application was submitted for permission to investigate a new site, Wellenberg. In August 1988, NAGRA received an approval from the federal authorities for tunnelling up to 100 m from the intended repository site. The necessary permits from local authorities had still not been obtained in May of 1989.

SKB maintains close contact with NAGRA and the Swiss programme. Direction cooperation and coordination of research is taking place within the fields of canister materials and natural analogues.

### Great Britain

During the 1970s, a programme of geological investigations for disposal in granite formations was initiated in Great Britain. In December 1981, further activities within this programme were postponed for at least 50 years on the grounds that it had been demonstrated that final disposal was possible in principle and that high-level waste can be temporarily stored without any problems for such a period of time. Consequently, no further decisions on final disposal of HLW are expected within the next few decades. R&D in Great Britain is therefore now being devoted solely to technology for vitrification of high-level waste, storage and model studies. Great Britain is also participating actively in the Stripa project, the Poços de Caldas project and NEA's seabed disposal studies.

For low- and intermediate-level waste, plans call for an SFR-like repository to be built below the seabed. The repository may be situated at a depth of about 1 000 m. In March 1989, it was decided that preparatory investigations will be carried out on two sites, Sellafield and Dounreay. The investigations are expected to be completed by 1992. After the final site has been selected, several years of public hearings and commenting rounds will follow. The final repository is expected to be put into service around 2005.

### EC

The EC is conducting an extensive and well-coordinated programme within the field of nuclear waste management. The work is being pursued in five-year programmes, and the most recent programme period extends from 1985 to 1989. The plan for the next pro-

gramme period, 1990–1995, includes the following points:

1. System studies and harmonization of member states' waste management policies.
2. Conditioning of radioactive waste.
3. Characterization of waste forms, encapsulation methods and canister materials.
4. Research on "development of underground repositories".
5. Safety assessments.

The work has thus far been done in the field at underground facilities at Asse in West Germany, Mol in Belgium and at the French experimental facility at Fanay-Augères.

During the next programme period, work is also planned to be done at a new French underground experimental facility. Site selection for this facility is planned in 1991, with commissioning in 1994. A similar facility is also planned in Great Britain, and the site for the facility is planned to be selected there around 1993.

Through SKB, Sweden is participating in several EC projects, for example the COCO Club (colloids and complexes), CHEMVAL and NAWG (National Analogue Working Group). See Section 13.10.

### Soviet Union

In 1988, a cooperation agreement was concluded with SCUAE (State Committee on the Utilization of Atomic Energy) in the Soviet Union regarding waste management. A first seminar with Soviet scientists was held in the spring of 1989. The Soviet programme appears to be focussed on disposal of reprocessed waste in salt formations. No concrete joint projects currently exist.

### Japan

Responsibility for the management of radioactive waste in Japan is shared between two government bodies: the Science and Technology Agency, STA, which is a part of the Government offices, and the Ministry of International Trade and Industry, MITI. STA conducts research and development in science and technology, while MITI is active on the industrial side of waste management.

The Power Reactor and Nuclear Fuel Development Co., PNC, and the Japan Atomic Energy Research Institute, JAERI, work under STA. PNC has been charged with the task of presenting a repository concept for high-level radioactive waste by 1992 and performing a safety assessment for it, while JAERI is working on geochemical questions and related safety assessment work.

The Central Research Institute of the Electric Power Industry, CRIEPI, works under MITI. CRIEPI works on behalf of the power utilities with safety assessment, instrument development and cost calculations.

Japan Nuclear Fuel Industries Company, Inc., JNFI, has overall responsibility for the low- and intermediate-level waste. They are currently planning a repository at Rokkashomura in the northern part of the country. The repository is planned to be commissioned in 1992.

In July 1989, SKB signed a cooperation agreement with JNFI regarding an exchange of information on the management of low- and intermediate-level waste.

### International Organizations

Overall international cooperation takes place within the UN's International Atomic Energy Agency, IAEA, and within OECD's Nuclear Energy Agency, NEA. These organizations are natural forums for information exchange within the field of radioactive waste, see Section 13.11.

## 13.2 SKB's COOPERATION AGREEMENTS WITH FOREIGN ORGANIZATIONS

SKB strives to utilize relevant results from development work in other countries in a systematic way. To this end, SKB has signed formal bilateral agreements with the following organizations in other countries:

- USA - US DOE (Department of Energy),
- Canada - AECL (Atomic Energy of Canada Ltd),
- Switzerland - NAGRA (Nationale Genossenschaft für die Lagerung Radioaktiver Abfälle),
- France - CEA (Commissariat à l'Énergie Atomique),
- EC - EUROATOM,
- Finland - TVO and IVO,
- Soviet Union - SCUAE (State Committee on the Utilization of Atomic Energy),
- Japan - JNFI (Japan Nuclear Fuel Industries Company, Inc.).

Information exchange without formal agreements also exists with:

- West Germany,
- Belgium,
- Great Britain,
- Other Nordic countries.

The formal agreements are similar in their construction and cover information exchange and cooperation within handling, treatment, storage and final disposal of radioactive waste. Exchange of up-to-date information (reports), as well as results and methods obtained from research and development, are main points in the agree-

ments. Arranging joint seminars and short visits of specialists to other signatories' facilities are other examples of what is included within the framework of the agreements. General reviews of the signatories' waste programmes and activity planning are held at approximately one-year intervals.

In the case of exchanges of personnel of long duration or extensive direct project cooperation, special agreements are generally concluded within the framework of the general agreement.

These agreements give specialists within the field of nuclear waste management greater opportunities for contacts and a fruitful exchange of up-to-date information.

## 13.3 THE JSS PROJECT - RESULTS

The JSS Project, which started in 1982, was concluded at the end of 1987. It was a joint project between CRIEPI (Japan), NAGRA (Switzerland) and SKB for studies of radioactive glass. In Phases I to III, the goals of the project were to:

- determine whether radioactive glass displayed different behaviour in any respect on contact with water than a chemically identical non-radioactive glass,
- build up an independent database for the glass that was to be delivered in the future from Cogema under existing reprocessing agreements.

The results showed that both the radioactive and the non-radioactive glasses exhibited, in all essential respects, the same behaviour on contact with water. In addition, the data obtained were of such high quality that they were judged to be able to serve as a basis for developing a predictive model for glass leaching under repository conditions. The project was therefore extended with Phases IV and V, which lasted from 1984 until the end of 1987. Besides model development, these phases also included supplementary experimental studies /13-1,2,3/ and studies of natural analogues /13-4/.

The results of Phase V show that a glass block of the Cogema type at 90°C would not be completely transformed within 10 000 years. At a lower temperature, the glass could have a much longer life. At 50°C, the time required for complete transformation of the glass approaches a million years. The escape of fission products and actinides from the glass is not dependent merely on the rate at which the glass is transformed, however, but also on the solubilities of secondary phases that can be formed and incorporate these nuclides.

### **13.4 COOPERATION WITH AECL REGARDING UNDERGROUND RESEARCH LABORATORY**

In the spring of 1987, a three-year cooperation agreement was concluded concerning characterization of the rock at the 240 m level in AECL's underground research laboratory, URL, in Manitoba, Canada.

The exchange has been of mutual benefit for AECL and SKB. To maximize the exchange of information, SKB has had specialists stationed at URL in different periods for the purpose of conducting joint projects. Thus far, the follow-up has been focussed on geology, rock mechanics and geohydrology, see further Section 6.2.2.1. Cooperation on groundwater chemistry will begin during the coming year.

### **13.5 FUEL LEACHING – WORKSHOPS**

Studies of the corrosion of high level fuel are only being conducted by a few laboratories in the world. The experimental work is both costly and time-consuming, since it has to be carried out in a hot cell. It is therefore important that opportunities be provided for an informal exchange of results and experience. The Spent Fuel Workshops that were started in 1981 at SKB's initiative have served as such a forum.

A total of eight workshops have been held since the start. From originally having participants only from Sweden, Canada and the USA, the group has been expanded. Participants have also been invited from countries that are interested in direct disposal of spent nuclear fuel but are not yet conducting any experimental investigations on high-level material.

### **13.6 HYDROCOIN**

This project consists of an international comparison and verification of different computer programs for groundwater flow. The project's third and last level is planned to be concluded during 1989. SKI is in charge of the project, which has been in progress since 1981.

Level 1 of the project, on which a final report has been submitted, aimed at verifying the numerical accuracy of the different computer programs. SKB has carried out calculations on three of the seven test cases with the program GWHRT /13-5/.

In level 2, which involves validation of models against field measurements or laboratory tests, SKB has participated in one of the test cases /13-6/. GWHRT has been used here as well.

Within level 3, sensitivity and uncertainty analyses will be carried out on seven different test cases. A final report has been submitted on SKB's participation.

### **13.7 INTRAVAL**

INTRAVAL is an international project whose purpose is to validate calculation models for radionuclide transport in the geosphere. The project is a follow-up of the previous projects HYDROCOIN and INTRACOIN. All of these projects were initiated by SKB, which also appointed the secretariat that coordinates the work within INTRAVAL.

A total of 14 test cases are included in the project, which involves evaluating the results of selected laboratory tests, field tests and studies of natural analogues. In many of the cases, it is possible for different model groups to perform predictive modelling before the measurement results have become available.

Five of the fourteen test cases are SKB-linked:

- laboratory tests of migration in overcored fractures/KTH,
- tracer tests at Finnsjön within the fracture zone project/SGAB,
- Stripa 3D migration/KTH,
- Poços de Caldas Project,
- colloid transport/BGS,
- redox front/KTH.

INTRAVAL is planned to continue until the end of 1990, with an option for extension for an additional three years.

### **13.8 COOPERATION WITH TVO, FINLAND**

Cooperation with TVO was initiated in 1988 regarding studies of the relationship between the microstructure and diffusion properties of clays. Measurements are being made at room temperature and elevated temperature with samples in measuring cells prepared at Clay Technology in Lund. Measurements with tracers are being performed at VTT in Helsinki, while rheology and conductivity are being studied in Lund.

A regular exchange of experience and technology for site investigation is taking place. Furthermore, Finnish representatives are included in the reference groups for the Lansjärv study and for the Hard Rock Laboratory.

TVO and SKB are jointly compiling existing knowledge on the importance of ice ages and related phenomena for the assessment of the repository's safety. Aside from this organized cooperation, information has been exchanged regarding deposition methodology, canister design, safety assessment and quality evaluations.

## 13.9 COOPERATION WITH CEA, FRANCE

### 13.9.1 Clay

SKB is currently cooperating with CEA in clay studies begun in 1985. The cooperation has included coordination of research projects and information exchange regarding relationships between the microstructure, mineralogy etc of smectite clays and the influence of temperature and irradiation. Hydrothermal tests and irradiation have been carried out during year-long experiments in the laboratory. The irradiation tests have been carried out on SKB's reference clay Mx80 and French smectite clay in a simulated canister environment in the laboratory at Saclay. Tests are being conducted at Stripa with highly compacted French smectite clay in a simulated deposition environment at approx. 170°C. Studies of rheological properties have been carried out in the laboratory in Sweden. The cooperation has provided good opportunities for comparisons between the two countries' reference clays for buffer materials, methods for measurement of properties, swelling pressure, hydraulic conductivity, thermal conductivity etc, and technical methods for deposition. During 1990, an overcoring is planned of a clay-filled borehole at Stripa in which tests have been conducted since 1986.

### 13.9.2 Chemistry

Within the framework of the bilateral cooperation agreement between CEA and SKB, experiments have been conducted to collect basic data on actinides. Similarly, experiments have been conducted regarding complexation between actinides and humic substances. Researchers from the Department of Inorganic Chemistry at KTH and Tema Vatten ("Theme Water") at the University of Linköping have participated on behalf of SKB. The cooperation has resulted in a number of publications, see also Chapter 7.

## 13.10 COOPERATION WITH EURATOM, EC

### 13.10.1 COCO

The working group COCO (Colloids and Complexes) was formed by CEC to explore the importance of colloids and organic complexes for the migration of radionuclides. An important part of the cooperation is comparative experiments with different methods used at different laboratories. SKB is supporting the participation of a Swedish specialist active within the field. Humic substances and colloids are difficult to define, and much

greater insight can be gained through cooperation of this kind.

### 13.10.2 CHEMVAL

CHEMVAL is a CEC project for verification and validation of chemical equilibrium calculation programs and coupled models for geochemistry transport.

Stage 1 involved verifying different equilibrium programs against each other and Stage 2 involved validating the programs against natural groundwaters.

Stage 3 involves verification of coupled models, and Stage 4 involves validation of these models. The project is also developing its thermodynamic database and performing sensitivity studies on equilibrium programs. Stages 1 and 2 are finished, Stages 3 and 4 are in progress. It is estimated that the entire project will be concluded by early 1990. SKB has had a group participating in the project from Stage 2 onwards.

## 13.11 COOPERATION WITHIN OECD NUCLEAR ENERGY AGENCY

### 13.11.1 RWMC

One of OECD/NEA's principal areas of cooperation is radioactive waste management in the member countries. These questions are dealt with by the Radioactive Waste Management Committee (RWMC), where SKB is represented through Tönis Papp. Some work is carried out in joint international projects, and work groups are formed to facilitate information exchange or prepare material as a basis for joint decisions or coordination.

Seminars and workshops are arranged within important areas to document and discuss the state of development and the direction of future work.

The groups and projects within the area of radioactive waste management where SKB is providing personnel or funding are listed below.

**PAAG (Performance Assessment Advisory Group)** functions in an advisory capacity to RWMC in matters pertaining to cooperation on means and methods for performance and safety analyses of final disposal systems.

Member from SKB: Tönis Papp

**ISAG (Advisory Group on In Situ Research and Investigations)** functions in an advisory capacity to RWMC in matters pertaining to the activities of the various underground research laboratories.

Member from SKB: Bengt Stillborg

**PSAC (Probabilistic Safety Assessment Code) Users Group** is a cooperation group between those who develop and those who use mathematical models for probabilistic analyses of repository systems. The emphasis lies on coordinating the development and comparing the quality of the models.

Member from SKB: Nils Kjellbert

**Cooperative Programme for the Exchange of Scientific and Technical Information Concerning Nuclear Installation Decommissioning Projects** is a forum for information exchange and cooperation on various decommissioning projects all over the world.

Member from SKB: Hans Forsström. SKB is also sponsoring a programme coordinator, Shankar Menon, Studsvik Energiteknik AB.

**Expert Group on Geochemical Modelling and Data** deals with matters of common interest within geochemistry, including the buildup of a common thermodynamic database TDB and augmentation of the database for sorption data, SDB. See Section 13.11.2.

Member from SKB: Fred Karlsson

**The Stripa Project** – see Chapter 10. The project manager and head of project administration is Bengt Stillborg.

Members from SKB: P-E Ahlström (chairman of Joint Technical Committee), Hans Carlsson, SGAB (member of Joint Technical Committee) and Bengt Stillborg (Project Manager).

### 3.11.2 TDB

The TDB Project (Thermochemical Data Base) is under the direction of OECD/NEA. The goal is to develop a chemical thermodynamic database for a number of elements that are of importance for the safety assessment of the final disposal of radioactive waste. The development of the database entails not only collecting and storing published data, but also critical review

/13-8,9,10,11,12/. Review is carried out by a group of international experts selected for each element. At present, uranium, neptunium, plutonium, americium and technicium are being reviewed. There are plans to include palladium, iodine, caesium, strontium, radium and lead as well.

The TDB Project is a very valuable initiative to develop a well-documented, reviewed and internationally accepted database. SKB is supporting the activity and Swedish experts are participating in the review work. For SKB, as well as for other participants, it will naturally be necessary to have an operational database available before TDB for different calculation purposes. However, the results from TDB will be incorporated as they become available. A good example of this is the Uranium Database at SKB.

## 13.12 COOPERATION WITHIN IAEA

Cooperation is also being conducted within the International Atomic Energy Agency, IAEA, concerning the management of radioactive waste.

The cooperation is being conducted in different ways, including the publication of reports consisting of:

- proceedings from international symposia,
- guidelines and standards within established areas of activity,
- status reports and methodology descriptions within important areas undergoing rapid development.

IAEA recently appointed an expert advisory group for its waste management programme (the International Waste Management Advisory Committee, INWAG) and arranges for information exchanges within different special areas through Joint Research Programmes. IAEA publishes an annual catalogue on current research projects within the waste management field in the member countries.

SKB often participates with experts in the compilation or review of the above kinds of reports and has an observer, Per-Eric Ahlström, in INWAG.

# REFERENCES PART II

## Chapter 2

### 2.1 R&D-Programme 86 1986

Handling and final disposal of nuclear waste.  
Programme for research, development and other measures.  
SKB, Stockholm

### 2.2 Granskning av FoU-program 86 1987

“Review of R&D-Programme 86, 1987”  
(In Swedish)  
SKN, Stockholm

### 2.3 Final storage of spent nuclear fuel – KBS-3. May 1983

Parts I–IV.  
SKBF/KBS, Stockholm

### 2.4 Röshoff K 1988

Characterization of the morphology, basement rock and tectonics in Sweden.  
SKB Technical Report TR 89-03, Stockholm

### 2.5 Kornfält K-A, Larsson K 1987

Geological maps and cross-sections of Southern Sweden.  
SKB Technical Report TR 87-24, Stockholm

## Chapter 3

### 3-1 Andersson J, Carlsson T, Eng T, Kautsky F, Söderman E, Wingefors S

The joint SKI/SKB scenario development project.  
(In print)

### 3-2 Sellin P, Ström A 1989

Modellkatalogen – Datormodeller inom SKBs forskningsverksamhet.  
“The model catalogue – Computer models within SKB’s research programme.”  
(In Swedish)  
SKB Work Report AR 89-04, Stockholm

### 3-3 Wolery T J 1979

Calculation of chemical equilibrium between aqueous soluble minerals: the EQ3/6 software package, Lawrence Livermore National Laboratory.  
UCRL-52658

### 3-4 McKenzie W F, Wolery T J, Delany J M, Silva R J, Jackson KJ, Bourcier W L, Emerson D O 1986

Geochemical modelling (EQ3/6) plan. Office waste management program, Lawrence Livermore National Laboratory.  
UCID-20864

### 3-5 Kjellberg N A, Wallin G, Ooppelstrup J 1989

PROPER – A computer package for uncertainty analysis in performance assessment.  
(In print)

### 3-6 Norman S, Kjellberg N 1989

NEAR 21 – A near-field radionuclide migration code for use with the PROPER package.  
(In print)

### 3-7 Norman S, Söderberg P, Kjellbert N 1989

FARF31 – A far-field radionuclide migration code for use with the PROPER package.  
(In print)

### 3-8 The geodatabase, introduction to GEOTAB SKB Work Report AR 89-xx, Stockholm (In print)

### 3-9 Gentzschein B 1986

Description of hydrogeological data in SKB’s database GEOTAB.  
SKB Technical Report TR 86-22, Stockholm

### 3-10 Sehlstedt S 1988

Description of geophysical data in the SKB database GEOTAB.  
SKB Technical Report TR 88-05, Stockholm



**3-11 Stark T**  
**1988**  
Description of geological data in the SKB database GEOTAB.  
SKB Technical Report TR 88-06, Stockholm

**3-12 Eriksson E, Sehlstedt S**  
**1989**  
Description of background data in the SKB database GEOTAB.  
SKB Technical Report TR 89-02, Stockholm

**3-13 OECD/NEA**  
**March 1988**  
Ad hoc meeting on the Application of Optimization of Protection in Regulation and Operational Practice.

**3-14 Papp T, Sellin A, Ström A**  
SKB 91  
1990–1991 års säkerhetsanalys.  
("1990–1991 safety assessment.")  
(In Swedish)  
SKB Work Report AR 89-xx, Stockholm  
(In print)

## Chapter 4

**4-1 Underlagsrapport till FoU-program 86**  
**Alternativa slutförvaringsmetoder.**  
("Background report to R&D-Programme 86  
Alternative final disposal methods.")  
**Sept 1986**  
(In Swedish)  
SKB, Stockholm

**4-2 Alternativa tidplaner för hantering av använt**  
**kärnbränsle**  
("Alternative timetables for management of  
spent nuclear fuel  
Consequences for planning, safety and costs.")  
**Dec 1985**  
(In Swedish)  
SKB Work Report AR 85-18, Stockholm

**4-3 Granskning av FoU-program 86**  
("Review of R&D-Programme 86")  
**May 1987**  
(In Swedish)  
SKN, Stockholm

**4-4 NAK WP-Cave Project**  
**Nov 1985**  
Report on the research and development stage May  
1984 – 1985, Boliden WP Contech AB.  
SKN Report 16, Stockholm

**4-5 Vattenfall, BEL**  
**1988**  
Storage of nuclear waste in very deep boreholes. Feasibility study and assessment of economic potential.  
Stage 3: Outline design and quality assurance review.  
SKB Work Report AR 88-56, Stockholm

**4-6 WP-Cave – assessment of feasibility, safety and**  
**development potential**  
SKB Technical Report TR 89-20, Stockholm  
(In print)

## Chapter 5

**5-1 Kärnbränslesäkerhet**  
**1987**  
Handling and final storage of unprocessed spent nuclear fuel.  
KBS, Stockholm

**5-2 Boulton J, ed.**  
**1978**  
Management of radioactive fuel wastes: The Canadian disposal program, Atomic Energy of Canada Ltd.  
Report No. AECL-6314

**5-3 Johnson L H, Shoesmith D W**  
**1988**  
Radioactive waste form for the future, W Lutze and R C Ewing, eds, Elsevier Science Publishers B V.

**5-4 Werme L O, Forsyth R S**  
**1989**  
The SKB spent fuel corrosion programme. Status Report 1988.  
SKB Technical Report TR 89-14, Stockholm

**5-5 Forsyth R S, Werme L O, Bruno J**  
**1988**  
J Nucl. Mater. 160 (1988) 218

**5-6 Garisto N, Garisto F**  
**1988**  
Atomic Energy of Canada Ltd.  
Report No. AECL-9562

**5-7 Skålberg M, Eliasson L, Skarnemark G,**  
**Torstenfelt B, Forsyth R, Holmér A, Winqvist B,**  
**Allard B**  
**1988**  
Sci. Tot. Environment 69 (1988) 347

- 5-8 Puigdomènech I, Bruno J**  
1988  
Modelling uranium solubilities in aqueous solutions: Validations of a thermodynamic database for the EQ3/6 geochemical codes.  
SKB Technical Report TR 88-21, Stockholm
- 5-9 Hallberg R O, Östlund P, Wadsten T**  
1988  
Appl. Geochem. 3 (1988) 273
- 5-10 Ekbohm L B, Bogegård S**  
1989  
Copper produced from powder by HIP to encapsulate nuclear fuel elements.  
SKB Technical Report TR 89-10, Stockholm
- 5-11 Ivarsson B, Österberg J-O**  
1988  
Creep properties of welded joints in OFHC copper for nuclear waste containment.  
SKB Technical Report TR 88-20, Stockholm
- 5-12 Marsh G P, Bland I D, Taylor K J**  
1988  
Br. Corros. J. 23 (1988) 157
- 5-13 Mattsson H, Li C**  
1989  
Titanium exposed in water saturated bentonite clay: Exposures ranging up to six years.  
SKB Technical Report TR 89-xx, Stockholm  
(In print)
- 5-14 Hultquist G**  
1986  
Corr. Sci. 26 (1986) 173
- 5-15 Simpson J P, Schenk R**  
1987  
Corr. Sci. 27 (1987) 1365
- 5-16 Eriksen T E, Ndalamba P, Grenthe I**  
1988  
On the corrosion of copper in pure water.  
SKB Technical Report TR 88-17, Stockholm
- 5-17 Technical Advisory Committee to Atomic Energy of Canada Limited on Nuclear Fuel Waste Management Program**  
Seventh Annual Report, Ontario, Canada, 1986.
- 5-18 Smectite alteration**  
November 1984  
Proceedings of a workshop convened at the Shoreham Hotel, Washington, D.C., December 8-9, 1983.  
Compiled by Duwayne M Anderson, Texas A & M University.  
SKB Technical Report TR 84-11, Stockholm
- 5-19 Pusch R, Karnland O**  
June 1988  
Hydrothermal effects on montmorillonite. A preliminary study.  
SKB Technical Report TR 88-15, Stockholm
- 5-20 Erlström M**  
December 1986  
Pressure solution of minerals in quartz-type buffer materials.  
SKB Technical Report TR 86-28, Stockholm
- 5-21 Pusch R**  
December 1986  
Settlement of canisters with smectite clay envelopes in deposition holes.  
SKB Technical Report TR 86-23, Stockholm
- 5-22 Pusch R, Börgesson L, Ramqvist G**  
August 1985  
Final report of the buffer mass test – Volume II: Test results.  
Stripa Project Technical Report TR 85-12, SKB, Stockholm
- 5-23 Pusch R, Erlström M, Börgesson L**  
May 1987  
Piping and erosion phenomena in soft clay gels.  
SKB Technical Report TR 87-09, Stockholm
- 5-24 Pusch R, Hökmark H**  
1987  
Megapermeameterstudie av gastransport genom SFR-buffertar.  
("Megapermeameter study of gas transport through SFR buffers.")  
(In Swedish)  
SFR Work Report 87-06, Stockholm
- 5-25 Pusch R, Hökmark H, Börgesson L**  
June 1987  
Outline of models of water and gas flows through smectite clay buffers.  
SKB Technical Report TR 87-10, Stockholm

- 5-26 Pusch R, Börjesson L, Ramqvist G**  
**January 1987**  
Final report of the borehole, shaft and tunnel sealing test – Volume I: Borehole plugging.  
Stripa Project Technical Report TR 87-01, SKB, Stockholm
- 5-27 Pusch R, Börjesson L, Ramqvist G**  
**January 1987**  
Final report of the borehole, shaft and tunnel sealing test – Volume II: Shaft plugging.  
Stripa Project Technical Report TR 87-02, SKB, Stockholm
- 5-28 Pusch R, Börjesson L, Ramqvist G**  
**February 1987**  
Final report of the borehole, shaft and tunnel sealing test – Volume III: Tunnel plugging.  
Stripa Project Technical Report TR 87-03, SKB, Stockholm
- 5-29 Pusch R, Erlström M, Börjesson L**  
**December 1985**  
Sealing of rock fractures. A survey of potentially useful methods and substances.  
SKB Technical Report TR 85-17, Stockholm
- 5-30 State-of-the-art report on potentially useful materials for sealing nuclear waste repositories.**  
**June 1987**  
Stripa Project Technical Report TR 87-12, SKB, Stockholm
- 5-31 Pusch R, Börjesson L, Erlström M**  
**December 1987**  
Alteration of isolating properties of dense smectite clay in repository environments and exemplified by seven pre-quaternary clays.  
SKB Technical Report TR 87-29, Stockholm
- 5-32 Erlström M, Pusch R**  
**December 1987**  
Survey of Swedish buffer material candidates and methods for characterization.  
SKB Technical Report TR 87-32, Stockholm
- 5-33 Pusch R, Karnland O**  
**December 1986**  
Aspects of the physical state of smectite-adsorbed water.  
SKB Technical Report TR 86-25, Stockholm
- 5-34 Börjesson L, Pusch R**  
**December 1987**  
Rheological properties of a calcium smectite.  
SKB Technical Report TR 87-31, Stockholm
- 5-35 Börjesson L, Hökmark H, Karnland O**  
**December 1988**  
Rheological properties of sodium smectite clay.  
SKB Technical Report TR 88-30, Stockholm
- 5-36 Börjesson L**  
**December 1986**  
Modern shear tests of canisters with smectite clay envelopes in deposition holes.  
SKB Technical Report TR 86-26, Stockholm
- 5-37 Börjesson L**  
**December 1988**  
Modelling of buffer material behaviour.  
Some examples of material models and performance calculations.  
SKB Technical Report TR 88-29, Stockholm
- 5-38 Pusch R, Karnland O**  
**December 1988**  
Geological evidence of smectite longevity.  
The Sardinian and Gotland cases.  
SKB Technical Report TR 88-26, Stockholm

## Chapter 6

- 6-1 Bergman S G A, Carlsson A**  
**1986**  
Förundersökningar i berg. Rekommendationer för förundersökningar, prognoser och utlåtanden.  
("Pre-investigations in rock. Recommendations for pre-investigations, predictions and statements.")  
(In Swedish)  
BeFo Foundation, Stockholm
- 6-2 Gustafson G, Stanfors R, Wikberg P**  
**1988**  
The Swedish Hard Rock Laboratory – First evaluation of pre-investigations 1986–1987 and target area characterization.  
SKB Technical Report TR 88-16, Stockholm
- 6-3 Gustafson G, Stanfors R, Wikberg P**  
**1989**  
Swedish Hard Rock Laboratory – Evaluation of 1988 year pre-investigations and description of the target area, the island of Äspö.  
SKB Technical Report TR 89-16, Stockholm
- 6-4 Henkel H**  
**1988**  
Tectonic studies in the Lansjärv region.  
SKB Technical Report TR 88-07, Stockholm

- 6-5 Stone D, Kaminen D C**  
**1988**  
Recognition of low-intermediate-dip fracture zones at surface; an example from permit area D, Lac Du Bonnet batholith.  
AECL TR-465. Pinawa, Manitoba
- 6-6 Stanfors R**  
**1987**  
The Bolmen tunnel project. Evaluation of geophysical site investigation methods.  
SKB Technical Report TR 87-25, Stockholm
- 6-7 Dahl-Jensen T, Lindgren J**  
**1987**  
Shallow reflection seismic investigation of fracture zones in the Finnsjö area, method evaluation.  
SKB Technical Report TR 87-13, Stockholm
- 6-8 AECL**  
**1988**  
Semi-Annual Status Report of the Canadian nuclear fuel waste management programme 1987 October 1 – 1988 March 31.  
AECL TR-425 – 4, Pinawa, Manitoba
- 6-9 Gougel J**  
**1987**  
Stockage des déchets radioactifs en formations géologique, Critères techniques de choix de site. Ministère de L'industrie de P & T et du Tourisme, Paris
- 6-10 Ahlbom K, Smellie J (eds)**  
**1989**  
Characterization of fracture zone 2, Finnsjön study site.  
SKB Technical Report TR 89-19, Stockholm
- 6-11 Carlsson L, Winberg A, Arnefors J**  
**1986**  
Hydraulic modelling of the final repository for reactor waste (SFR). Compilation and conceptualization of available geological and hydrogeological data.  
SKB Progress Report SFR 86-03, Stockholm
- 6-12 Olsson O, Palmqvist K**  
**1989**  
Radar investigations at the Saltsjö tunnel – predictions and validation.  
SKB Technical Report TR 89-18, Stockholm
- 6-13 Andersson P, Andersson P, Gustafsson E, Olsson O**  
**1989**  
Investigation of flow distribution in a fracture zone, using the radar method.  
SKB Technical Report TR 89-xx, Stockholm  
(In print)
- 6-14 Pihl J, Hammarström M, Ivansson S, Morén P**  
**1986**  
Crosshole investigations – Result from seismic borehole tomography.  
Stripa Project Technical Report TR 87-06, SKB, Stockholm
- 6-15 Cosma, C**  
**1987**  
Crosshole investigations – short and medium range seismic tomography.  
Stripa Project Technical Report TR 87-08, SKB, Stockholm
- 6-16 Tullborg E-L**  
**1986**  
Fissure fillings from the Klipperås Study Site.  
SKB Technical Report TR 86-10, Stockholm
- 6-17 Bäckblom G, Stanfors R**  
**(eds) 1989**  
Studies of postglacial faulting in the Lansjärv area, northern Sweden.  
SKB Technical Report TR 89-xx, Stockholm  
(In print)
- 6-18 Carlsten S, Olsson O**  
**1989**  
Comparison between radar data and geophysical, geological and hydrological borehole parameters by multivariate analysis of data.  
SKB Technical Report TR 89-15, Stockholm
- 6-19 Neuman S H**  
**1988**  
A conceptual framework and methodology for investigating flow and transport in Swedish crystalline rocks.  
SKB Work Report AR 88-37, Stockholm
- 6-20 Osnes J D, Winberg A, Andersson J E**  
**1989**  
Analysis of well-test data – application of probabilistic models of infer hydraulic properties of fractures.  
SKB Technical Report TR 89-xx, Stockholm  
(In print)

- 6-21 Carlsson L, Grundfelt B, Winberg A  
1987**  
Hydraulic modelling of final repository for reactor waste (SFR).  
SKB Progress Report SFR 86-07, Stockholm
- 6-22 Martin C D, Christiansson R, Kroll D W  
1989**  
In-situ measurements in highly stressed granite. Part I  
– Comparison of USBM and modified CSIR overcore devices.  
SKB Work Report AR 88-43, Stockholm
- 6-23 Christiansson R  
1989**  
Bergspänningsmätning genom överborrning – fördelar och begränsningar. Bergmekanikdagen 1989, 33–56.  
("Rock stress measurement through overcoring – advantages and limitations. Rock Mechanics Day 1989, 33–56.")  
BeFo Foundation, Stockholm
- 6-24 Carlsson H, Carlsson L, Pusch R  
1989**  
Rock quality designation of the hydraulic properties in the near field of a final repository for spent nuclear fuel.  
SKB Technical Report TR 89-21, Stockholm  
(In print)
- 6-25 Abelin H, Neretnieks I, Tunbrant S, Moreno L  
1985**  
Final report of the migration in a single fracture – Experimental results and evaluation.  
Stripa Project Technical Report TR 85-03, SKB, Stockholm
- 6-26 Abelin H  
1986**  
Migration in a single fracture. An in-situ experiment in a natural fracture, Ph.D. Thesis.  
Department of Chemical Engineering, Royal Institute of Technology, Stockholm
- 6-27 Abelin H, Birgersson L, Gidlund J, Moreno L, Neretnieks I, Widén H, Ågren T  
1987**  
Part I 3-D migration experiment – Report 3 performed experiments, results and evaluation.  
Stripa Project Technical Report TR 87-21, SKB, Stockholm
- 6-28 Moreno L, Neretnieks I  
1988**  
Channelling in fractured zones and its potential impacts on transports of radionuclides. Symp scientific basis for nuclear waste management, Berlin
- 6-29 Palmqvist K, Stanfors R  
1987**  
The Kymmen power station – TBM tunnel. Hydrogeological mapping and analysis.  
SKB Technical Report TR 87-26, Stockholm
- 6-30 Pusch R  
1989**  
Alteration of the hydraulic conductivity of rock by tunnel excavation.  
Int J Rock Mech. Vol 26, No. 1, 79, 83
- 6-31 Winberg A, Chan T, Griffiths P, Nakka B  
1989**  
Post-excavation analysis of a revised Room 209 fracture. A part of the joint AECL/SKB characterization of the 240 level at the URL, Manitoba, Canada.  
SKB Technical Report TR 89-xx, Stockholm  
(In print)
- 6-32 Rhen I, Åkesson J Å  
1988**  
Hylteprojektet. Geologisk undersökning av sprickzon vid Hylte kraftverk.  
("The Hylte Project. Geological survey of fracture zone at Hylte power station.")  
(In Swedish)  
SKB Work Report AR 88-26, Stockholm
- 6-33 Larsson N Å, Markström A  
1988**  
Groundwater numerical modelling of the Fjällveden study site – Evaluation of parameter variations. A HYDROCOIN study – Level 3, case 5 A.  
SKB Technical Report TR 88-11, Stockholm
- 6-34 Bear J  
1979**  
Hydraulics of groundwater.  
McGraw-Hill
- 6-35 Lindbom B, Lundblad K, Winberg A  
1989**  
Parameter variations of the groundwater flow modelling at the Klipperås site; Regional and subregional scale.  
SKB Work Report AR 89-05, Stockholm

- 6-36 Thunvik R, Braester C**  
1988  
GWHRT – A flow model for coupled groundwater and heat flow – version 1.0.  
SKB Technical Report TR 88-10, Stockholm
- 6-37 Thunvik R**  
1987  
Calculations on HYDROCOIN level 1 using the GWHRT flow model. Cases 1,3 and 4.  
SKB Technical Report TR 87-03, Stockholm
- 6-38 Thunvik R**  
1987  
Calculations on HYDROCOIN level 2, case 1 using the GWHRT flow model.  
SKB Technical Report TR 87-04, Stockholm
- 6-39 OECD/NEA**  
1988  
The international HYDROCOIN project – Level 1: Code verification.
- 6-40 Andersson J, Dverstorp B**  
1987  
3-D migration experiment – Report 4 fracture network modelling of the Stripa 3-D Site.  
Stripa Project Technical Report TR 87-22, SKB, Stockholm
- 6-41 Andersson J**  
1988  
Application of discrete fracture network models at site characterization and safety analyses.  
SKB Work Report AR 88-35, Stockholm
- 6-42 Gelhar L W**  
1987  
Applications of stochastic models to solute transport in fractured rocks.  
SKB Technical Report TR 87-05, Stockholm
- 6-43 Golder Associates Inc**  
1989  
Fracture flow code – Cross-verification plan – Revision 1.0.  
Golder Associates, Redmond WA
- 6-44 Herbert A W**  
1988  
NAPSAC stochastic fracture network modelling code: Technical summary.  
Release 1A AERE Harwell Laboratory
- 6-45 Golder Associates Inc**  
1988  
MAFIC version 1.0: Matrix and fracture interaction code: User documentation.  
Golder Associates, Redmond WA
- 6-46 Golder Associates Inc**  
1988  
FracMan version 2.0: Interactive rockfracture geometric model: User documentation.  
Golder Associates, Redmond WA
- 6-47 Moreno L, Tsang Y, Tsang C F, Neretnieks I**  
1988  
Flow and solute transport in a single fracture. A two-dimensional statistical model.  
SKB Technical Report TR 88-03, Stockholm
- 6-48 Paige R W, Piper D**  
1988  
Capabilities and requirements for modelling radionuclide transport in the geosphere.  
UK/DOE/RW/89/024/, London
- 6-49 Ahlbom K, Andersson P, Ekman L, Gustafsson E, Smellie J, Tullborg E-L**  
1986  
Preliminary investigations of fracture zones in the Brändan area, Finnsjön study site.  
SKB Technical Report TR 86-05, Stockholm
- 6-50 Gentzchein B, Nilsson G, Stenberg L**  
1987  
Preliminary investigations of fracture zones at Ävrö – results of investigations performed July 1986 – May 1987.  
SKB Progress Report PR 25-87-16, Stockholm
- 6-51 Pusch R, Börgesson L, Ramqvist G**  
1985  
Final report of the buffer mass test – Volume II: test results.  
Stripa Project Technical Report TR 85-12, SKB, Stockholm
- 6-52 Thunvik R, Braester C**  
1987  
Calculation of gas migration in fractured rock.  
SKB Technical Report TR 87-18, Stockholm
- 6-53 Braester C, Thunvik R**  
1987  
Calculation of gas migration in fractured rock – a continuum approach.  
SKB Technical Report TR 87-19, Stockholm

- 6-54 Hakami E**  
1988  
Water flow in single rock joints. Licentiate Thesis 1988:11L.  
Tekniska Högskolan in Luleå, Luleå
- 6-55 Thunvik R, Bao Y-B**  
1989  
GWHRT-S – Documentation of computer program for sensitivity analysis of groundwater flow, Version 1.0.  
SKB Work Report AR 88-55, Stockholm
- 6-56 Heinrich W F (ed)**  
1984  
Proc. workshop on transitional processes. Ottawa 1982.  
AECL-7822. Pinawa, Manitoba
- 6-57 Nurmi P**  
1985  
Mahdolliset ympäristöolosuhteiden pitkäaikaismuutokset Suomessa ja niiden vaikutukset syvällä oleviin kalliopohjavesiin.  
TVO YJT 85-21, Helsinki
- 6-58 Gregersen S, Basham P W (eds)**  
1989  
Earthquakes at north Atlantic passive margins: Neotectonic and glacial rebound.  
NATO ASI C266, Kluwer, London
- 6-59 Holmes R (ed)**  
1989  
Report on a seminar on natural environmental change, April 1988, London.  
Technical Report TR-D&M-13, Dames & Moore, London
- 6-60 Gaál G, Gorbatshev R**  
1987  
An outline of the precambrian evolution of the Baltic Shield.  
Precambrian Research, Vol 35 15-52.
- 6-61 Röshoff K**  
1989  
Characterization of morphology, basement rock and tectonics in Sweden.  
SKB Technical Report TR 89-03, Stockholm
- 6-62 Ziegler P**  
1988  
Evolution of the Arctic-North Atlantic AAPG Memoir 43.  
Tulsa, USA
- 6-63 Slunga R**  
1985  
The seismicity of southern Sweden, 1979-1984, final report.  
FOA Report C 20578-T1, ISSN 0347-3694, Stockholm
- 6-64 Slunga R, Nordgren**  
1987  
Earthquake measurements in southern Sweden, Oct 1, 1986 – March 31, 1987.  
SKB Technical Report TR 87-27, Stockholm
- 6-65 Slunga R**  
1989  
Earthquake measurements in northern Sweden, Oct 1987 – April 1988.  
SKB Technical Report TR 89-xx, Stockholm  
(In print)
- 6-66 Stephansson O**  
1987  
Modelling of crustal rock mechanics for radioactive waste storage in Fennoscandia – Problem definition.  
SKB Technical Report TR 87-11, Stockholm
- 6-67 Kakkuri J**  
1986  
Newest results obtained in studying the Fennoscandian land uplift phenomenon.  
Tectonophysics 130, 327-331
- 6-68 Wakita H, Sano Y, Mizoue M**  
1987  
High <sup>3</sup>He emanations and seismic swarms observed in a non-volcanic, forearc region.  
Journal Geophysical Res 92, No. B12,12539-12546
- 6-69 Ikeya M, Miki T, Tanaka K**  
1982  
Dating of a fault by electron spin resonance on intrafault material.  
Science 1982, V 215, 1392-1393
- 6-70 Tirén S, Beckholmen M**  
1989  
Block faulting in southeastern Sweden interpreted from digital terrain models.  
GFF Vol III, Pt 2, 171-180, Stockholm
- 6-71 Johnston A C**  
1987  
Suppression of earthquakes by large continental ice sheets.  
Nature, 330, 467-469.

**6-72 Mörner N A**  
**1988**  
Kärnavfall i berg är otänkbart.  
("Nuclear waste in rock is unthinkable.")  
(In Swedish)  
Dagens Nyheter DN Debatt. 23 Sept 1988, Stockholm

**6-73 Peltonen E, Ryhänen V H, Salu J P, Vieno T K, Vuori S J**  
**March 1986**  
Concept and safety assessment for spent fuel disposal in Finland. Int. symp. siting, design and construction of underground repositories for radioactive waste.  
Hanover, IAEA-SM-289/28

**6-74 SKBF/KBS**  
**1983**  
Final storage of spent nuclear fuel KBS-3. Volumes I–IV.  
SKBF/KBS, Stockholm

**6-75 Talbot C**  
**1986**  
A preliminary structural analysis of pattern of postglacial faults in northern Sweden.  
SKB Technical Report TR 86-20, Stockholm

**6-76 Lagerbäck R**  
Postglacial faulting and paleoseismicity in the Lansjärv area, northern Sweden.  
SKB Technical Report TR 88-25, Stockholm

**6-77 Wahlström R, Linder S-O, Holmqvist C**  
**1988**  
Near-distance seismological monitoring of the Lansjärv neotectonic fault region.  
SKB Technical Report TR 88-12, Stockholm

**6-78 Stephansson O, Savilahti T**  
**1988**  
Validation of the rock mechanics HNFEMP code against Colorado School of Mines block test data.  
SKB Technical Report TR 88-13, Stockholm

**6-79 Barton N, Chryssanthakis P, Monsen K**  
**1988**  
Validation of MUDEC against Colorado School of Mines block test data.  
SKB Technical Report TR 88-14, Stockholm

**6-80 Röshoff K**  
**1989**  
Seismic effects on underground constructions, groundwater levels and chemistry.  
SKB Technical Report TR 89-xx, Stockholm  
(In print)

**6-81 Nordenskjöld C E**  
**1944**  
Morfologiska studier inom övergångsområdet mellan Kalmar och Tjust.  
("Morphological studies within the transitional area between Kalmar and Tjust.")  
(In Swedish)  
Medd Lunds geol. Inst. Avh VIII. Lund

**6-82 Svensson N**  
**1989**  
Late weichselian and early holocene shore displacements in the central Baltic, based on stratigraphical and morphological records from eastern Småland and Gotland, Sweden.  
Lundqua thesis, Vol. 25, Lund University, Lund

**6-83 Bowman J R**  
**1988**  
Constraints on locations of large intraplate earthquakes in the northern territory, Australia from observations at the Warramunga seismic array.  
Geoph Res Letters, Vol 15, No. 13, 1475–1478

**6-84 Andersson J E, Lindqvist L**  
**1989**  
Prediction of hydraulic conductivity and conductive fracture frequency by multivariate analysis of data from the Klipperås study site.  
SKB Technical Report TR 89-11, Stockholm

## Chapter 7

**7-1 Stumm W, Morgan J**  
**1981**  
Aquatic Chemistry.  
2nd ed. (John Wiley & Sons, New York)

**7-2 Nordstrom D K (ed), Andrews J, Carlsson L, Fontes J, Fritz P, Moser H, Olsson T**  
**July 1985**  
Hydrogeological and hydrogeochemical investigations in boreholes – Final report of Phase 1: Geochemical investigations of the Stripa groundwaters.  
Stripa Project Technical Report TR 85-06, SKB, Stockholm

**7-3 Wikberg P, Axelsen K, Fredlund F**  
**1987**  
Deep groundwater chemistry.  
SKB Technical Report TR 87-07, Stockholm



- 7-4 Magnusson N, Lundqvist G, Ganlund E**  
**1957**  
Sveriges geologi.  
("The geology of Sweden.")  
(In Swedish)  
3rd ed. Nordstedts förlag, Stockholm
- 7-5 Gustafson G, Stanfors R, Wikberg P**  
**1989**  
Swedish Hard Rock Laboratory: Evaluation of 1988 year pre-investigations and description of the target area, the island of Äspö.  
SKB Technical Report TR 89-16, Stockholm
- 7-6 Laaksoharju M, Nilsson A-C**  
**1989**  
Models of groundwater composition and of hydraulic conditions based on chemometrical and chemical analyses of deep groundwater at Äspö and Laxemar.  
SKB Progress Report PR 25-89-04, Stockholm
- 7-7 Wikberg P, Laaksoharju M, Bruno J, Sandino A**  
**September 1988**  
Site characterization and validation – Hydrochemical investigations in Stage I.  
Stripa Project Internal Report IR 88-09, SKB, Stockholm
- 7-8 Neretnieks I**  
**1986**  
"Some uses for natural analogues in assessing the function of a HLW repository" in natural analogues to the conditions around a final repository for high-level radioactive waste.  
Chem. Geol. 55, 175
- 7-9 Wikberg P**  
**1987**  
Thesis: The chemistry of deep groundwaters in crystalline rocks.  
Royal Institute of Technology, Stockholm
- 7-10 Tullborg E-L**  
**1986**  
Fissure fillings from Klipperås study site.  
SKB Technical Report TR 86-10, Stockholm
- 7-11 Laaksoharju M**  
**1988**  
Shallow groundwater chemistry at Laxemar, Äspö and Ävrö.  
SKB Progress Report PR 25-88-04, Stockholm
- 7-12 Nordstrom D K, Puigdomènech I**  
**April 1986**  
Redox chemistry of deep groundwaters in Sweden.  
SKB Technical Report TR 86-03, Stockholm
- 7-13 Puigdomènech I, Nordstrom K**  
**August 1987**  
Geochemical interpretation of groundwaters from Finnsjön, Sweden.  
SKB Technical Report 87-15, Stockholm
- 7-14 Tardy Y, Duplay J, Fritz B**  
**April 1987**  
Stability fields of smectites and illites as a function of temperature and chemical composition.  
SKB Technical Report TR 87-20, Stockholm
- 7-15 Fritz B, Made' B, Tardy F**  
**April 1988**  
Geochemical modelling of the evolution of a granite-concrete-water system around a repository for spent nuclear fuel.  
SKB Technical Report TR 88-18, Stockholm
- 7-16 Andrews J, Fontes J-C, Fritz P, Nordstrom K**  
**August 1988**  
Hydrogeochemical assessment of crystalline rock for radioactive waste disposal: The Stripa experience.  
Stripa Project Technical Report TR 88-05, SKB, Stockholm
- 7-17 Bruno J, Casas I, Grenthe I, Lagerman B**  
**1987**  
Studies on metal carbonate complexes 19. Complex formation in the Th(IV)-H<sub>2</sub>O-CO<sub>2</sub>(g) system.  
Inorganica Chimica Acta 140 (1987) 299-301
- 7-18 Bruno J, Grenthe I, Robouch P**  
**1988**  
Studies of metal carbonate equilibria 21. Formation of tetra carbonate uranium(IV)ion, U(CO<sub>3</sub>)<sub>4</sub><sup>4-</sup>, in hydrogen carbonate solutions.  
Inorganica Chimica Acta (to be published)
- 7-19 Riglet Ch, Vitorge P, Grenthe I**  
**1987**  
Standard potentials of the (MO<sub>2</sub><sup>2+</sup>/MO<sub>2</sub><sup>+</sup>) systems for uranium and other actinides.  
Inorganica Chimica Acta, 133 (1987) 323-329
- 7-20 Grenthe I, Bidoglio G, Omenetto N**  
**1988**  
Use of thermal lensing spectrophotometry (TLS) for the study of mononuclear hydrolysis of uranium(IV).  
Inorganic Chemistry 28 (1989) 71-74

- 7-21 Puigdomènech I, Bruno J**  
**October 1988**  
Modelling of uranium solubilities in aqueous solutions: Validation of a thermodynamic database for the EQ3/6 geochemical codes.  
SKB Technical Report TR 88-21, Stockholm
- 7-22 Bruno J, Puigdomènech I**  
**1988**  
Validation of the SKBUI uranium thermodynamic database for its use in geochemical calculations with EQ3/6 in scientific basis for nuclear waste management XIII; Berlin.
- 7-23 Bruno J, Sandino A**  
**December 1987**  
Radionuclide co-precipitation.  
SKB Technical Report TR 87-23, Stockholm
- 7-24 Tjus K, Wikberg P**  
**March 1987**  
Study of groundwater colloids and their ability to transport radionuclides.  
SKB Technical Report TR 87-12, Stockholm
- 7-25 Marinsky J A, Reddy M M, Ephraim J, Mathuthu A**  
**April 1988**  
Ion binding by humic and fulvic acids: A computational procedure based on functional site heterogeneity and the physical chemistry of polyelectrolyte solutions.  
SKB Technical Report TR 88-04, Stockholm
- 7-26 Moulin V, Robouch P, Vitorge P, Allard B**  
**1987**  
Spectrophotometric study of the interaction between americium(III) and humic materials.  
*Inorganica Chimica Acta* 140(1987)303–306
- 7-27 Allard B, Moulin V, Basso L, Tran M T, Stammose D**  
**1987**  
Americium adsorption on alumina in the presence of humic materials.  
*In impact de la Physico-Chimie sur l'Etude, la conception et l'optimisation de procedes en milieu naturel.*  
*Presses Universitaires de Nancy*, p 277–283
- 7-28 Pedersen K**  
**December 1988**  
Preliminary investigations of deep groundwater microbiology in Swedish granitic rock.  
SKB Technical Report TR 88-01, Stockholm
- 7-29 Torstenfelt B**  
**April 1986**  
Migration of fission products and actinides in compacted bentonite.  
SKB Technical Report TR 86-14, Stockholm
- 7-30 Ittner T, Torstenfelt B, Allard B**  
**January 1988**  
Migration of the fission products strontium technetium, iodine, cesium and the actinides neptunium, plutonium, americium in granitic rock.  
SKB Technical Report TR 88-02, Stockholm
- 7-31 Eriksen T, Locklund B**  
**November 1987**  
Radionuclide sorption on granitic drill core material.  
SKB Technical Report TR 87-22, Stockholm
- 7-32 Eriksen T, Christensen H, Bjergbakke E**  
**March 1986**  
Hydrogen production in alfa irradiated bentonite.  
SKB Technical Report TR 86-04, Stockholm
- 7-33 Eriksen T, Christensen H, Bjergbakke E**  
**1987**  
Hydrogen production in alfa irradiated bentonite.  
*Journal of Radiolytical and Nuclear Chemistry*, Vol. 116 No.1 (1987) 13–25
- 7-34 Eriksen T, Ndalamba P**  
**December 1988**  
On the formation of a moving redox front by alfa radiolysis of compacted water saturated bentonite.  
SKB Technical Report TR 88-27, Stockholm
- 7-35 Eriksen T, Christensen H, Bjergbakke E**  
**December 1988**  
Radiolysis of groundwater: Influence of carbonate and chloride on the hydrogen peroxide production.  
SKB Technical Report TR 88-22, Stockholm
- 7-36 Rasmuson A, Neretnieks I**  
**March 1985**  
Radionuclide transport in fast channels in crystalline rock.  
SKB Technical Report TR 86-13, Stockholm
- 7-37 Tsang Y W, Tsang C F, Neretnieks I**  
**December 1986**  
Some properties of a channelling model of fracture flow.  
SKB Technical Report TR 87-06, Stockholm

**7-38 Moreno L, Tsang Y W, Tsang C F, Neretnieks I**  
**January 1988**  
Flow and solute transport in a single fracture. A two-dimensional statistical model.  
SKB Technical Report TR 88-03, Stockholm

**7-39 Birgersson L, Neretnieks I**  
**April 1988**  
Diffusion in the matrix of granitic rock. Field test in the Stripa mine. Final report.  
SKB Technical Report TR 88-08, Stockholm

**7-40 Zhu M**  
**January 1988**  
Some aspects of modelling of the migration of chemical species in groundwater systems.  
Licentiate Theses, Royal Institute of Technology, Stockholm

**7-41 Zhu M, Rasmusson A, Neretnieks I**  
**July 1988**  
Annual report on chemistry and chemical transport. Report to SKB

**7-42 Eriksen T**  
**December 1988**  
Radionuclide transport in a single fissure. A laboratory flow system for transport under reducing conditions.  
SKB Technical Report TR 88-28, Stockholm

## Chapter 8

**8-1 Gustafsson G, Stanfors R, Wikberg P**  
**1988**  
Swedish Hard Rock Laboratory first evaluation of pre-investigations 1986–87 and target area characterization.  
SKB Technical Report TR 88-16, Stockholm

**8-2 Barmen G, Stanfors R**  
**1988**  
Ground level geophysical measurements on the island of Äspö.  
SKB Progress Report PR 25-88-16, Stockholm

**8-3 Nisca D, Triumf C-A**  
**1989**  
Detailed geomagnetic and geoelectric mapping of Äspö.  
SKB Progress Report PR 25-89-01, Stockholm

**8-4 Ploug C, Klitten K**  
**1988**  
SKB Progress Report PR 25-89-02, Stockholm

**8-5 Almén K-E, Andersson O, Fridh B, Johansson B-E, Sehlstedt M, Gustafsson E, Hansson K, Olsson O, Nilsson G, Axelsen K, Wikberg P**  
**1986**

Site investigation – Equipment for geological, geophysical, hydrogeological and hydrochemical characterization.  
SKB Technical Report TR 86-16, Stockholm

**8-6 Strähle A**  
**1988**  
Drill core investigation in the Simpevarp area, boreholes KAS 02, KAS 03, KAS 04 and KLX 01.  
SKB Progress Report PR 25-88-07, Stockholm

**8-7 Sehlstedt S, Strähle A**  
**1988**  
Geological core mapping and geophysical borehole logging in the boreholes KAS 05 – KAS 08 at Äspö.  
SKB Progress Report PR 25-89-09, Stockholm

**8-8 Olsson O, Falk L, Forslund O, Lundmark L, Sandberg E**  
**1987**  
Crosshole investigations – results from borehole radar investigations.  
Stripa Project Technical Report TR 87-11, SKB, Stockholm

**8-9 Olsson O, Eriksson J, Falk L, Sandberg E**  
**1988**  
Site characterization and validation – Borehole radar investigations, Stage 1.  
Stripa Project Technical Report TR 88-03, SKB, Stockholm

**8-10 Cosma C**  
**1987**  
Crosshole investigations – Short and medium range seismic tomography.  
Stripa Project Technical Report TR 87-08, SKB, Stockholm

**8-11 Stenberg L**  
**1987**  
Detailed investigations of fracture zones in the Brändan area, Finnsjön study site. Investigations with the tubewave method in boreholes Fi 6 and BFi 1.  
SKB Work Report AR 87-27, Stockholm

**8-12 Nilsson L**  
**1988**  
Hydraulic tests at Äspö and Laxemar – Evaluation.  
SKB Progress Report PR 25-88-14, Stockholm

**8-13 Rhén I  
1989**

Transient interference tests on Äspö.  
SKB Progress Report PR 25-88-13, Stockholm

**8-14 Gustafson E  
1987**

Groundwater flow measurements in fractured crystalline rock by point dilution.  
SKB Technical note

**8-15 Laaksoharju M, Nilsson A-C  
1989**

Chemical characterization and modelling of deep groundwater at Äspö and Laxemar.  
SKB Progress Report PR 25-89-04, Stockholm

**8-16 Wikberg P  
1987**

The chemistry of deep groundwaters in crystalline rocks.  
Royal Institute of Technology, Stockholm

**8-17 Ahlbom K, Andersson P, Ekman L, Tirén S  
1988**

Characterization of fracture zones in the Brändan area Finnsjön study site, central Sweden.  
SKB Work Report AR 88-09, Stockholm

**8-18 Abelin H, Birgersson L, Gidlund J  
1987**

3-D Migration experiment – Report 2, instrumentation and tracers.  
Stripa Project Technical Report TR 87-20, SKB, Stockholm

**8-19 Bjarnason B, Torikka A  
1989**

Field instrumentation for hydrofracturing stress measurements.  
SKB Technical Report TR 89-17, Stockholm

**8-20 Carlsten S, Olsson O, Persson O, Sehlstedt M  
1988**

Site characterization and validation – Monitoring of head in the Stripa mine during 1987.  
Stripa Project Internal Report IR 88-02, SKB, Stockholm

**8-21 Holmes D, Sehlstedt M  
1987**

Crosshole investigations – Details of the construction and operation of the hydraulic testing system.  
Stripa Project Technical Report TR 87-04, SKB, Stockholm

## Chapter 9

**9-1 Gustafson G, Stanfors R, Wikberg P  
1988**

Swedish Hard Rock Laboratory – First evaluation of pre-investigations 1986-87 and target area characterization.  
SKB Technical Report TR 88-16, Stockholm

**9-2 Gustafson G, Stanfors R, Wikberg P  
1989**

Swedish Hard Rock Laboratory – Evaluation of 1988 pre-investigations and description of the target area, the island of Äspö.  
SKB Technical Report TR 89-16, Stockholm

## Chapter 10

**10-1 Executive Summary of Phase 1  
July 1986**

Stripa Project Technical Report TR 86-04, SKB, Stockholm

**10-2 Executive Summary of Phase 2  
February 1989**

Stripa Project Technical Report TR 89-01, SKB, Stockholm

**10-3 Program for the Stripa Project Phase 3 1986–1991  
May 1987**

Stripa Project Technical Report TR 87-09, SKB, Stockholm

**10-4 Holmes D, Sehlstedt M  
May 1986**

Crosshole investigations – Details of the construction and operation of the hydraulic testing system.  
Stripa Project Technical Report TR 87-04, SKB, Stockholm

**10-5 Olsson O, Falk L, Forslund O, Lundmark L, Sandberg E  
May 1987**

Crosshole investigations – Results from borehole radar investigations.  
Stripa Project Technical Report TR 87-11, SKB, Stockholm

**10-6 Bjarnason B, Raillard G  
July 1987**

Rock stress measurements in borehole V3.  
Stripa Project Internal Report IR 87-13, SKB, Stockholm

- 10-7 Fridh B**  
**December 1987**  
 Site characterization and validation – Geophysical single hole logging.  
 Stripa Project Technical Report TR 87-17, SKB, Stockholm
- 10-8 Black J, Holmes D, Brightman M**  
**December 1987**  
 Crosshole investigations – Hydrogeological results and interpretations.  
 Stripa Project Technical Report TR 87-18, SKB, Stockholm
- 10-9 Noy D, Barker J, Black J, Holmes D**  
**February 1988**  
 Crosshole investigations – Implementation and fractional dimension interpretation of sinusoidal tests.  
 Stripa Project Technical Report TR 88-01, SKB, Stockholm
- 10-10 Carlsten S, Olsson O, Persson O, Sehlstedt M**  
**April 1988**  
 Site characterization and validation – Monitoring of head in the Stripa mine during 1987.  
 Stripa Project Internal Report IR 88-02, SKB, Stockholm
- 10-11 Olsson O, Eriksson J, Falk L, Sandberg E**  
**April 1988**  
 Site characterization and validation – Borehole radar investigations, Stage I.  
 Stripa Project Technical Report TR 88-03, SKB, Stockholm
- 10-12 Cosma C, Korhonen R, Hammarström M, Norén P, Pihl J**  
**September 1988**  
 Site characterization and validation – Results from seismic crosshole and reflection measurements, Stage 1.  
 Stripa Project Internal Report IR 88-07, SKB, Stockholm
- 10-13 Vik G, Barton N**  
**August 1988**  
 Stage 1 Joint characterization and Stage 2 Preliminary prediction using small core samples.  
 Stripa Project Internal Report IR 88-08, SKB, Stockholm
- 10-14 Wikberg P, Laaksoharju M, Bruno J, Sandino A**  
**September 1988**  
 Site characterization and validation – Hydrochemical investigations in Stage 1.  
 Stripa Project Internal Report IR 88-09, SKB, Stockholm
- 10-15 Gale J, Stråhle A**  
**September 1988**  
 Site characterization and validation – Drift and borehole fracture data, Stage I.  
 Stripa Project Internal Report IR 88-10, SKB, Stockholm
- 10-16 Olsson O, Black J, Gale J, Holmes D**  
**May 1989**  
 Site characterization and validation Stage 2 – Preliminary predictions.  
 Stripa Project Technical Report TR 89-03, SKB, Stockholm
- 10-17 Abelin H, Neretnieks I, Tunbrant S, Moreno L**  
**May 1985**  
 Final report of the migration in a single fracture – Experimental results and evaluation.  
 Stripa Project Technical Report TR 85-03, SKB, Stockholm
- 10-18 Abelin H**  
**1986**  
 Migration in a single fracture. An in-situ experiment in a natural fracture.  
 Ph.D. Thesis, Department of Chemical Engineering, Royal Institute of Technology, Stockholm
- 10-19 Annual Report 1988**  
**May 1989**  
 Stripa Project Technical Report TR 89-05, SKB, Stockholm
- 10-20 State-of-the-art report on potentially useful materials for sealing nuclear waste repositories**  
**June 1987**  
 Stripa Project Technical Report TR 87-12, SKB, Stockholm
- 10-21 Pusch R, Börgesson L, Fredrikson A, Markström I, Erlström M, Ramqvist G, Gray M, Coons W**  
**September 1988**  
 Rock sealing – Interim report on the rock sealing project (Stage I).  
 Stripa Project Technical Report TR 88-11, SKB, Stockholm
- 10-22 Pusch R**  
**March 1988**  
 Rock sealing – Large scale field test and accessory investigations.  
 Stripa Project Technical Report TR 88-04, SKB, Stockholm

## Chapter 11

### 11-1 IAEA 1987

A review of the use of natural analogues in performance assessments of deep underground repositories for long-lived radioactive wastes.  
IAEA Technical Report Series (8000W), Vienna

### 11-2 Goodwin B W, Cramer J J, McConnell D B 1988

The Cigar Lake uranium deposit; An analogue for nuclear fuel waste disposal.  
In third CEC meeting of the Natural Analogue Working Group (NAWG) Snowbird, Utah, June 15–17

### 11-3 Smellie J 1988

Swedish natural analogue studies and their applications.  
In joint Sino-Japanese seminar on the implication of natural analogues to the safety of radioactive waste disposal. Organized by Taiwan Radwaste Administration – Energy Council. Taipei, Taiwan, December 9.

## Chapter 12

### 12-1 Evans S October 1986

Quantitative estimates of sedimentation rates and sediment growth in two Swedish lakes.  
Studsvik Energiteknik AB, Nyköping.  
SKB Technical Report TR 86-29, Stockholm

### 12-2 Sundblad B December 1986

Recipient evolution – Transport and distribution of elements in the lake Sibbo-Trobbofjärden area.  
Studsvik Energiteknik AB, Nyköping.  
SKB Technical Report TR 86-30, Stockholm

### 12-3 Andersson K August 1987

Watercomposition in the Lake Sibbofjärden, Lake Trobbofjärden area.  
Studsvik Energiteknik AB, Nyköping.  
SKB Technical Report TR 87-30, Stockholm

### 12-4 Bergström U, Evans S, Puigdomènech I, Sundblad B September 1988

Long-term dynamics of a lake ecosystem and the implications for radiation exposure.  
Studsvik Nuclear, Nyköping.  
SKB Technical Report TR 88-31, Stockholm

### 12-5 Carbol P, Eriksson N, Gustafsson E, Ittner T, Karlberg, O, Lampe S, Skålberg M, Sundblad B, Tullborg E-L December 1987

Radionuclide deposition and migration within the Gideå and Finnsjön study sites, Sweden: A study of the fallout after the Chernobyl accident. Phase I, initial survey.  
SKB Technical Report TR 87-28, Stockholm

### 12-6 Ittner T, Gustavsson E 1989-03-01

Lägesrapport avseende 1988 års aktiviteter inom projektet; Nedfallsstudier i Gideå och Finnsjön-området efter Tjernobylyolyckan 1986.  
("Status report concerning 1988 activities within the project: Fallout studies in Gideå and the Finnsjön area after the Chernobyl accident in 1986.")  
(In Swedish)  
Work Report SGAB 89209

### 12-7 Dames and Moore January 1989

Report of a seminar on "Natural environmental change".  
UKDOE Report No. DOE/RW/89.029

### 12-8 Carbol P, Ittner T, Skålberg M 1988

Radionuclide deposition and migration of the Chernobyl fallout in Sweden.  
Radiochimica Acta 44/45, 207–212

### 12-9 Suolanen V, Vieno T September 1987

Development of biosphere scenarios for safety analysis of spent nuclear fuel disposal.  
Nuclear Waste Commission of Finnish Power Companies.  
Report YJT-87 – 13

### 12-10 Elert M, Argärde A-C 1985

Modelling of the interface between the geosphere and the biosphere – Discharge through a sediment layer.  
Project SSI P295-84.  
Swedish National Institute of Radiation Protection, Stockholm

### 12-11 Elert M, Argärde A-C, Ericsson A-M December 1988

Modelling of the interface between the geosphere and the biosphere: Discharge through a soil layer.  
Kemakta Konsult AB, Stockholm.  
KEMAKTA AR 88-23

**12-12 Häss C, Johansson G**  
**1987**

BIOMOVS: An international model validation study.  
SSI Report 87-32

**12-13 Thorne M C**  
**June 1988**

The biosphere: Current status.  
Electrowatt Engineering Services (UK) LTD, West  
Sussex.  
HL89/1085

## Chapter 13

**13-1 JSS Project Phase IV: Final Report**  
**1987**

Experimental and modelling studies of HLW glass dis-  
solution in repository environments.  
JSS Project Technical Report 87-01, SKB, Stockholm

**13-2 Grambow B**  
**1987**

Nuclear waste glass dissolution: Mechanism, model  
and application.  
JSS Project Technical Report 87-02, SKB, Stockholm

**13-3 JSS Project Phase V: Final Report**  
**1988**

Testing and modelling of the corrosion of simulated  
nuclear waste glass powders in a waste package en-  
vironment.  
JSS Project Technical Report 88-02, SKB, Stockholm

**13-4 Jercinovic M J, Ewing R C**  
**1988**

Basaltic glasses from Iceland and the deep sea: Natural  
analogues to borosilicate nuclear waste-form glass.  
JSS Project Technical Report 88-01, SKB, Stockholm

**13-5 Thunvik R, Braester C**  
**1988**

GWHRT – A flow model for coupled groundwater and  
heat flow version 1.0.  
SKB Technical Report TR 88-10, Stockholm

**13-6 Thunvik R**  
**1987**

Calculations on HYDROCOIN Level 2, case 1 using  
the GWHRT flow model. Thermal convection and  
conduction around a field heat transfer experiment.  
SKB Technical Report TR 87-04, Stockholm

**13-7 Larsson N-Å, Markström A**  
**1988**

Groundwater numerical modelling of the Fjällveden  
study site – Evaluation of parameter variations. A  
HYDROCOIN study – Level 3, Case 5A.  
SKB Technical Report 88-11, Stockholm

**13-8 Wanner H**  
**1988**

The NEA Thermodynamical Data Base Project.  
OECD/NEA Report TDB-0

**13-9 Wanner H**  
**1988**

Guidelines for the review procedure and data selec-  
tion.  
OECD/NEA Report TDB-1

**13-10 Grenthe I, Wanner H**  
**1988**

Guidelines for the extrapolation to zero ionic strength.  
OECD/NEA Report TDB-2

**13-11 Wanner H**  
Guidelines for the assignment of uncertainties.  
OECD/NEA Report TDB-3

**13-12 Wanner H**  
Standards and conventions for TDB publications.  
OECD/NEA Report TDB-5